

Operating instructions for condenser tumble dryer T 494 C

It is **essential** to read these operating instructions before installing or using the machine to avoid the risk of accident, or damage to the machine.



Contents

Guide to the appliance	4
Caring for the environment	6
Warning and safety instructions	7
Brief instructions	10
Notes on laundry care	11
How to dry correctly	
Hints on saving energy	12
❶ Switching on and loading	12
❷ Selecting a programme	13
❸ Selecting additional option(s)	13
❹ Starting a programme	13
After drying	14
Altering a programme	15
Programme chart	16
Programmable functions	
Notes	18
Correcting the drying level	18
Buzzer	18
Memory	18
Anti-crease	18
Activating and storing in the memory	19

Cleaning and care

Cleaning the fluff filters.	20
Cleaning the tumble dryer	20
Emptying the condensed water container	21
Cleaning the condenser unit	22

Problem solving guide

What to do if	24
-----------------------------	----

After sales service

Repairs.	28
Future updates.	28

Installation

Installation	29
External condensed water outlet	30

Electrical connection	32
--	----

Consumption data	33
-----------------------------------	----

Technical data	34
---------------------------------	----

Guide to the appliance

General view

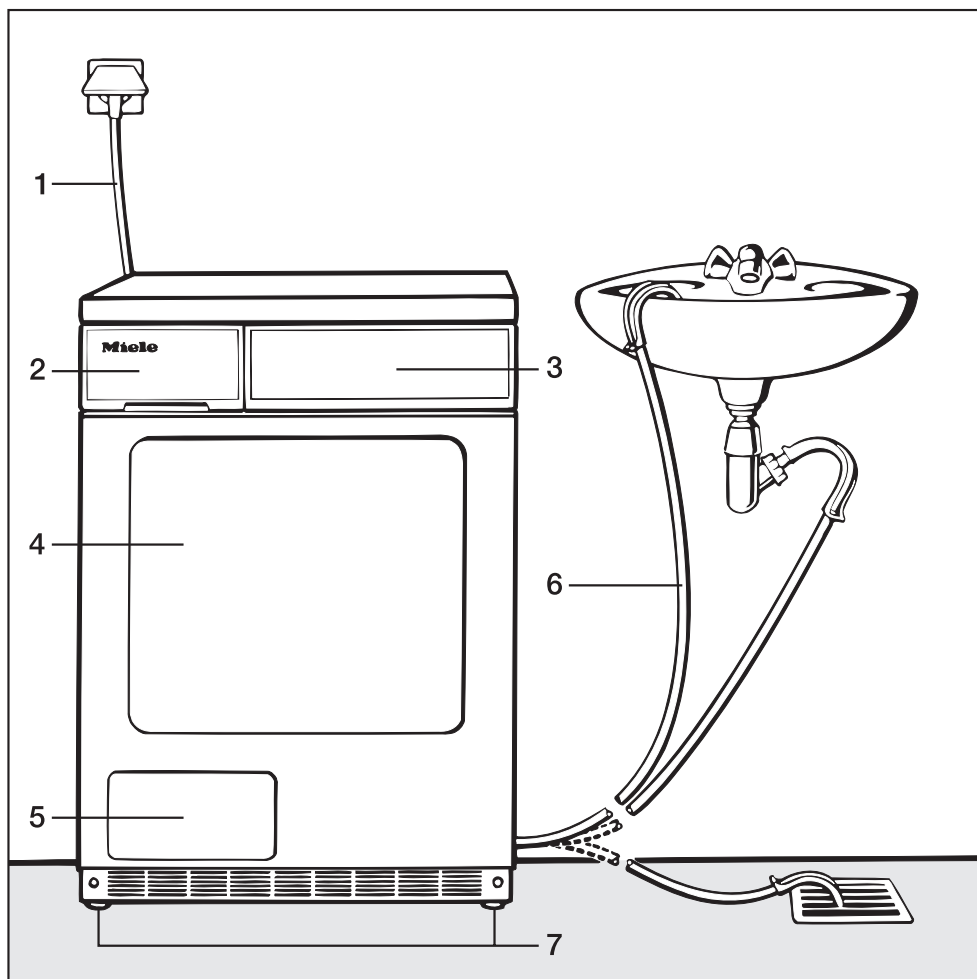

- 1** Supply cable for electrical connection
- 2** Condensed water container
- 3** Control panel
- 4** Door
- 5** Condenser unit cover
- 6** Drain hose for condensed water (if fitted)
- 7** Four height-adjustable screw feet

Control panel

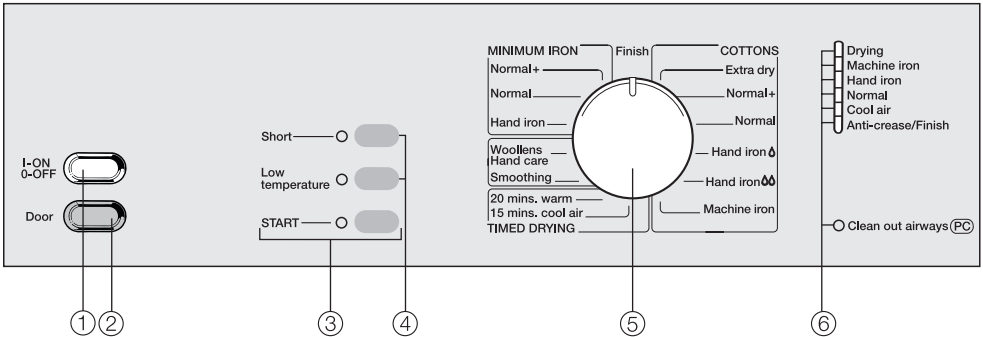

① “I-On/0-Off” button

for switching the appliance on and off. When the machine is switched on, the drum light will come on as you open the door.

② “Door” button

to open the door/cancel a programme. This button does not stay pressed in.

③ “START” button

starts a drying programme. The indicator light:

- flashes to indicate that the programme can be started;
- remains on once the programme has commenced.

④ Additional option buttons

Indicator lights: **on**= option selected
off= option not selected

⑤ Programme selector

can be turned clockwise or anti-clockwise.

⑥ Sequence indicator and check lights

Please consult the section “Problem solving guide” for the check lights.

Caring for the environment

Disposal of packing

The transport and protective packing has been selected from materials which are environmentally friendly for disposal and can normally be recycled. Rather than just throwing these materials away, please ensure they are offered for recycling.

Disposal of your old machine/appliance

Old machines/appliances contain materials which can be recycled. Please contact your dealer, your local waste collection centre or scrap merchant about potential recycling schemes. Ensure that the machine/appliance presents no danger to children while being stored for disposal. See the appropriate advice in the "Warning and safety" instructions.

Warning and safety instructions

Please read the operating instructions before using the tumble dryer for the first time. They contain important information about the safety, use and maintenance of the machine. This will avoid the risk of accidents and damage to the machine. Keep these operating instructions in a safe place and ensure that new users are familiar with the content. Pass them on to any future owners of the machine.

Correct usage

The tumble dryer is only intended for drying fabrics which have been washed in a water solution and are marked on the manufacturer's wash care label as being suitable for tumble drying.

Any other applications may be dangerous. The manufacturer is not liable for damage resulting from improper use or operation.

Do not let small children play with the machine and its controls or operate it. Please supervise its use by the elderly or infirm.

Technical safety

Check for visible external damage before installation.

Do not install or operate a damaged machine or appliance.

Before connecting the machine, ensure that the connection data on the data plate (fusing, voltage and frequency) matches the mains electricity supply. If in any doubt, consult a qualified electrician.

The electrical safety of this machine can only be guaranteed when continuity is complete between the appliance and an effective earthing system which complies with local and national regulations. It is most important that this basic safety requirement is regularly tested by a qualified electrician. The manufacturer cannot be held responsible for the consequences of an inadequate earthing system.

The machine is built in accordance with current safety requirements. Unauthorised repairs could result in unforeseen dangers for the user, for which the manufacturer cannot accept responsibility. Repairs should only be undertaken by a Miele approved engineer.

In the event of a fault, or for cleaning purposes, the machine is only completely isolated from the electricity supply when:

- the plug is withdrawn, or
- it is switched off at the mains, or
- the mains fuse is withdrawn.

Warning and safety instructions

■ For safety reasons, do not use an extension cable. There is a danger of overheating.

■ Faulty components must only be exchanged for Miele original spare parts. Only when these parts are fitted can the safety standards of the machine be guaranteed.

Use

■ This equipment is not designed for maritime use or for use in mobile installations such as caravans, aircraft etc. However, it may be suitable for such usage subject to a risk assessment of the installation being carried out by a suitably qualified engineer.

■ Do not install the machine in a room where the temperature may drop below freezing, as temperatures below zero could damage the machine.

Frozen condensed water in the pump, hose and condensed water container could also lead to damage.

■ If the water is drained externally through the drain hose instead of being collected in the condensed water container, make sure the drain hose is securely attached if you hang it in a sink or basin to avoid the hose slipping and the water causing damage.

■ Condensed water is not drinking water. It can cause health problems in people and animals.

■ Always close the door after use to avoid the danger of:

- someone leaning on the door which could cause the machine to tip;
- children climbing into the machine or hiding objects in it.

■ There is a danger of fire with fabrics which:

- contain rubber, foam rubber or rubber-like materials;
- have been treated with inflammable cleaning agents;
- have been splashed with hair lacquer, hair spray, nail varnish remover or similar;
- also padded items (eg cushions, jackets) which have been damaged, as the padding could fall out and catch fire;
- are soiled with grease or oil.

■ Always keep the area around the machine free of dust and fluff.

■ In countries where there are areas which may be subject to infestation by cockroaches or other vermin, pay particular attention to keeping the appliance and its surroundings in a clean condition at all times. Any damage which may be caused by cockroaches or other vermin will not be covered by the appliance guarantee.

Using accessories

■ Accessory parts may only be fitted when expressly approved by Miele. If other parts are used, guarantee, performance and product liability claims may be invalidated.

Disposing of your old machine

■ Before discarding an old machine, unplug it and render the plug useless. Cut off the cable directly behind the appliance to prevent misuse.

Brief instructions

Brief description

Programmes are selected by turning the **programme selector** and can be supplemented by pressing the **additional option** buttons.

Press the “**START**” button to begin a programme.

The **indicator lights** in the sequence display (on the right hand side of the control panel) show which stage has been reached in the programme.

The **Sensitive system** automatically adjusts drying to suit the water quality and ensure more precise results.

The **Novotronic controls** measure and register the conductivity of the water and compensate for variations to achieve a uniform residual moisture level.

The **automatic reversing action** turns the drum clockwise and anti-clockwise to loosen the laundry and prevent uneven drying, ensuring good results.

Once the required degree of dryness is achieved, the laundry is allowed to cool down.

At the end of the programme the **anti-crease action** period begins. The drum turns intermittently to reduce the formation of creases and folds.

Programmable functions can be used to select or de-select some of the additional options and introduce further functions. These combinations can be stored in the machine’s memory and called up.

Please read the sections on “Warning and safety” and “Notes on laundry care”.

① Switching the machine on and loading the laundry

- Switch on by pressing the “I-On/0-Off” button.
- Press the “Door” button to open the door.
- Place the laundry loosely in the drum.
- Close the door.

② Selecting a programme

- Turn the programme selector to the drying level you require.

③ Selecting additional options



- Press the buttons to switch additional options on or off as required.

④ Starting the programme

- Press the “START” push button.

Before drying, check the drying symbol on the textile care label.

Significance of symbols:

-  = Dry at normal temperature
-  = Dry at low temperature
(also push in the "Low temperature" button if required)
-  = Do not tumble dry

If no symbol is featured, dry at your own risk applying the following principles:

Cotton and minimum iron items should be dried in the appropriate programme (see programme charts).

For delicate fabrics, eg acrylic, select "Minimum iron" and also press the "Low temperature" button.

Never overload the drum. Always observe the maximum recommended loads given in the "Programme chart". Overloading can cause unnecessary wear and tear to the laundry, give a disappointing drying result and cause more creasing.

The following fabrics should not be dried in a tumble dryer:

– Woollens and wool blends

These fabrics tend to become matted and shrink. These fabrics can, however, be partially dried using the "Woollens hand care" programme.

– Down-filled items*

The fine fabric interior tends to shrink, depending on the quality.

– Pure linen*

These items should only be machine dried if specified as suitable by the manufacturer on the textile care label, as the surface of the fabric may otherwise "roughen".

* Linen and down-filled items can, however, be partially dried using the "Smoothing" programme.

Notes:

Some woven and loopknit materials (eg T-shirts, cotton jersey material) have a tendency to shrink, depending on their quality, and this is often made worse by over-drying. When purchasing woven materials, it is advisable to take their shrinkage properties into account.

Starched washing can be dried in the tumble dryer. In order to achieve the usual finish, double the amount of starch should be used.

Minimum iron fabrics and 100% cotton shirts or blouses tend to crease more, when larger loads being dried, particularly when the weave of the fabric is very fine. Reduce the load or use the Special care "Minimum iron – Hand iron" programme. If this is unsatisfactory use the "Smoothing" setting, then hang the garments on a hanger to dry.

New dark-coloured fabrics should be dried separately from light-coloured fabrics to avoid colours running.

How to dry correctly

Hints on saving energy

- Make sure that your laundry has been thoroughly spun at the highest appropriate spin speed before drying. Spinning at 1600 rpm, for example, saves approximately 30% energy and time compared with 800 rpm.
- Load the full amount of laundry according to the programme chosen (see “Programme chart”) for the most economical drying related to the size of the load. **Make sure that the drum is not over- or underloaded.**
- As far as possible, sort fabrics for:
 - the type of fibre or weave
 - the degree of drying required
 - similar size of items
 - the moisture content after spinning.This will help towards an even drying result.

- Ensure the room is well ventilated.

① Switching on and loading

- Fasten duvet covers etc to prevent small items from being rolled up inside them.
- Do up zips and tie fabric belts and apron strings.
- Press the “I-On / 0-Off” button.
- Press the “Door” button and open the door.

Make sure there is no washing detergent dispenser among the laundry, as this could melt and damage the machine and the laundry.

- Load the laundry very loosely into the drum.

Do not overload the drum. Overloading can cause unnecessary wear and tear to the laundry and give a disappointing drying result.

- Close the door.

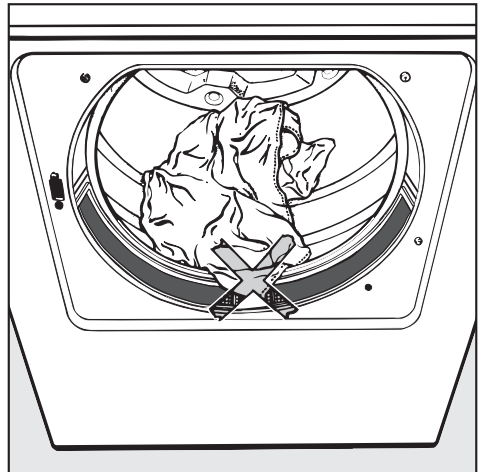

Important: Please check that items of laundry cannot be trapped by the door, as this will cause damage to the fabric.

2 Selecting a programme

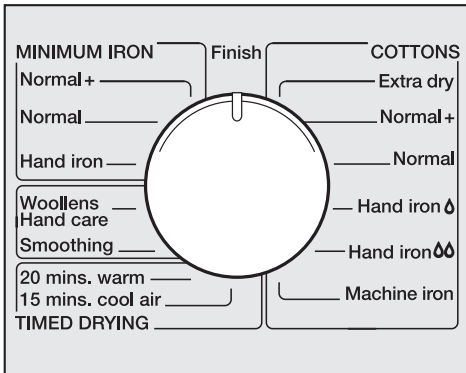

- Turn the programme selector to the programme required.

See the “Programme chart” for a description of each programme.

3 Selecting additional option(s)

- Additional options are switched on or off by pressing the appropriate buttons.

Indicator lights:

- **on**= additional option selected
- **off**= additional option not selected

Short

The programme running time is reduced.

- For drying fabrics that are not delicate.

Low temperature

The drying temperature is reduced.

- For delicate fabrics (drying symbol ☺), eg acrylic.

The programme running time is increased.

4 Starting a programme

- Press the “START” button.

The drying stage reached display on the right hand side of the facia panel will indicate which drying stage the programme has reached.

The memory function:

If the memory function has been activated, the machine will automatically call up the additional options selected for the last programme used. The indicator lights will indicate which options are selected.

For further details on the memory function, please see the section “Programmable functions”.

How to dry correctly

"Clean out airways" indicator light

This indicator light shows that the dryer is not working most efficiently or economically.

The causes of this check message can be:

- the fluff filters in the door and the secondary filters in the door opening are blocked;
- the condenser unit is blocked.

The "Clean out airways" check light will only go out before the start of a programme if the dryer has been switched off with the "I-On/0-Off" button.

After drying

When the drying programme has finished the "Anti-crease / finish" sequence indicator light comes on.

- Press the "Door" button to open the door.
- Remove the laundry.
- Make sure that the drum is empty.

If items are left in the dryer, they could be damaged by overdrying when the dryer is next used.

- After every cycle remove the fluff from
 - the fluff filter in the door
 - the filters in the door opening (See the section on "Cleaning and care").
- Empty the condensed water container (where there is no external drainage of the water). See the section on "Cleaning and care".

Close the door and switch off the machine after each use.

- Press the "I-On / 0-Off" button to switch off.

Once a programme has started, no changes to the programme or additional options will be accepted.

If the programme selector is turned to a different programme after a programme has begun, the “Drying” indicator light will flash. The programme originally selected will continue to run as normal. The indicator light will go out when the selector is returned to its original position.

To cancel a programme

- Open the door or switch off the machine.

To select a different programme

- Turn the programme selector to “Finish”.
- The “Anti-crease/Finish” indicator light will flash by itself to indicate that the programme has been cancelled.
- Turn the programme selector to the drying level required.
- Switch additional options on or off as required.
- Press the “START” button.

To open the door during a programme to add or remove garments

Cancel the programme by:

- Pressing the “Door” button and opening the door.
- Items can now be added or removed early.

Restart the programme by:

- Closing the door.
- Pressing the “START” button.
- The programme will restart.

If there is a power cut, TIMED DRYING programmes have to be restarted once the power supply is restored.

Programme chart

Programme	Fabric type	maximum load ⁽²⁾	Special notes
-----------	-------------	-----------------------------	---------------

COTTONS			
Extra dry	Multi-layered fabrics, not thoroughly dried with "Normal +"	5 kg	Do not dry jersey wear in the Extra dry programme – tendency to shrink.
Normal +	Mixed load of cotton fabrics, eg towelling, jerseywear, ie single and multi-layered fabrics.	5 kg	–
Normal ⁽¹⁾	Load of similar fabrics (jersey wear, flannelette sheets, towelling).	5 kg	If fabrics are too damp, select "Normal +".
Hand iron Δ	Cotton or linen fabrics (eg table linen, bedlinen, starched laundry etc)	5 kg	–
Hand iron $\Delta\Delta$ ⁽¹⁾		5 kg	If laundry is still too damp for hand ironing, then select "Hand iron Δ " in the future.
Machine iron	Cotton or linen fabrics, including starched laundry, for machine ironing	5 kg	The laundry should be rolled up to prevent it from drying out until it can be ironed.
MINIMUM IRON			
Normal+	Minimum iron items which are made of synthetics or blended fabrics, (eg pullovers, dresses, trousers) which are not dried adequately in the "Normal" programme	2.5 kg	Spin minimum iron fabrics for at least 30 seconds in the washing machine before drying.
Normal ⁽¹⁾	Minimum iron shirts, Table cloths etc made of blended fabrics, (eg cotton/synthetics) .	2.5 kg	
Hand iron	Minimum iron shirts, Table cloths etc made of blended fabrics, (eg cottons and synthetics), which are still to be hand ironed.	2.5 kg	Spin minimum iron fabrics for at least 30 seconds in the washing machine before drying. For extra special care of delicate fabrics and to reduce creacing even more, reduce the load to 1 kg.

⁽¹⁾ Note for Test Institutes: These are the programmes that should be tested according to the EN 61121/A11 Standard.

⁽²⁾ Weight of dry laundry

Programme chart

Programme	Fabric type	Maximum load ⁽²⁾	Special notes
-----------	-------------	-----------------------------	---------------

TIMED DRYING

Warm air	Individual items, (eg bathing costumes, bath towels, tea towels) Multi-layered fabrics whose layers have different drying characteristics.	5 kg	–
Cool air	Items which are only to be aired	5 kg	–

Special care programmes

Woollens hand care	Woollen fabrics	1 kg	To refresh and fluff up woollen garments quickly. Remove garments immediately at the end of the programme. Do not repeat. Woollen fabrics are not dried completely by this programme.
Smoothing	Minimum iron items made of cotton, blended fabrics or synthetics	2.5 kg	Smooths out creases caused during the spin cycle in the washing machine. Fabrics are not dried completely in this programme. Remove garments immediately at the end of the programme and hang on a line or coat hangers to dry.

⁽²⁾ Weight of dry laundry

Programmable functions

Notes

The programmable functions can be used to create drying programmes to suit your individual requirements. They will remain in the machine's memory until cancelled.

- One or all of the programmable functions can be activated or cancelled (See following page).

Correcting the drying level

The Sensitive System aims to dry using as little energy as possible. However, if you require the washing to be drier, it is possible to reduce the final moisture level on all programmes. (It is not possible to alter an individual programme).

The machine is delivered with this function switched off.

Buzzer

An audible tone sounds repeatedly at the end of a programme.

The machine is delivered with the buzzer switched on, but it can be switched off (see next page).

The volume of the buzzer can be altered (the pitch changes at the same time).

Proceed as follows:

1. Select the programmable function "Buzzer" (see next page, points ❶ to ❷).

2. Press the "START" button. The indicator light for "**machine iron**" goes out.
3. Press the "START" button again and **keep it pressed in**. The indicator light for "**machine iron**" will light up.
4. Release the "START" button when the volume you want is reached.
5. Turn the programme selector to the "Finish" position.
6. Switch the machine off with the "I-On/0-Off" button.
The change to the volume has been stored in memory.

To switch the buzzer off altogether see the next page (points ❶ to ❷).

Memory

The additional options selected previously for specific programmes are stored in the machine's memory.

The memory programmable function can be used to switch the memory function on or off. The machine is delivered with the memory function activated.

Anti-crease

Once a programme has ended, the drum will turn at regular intervals to prevent the laundry from settling into creases and folds.

This programmable function can be used to switch the memory function on or off. The machine is delivered with the "Anti-crease" function activated.

Activating and storing in the memory

The programmable functions are activated using the additional option buttons in special combinations with the programme selector to introduce extra features not marked up on the control panel.

- ❶ Switch the machine off and shut the door.
Turn the programme selector to “Finish”.
- ❷ Press the “Short” and “Low temperature” buttons in. Hold them there and ...
- ❸ ... switch the machine on by pressing the “I-On / 0-Off” button.
- ❹ Release all the buttons.
- ❺ The “Drying” and “Cool air” indicator lights will flash.
- ❻ Turn the programme selector to one of the following positions:
 - COTTONS / Extra dry for the function “Correcting the drying level”
 - COTTONS / Normal + for the function “Buzzer”
 - COTTONS / Normal for the “Memory function”
 - COTTONS / Hand iron  for the function “Anti-crease”

- ❼ If the “Machine iron” indicator light comes on, then the chosen function has been activated.
- ❽ Each programmable function can be switched on or off by pressing the “START” button:
 - “Machine iron” indicator light
 - on = Programmable function activated
 - off = Programmable function de-activated.
- ❾ If you wish to activate a further programmable function, repeat steps ❹ to ❽. If not:
- ❿ To store in the memory: Turn the programme selector to “Finish” and switch the machine off by pressing the “I-On/0-Off” button.

To de-select a programmable function

- Carry out steps ❶ to ❿.

To check whether a programmable function is activated:

- Carry out steps ❶ to ❷.
- Switch the machine off.

This completes the check.

Cleaning and care

Cleaning the fluff filters

The fluff which is created by the drying process is collected in the fluff filters in the door and door opening.

- Clean the filters after every programme to reduce drying time and save energy.

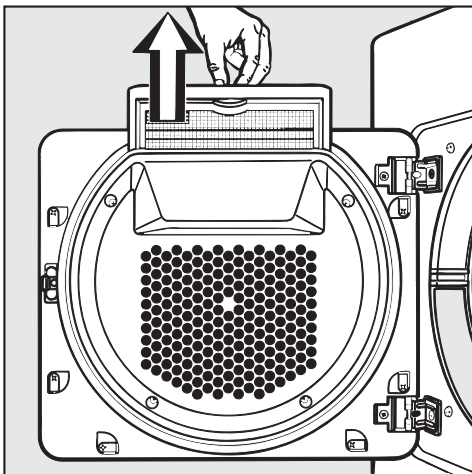

- Open the door. Grip the filter by the recessed handle and pull upwards to remove.
- Remove the fluff from:
 - the filter in the door
 - the filters in the door opening**Do not use any sharp or pointed objects.**
- Remove any fluff from the hollow part of the door holder through the wide slit at the bottom. A cleaning brush is available at extra cost from the Miele Spare Parts Department.
- Push the cleaned filter back into the door holder and close the door.

If there is a great deal of compacted fluff on the filters, they can be cleaned under hot running water.

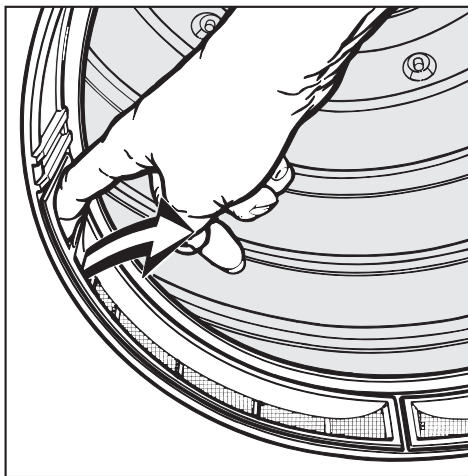

- These filters should only be removed for cleaning with water.
- Dry the filters well after rinsing and put back in place.

Cleaning the tumble dryer

Disconnect the machine from the power supply.

- Clean . . .
 - . . . **the housing and control panel:** with a mild detergent or soapy water;
 - . . . **the drum and other stainless steel parts:** with a suitable proprietary stainless steel cleaner following the manufacturer's instructions.

Never use abrasive substances, scouring pads, glass or general purpose cleaners. These could damage plastic surfaces and other parts. The machine must never be hosed down.

- Dry all parts with a soft cloth.

Emptying the condensed water container

If the hose drain has not been fitted and connected, the condensed water will be collected in the condensed water container.

The condensed water container should be emptied after every drying cycle, or as soon as the "Empty out container" indicator light comes on.

If . . .

. . . the condensed water container is full when a programme is started or . . . it becomes full during a drying cycle:

- the "Empty out container" light will come on,
- the buzzer will sound,
- the programme will be stopped,
- the washing will be cooled down and the "Cool air" light will come on.

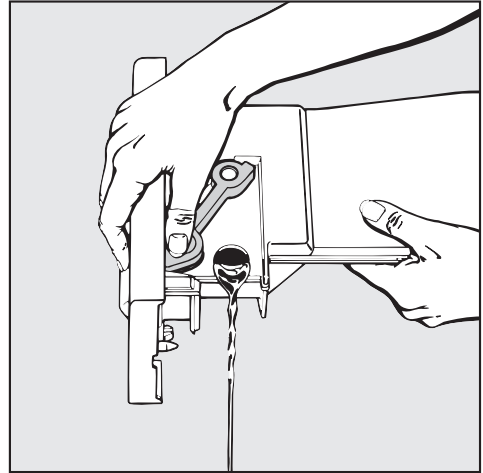

- Slide back the cap and pour the water away.
- Push the container back into the machine until it engages into place.

Condensed water should not be drunk. It could lead to health problems for humans and animals.

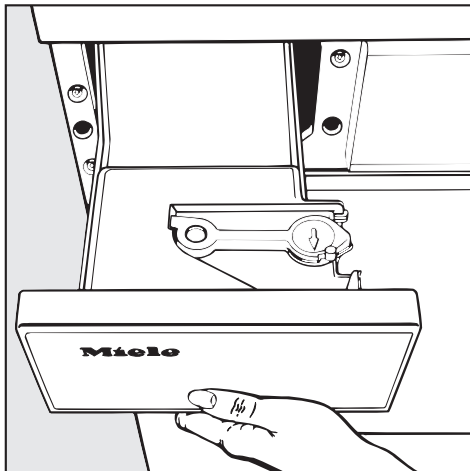

- Pull the container out of the machine, gripping it firmly with both hands.

Condensed water can be put to household use, eg used in a steam iron or humidifier.

Note:

- To ensure that no particles of fluff are left which could damage the appliance, pass the condensed water through a fine sieve or paper filter.

Cleaning and care

Cleaning the condenser unit

The machine must be disconnected from the electricity supply before cleaning.

Check the condenser unit at least twice a year and clean it if necessary. If the dryer is used frequently then clean the condenser unit after approx. 100 drying cycles.

- Turn the inner cover lock downwards to the vertical position.

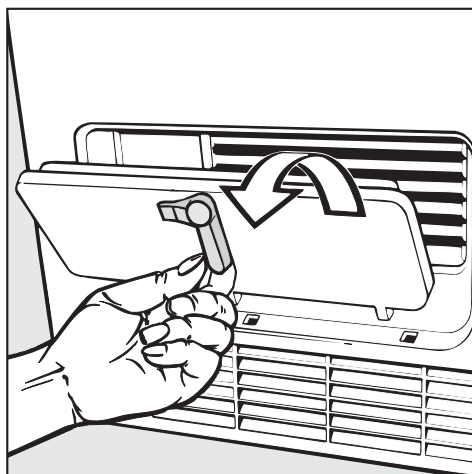

- Pull the cover off.

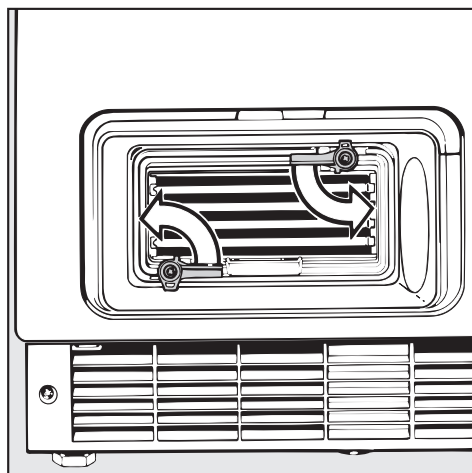

- Turn both the levers on the condenser unit to the vertical position.

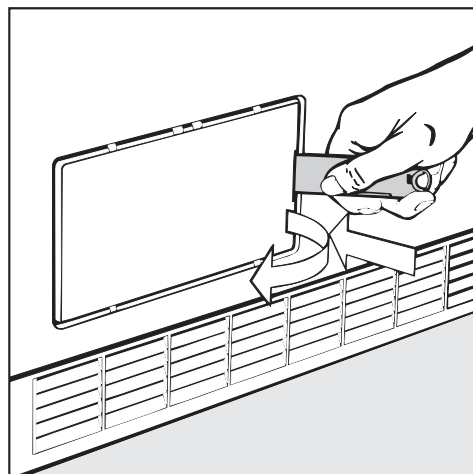

- Keep hold of the outer condenser unit cover while removing it, then place it to one side.

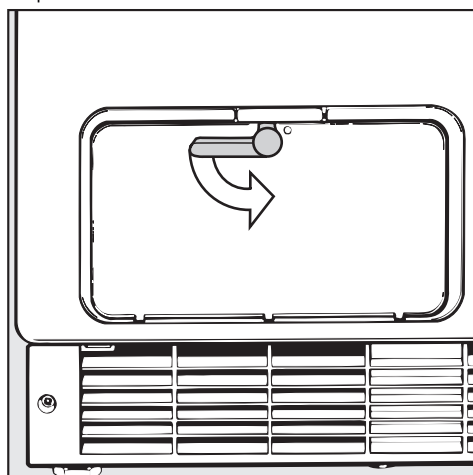

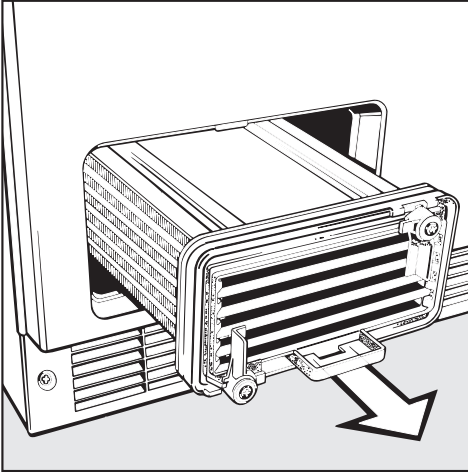

- Pull the condenser unit out.

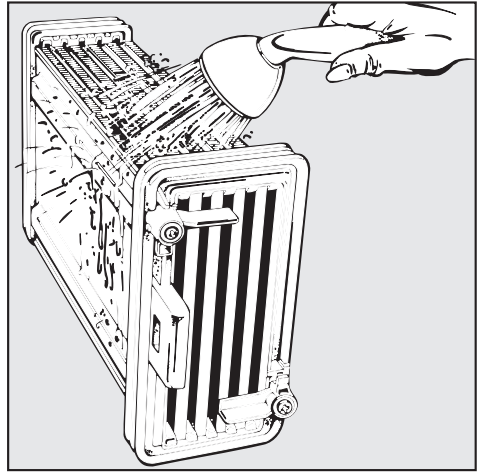

- Clean the two long sides of the unit.
- Stand the condenser unit lengthwise on a towel until it is quite dry.
- Replace the condenser unit correctly (see illustration above left).
- Return both levers on the condenser unit to the horizontal position. Pull forwards on the unit to check that it is firmly in place.
- Replace the inner cover and check that it is also firmly in place, otherwise water may leak from the machine.
- Reposition the outer cover and push back into place.

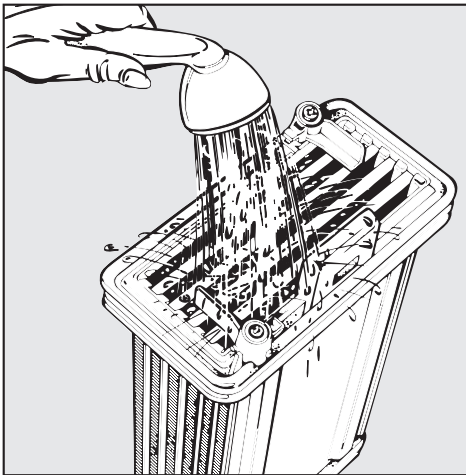

- Clean the condenser unit at both ends (front and back).

Wipe the rubber seals at both ends gently but thoroughly.

Problem solving guide

What to do if ...

Electrical appliances should only be repaired by qualified personnel. Incorrectly repaired machines may pose a considerable risk to the user.

What to do if ...	Cause ...	Remedy ...
... the tumble dryer fails to start when switched on	This may be due to an incorrect selection procedure sequence when switching on the machine.	Repeat the switch-on procedure (see section on "Drying correctly"). Also check the following: <ul style="list-style-type: none">– Is the machine plugged in at the mains switch?– Is the door closed properly?– Was the "I-On/0-Off" button pushed in?– Was the "START" button pushed in?– Has the fuse or circuit breaker tripped? If so, contact the Miele Service Department.
... items made of synthetic fibres are charged with static electricity after drying		Static charge can be reduced by adding a fabric conditioner for the final rinse in the washing machine.
... the laundry is not sufficiently dry	The load consists of different fabrics.	Select a more suitable drying programme next time.
... there is a build-up of fluff	Fluff is principally the result of friction when garments are being worn and washed. Machine drying hardly causes any fluff to form and, as has been established by research institutes, has no effect on the lifetime of fabric.	

Problem solving guide

What to do if . . .	Cause . . .	Remedy . . .
. . . the drying process goes on too long.	Ventilation to and from the dryer is insufficient (eg in a small room). This could cause the room temperature to rise sharply.	Open a door or window while the machine is in operation for increased air flow.
	The vent below the door is blocked.	Remove any objects that are blocking the vent below the door.
	The dryer cannot blow air out correctly.	<ul style="list-style-type: none"> — Clean the fluff filters in the door and the door opening. — Clean the condenser unit.
	The laundry was not sufficiently spun.	Spin the laundry in the washing machine at the highest possible spin speed.
. . . water droplets appear at the upper edge of the drum aperture.	A double filter system with dual insulation prevents fluff from being deposited in the condenser unit. This insulation can lead to a build-up of condensation.	Laundry being removed from the machine may come into contact with these water droplets, but they will dry off in a matter of minutes.
. . . water leaks from the machine after the condenser unit has been cleaned.	The condenser unit has not been correctly locked into place.	Ensure that the condenser unit and cover are firmly in position and lock into place again.
. . . the interior drum lighting does not come on.	It only lights up when the machine is switched on. The bulb may be defective.	Change the bulb. See instructions at the end of this section.
. . . you need to open the door during a power cut.		See instructions at the end of this section.

Problem solving guide

Check and indicator lights		
What to do if . . .	Cause . . .	Remedy . . .
. . . the “Drying” indicator light flashes.	The programme selector was moved after the beginning of the programme, but the programme continues to run correctly.	Turn the programme selector back to its original position and the light will go out.
. . . the “Anti-crease/Finish” light flashes.	There could be a fault.	<ul style="list-style-type: none"> – Switch the machine off and on again. – Select the programme and press “START”.
	Cold surrounding temperatures below freezing are affecting the machine (frozen condensed water).	– Install the appliance in a warmer room.
		If the light continues to flash there is a problem. Contact Miele Service Department.
. . . the “Empty out container” light comes on.	The condensed water container is full.	Empty the container. Check that the condensed water container is correctly positioned.
. . . the “Clean out airways” light comes on.	The fluff filters are blocked.	<ul style="list-style-type: none"> – Switch the dryer off with the “I-On/0-Off” button. – Clean the fluff filters after every use. (See “Cleaning and care”).
	The condenser unit may be blocked because it has not been cleaned for a long time.	<ul style="list-style-type: none"> – Switch the dryer off with the “I-On/0-Off” button. – Please note that the condenser unit must be cleaned regularly (see “Cleaning and care”).
. . . the programme is interrupted and the “Anti-crease/Finish” light comes on.	If there is no laundry in the drum when the programme is started, the electronics will register this and stop the programme. The programme will also be interrupted if the laundry placed in the drum is already dry.	

The interior drum lighting does not come on: changing the bulb

- Open the door.

Before changing the bulb, disconnect the machine from the mains power supply.

- Unscrew the plastic cover above the door inside the drum.

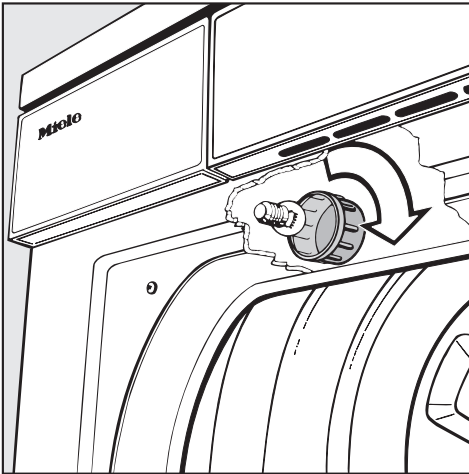

- Replace the bulb.

The light bulb must not exceed the maximum wattage quoted on the data plate and the light cover.

- Replace the plastic cover and screw back on.

The cover must be fixed securely otherwise moisture may seep in and cause a short circuit.

The temperature resistant bulb should only be ordered from your Miele dealer or the Miele Spare Parts Department.

Opening the door in the event of a power failure.

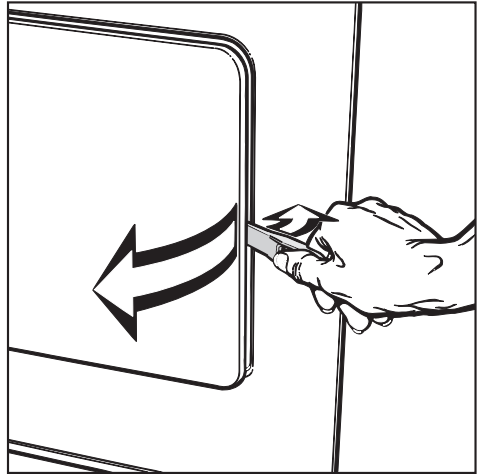

After sales service

Repairs

In the event of any fault which you cannot remedy yourself, please contact:

- your Miele dealer
- or
- your nearest Miele Service Department (see back cover for the address).

When contacting the Service Department, please quote the model and serial numbers of your appliance, both of which are shown on the data plate which is located beneath the drum opening on the right.

Future updates

The indicator or check light marked PC allows a service engineer to update your machine in future years.

When, for example, new programmes are developed or new fabrics are introduced, a service engineer will be able to modify existing programme cycles accordingly.

Miele will provide information when such possibilities become available.

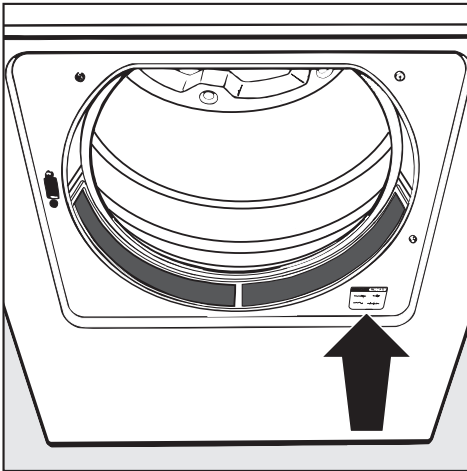

Please note that telephone calls may be monitored and recorded to improve our service.

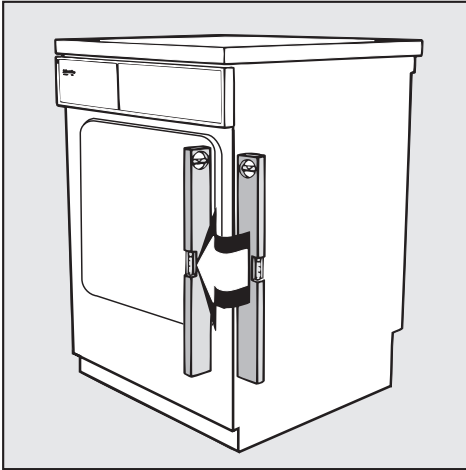

The ventilation slots beneath the door must on no account be blocked as this will prevent a sufficient intake of cold air.

Installation

Building under a continuous worktop/in a row of kitchen units

- A special conversion kit* is necessary.
- The machine lid is replaced by a coverplate which must be fitted by a suitable competent person to ensure electrical safety.
 - When installing under a worktop with a working height of 900/910 mm, a spacer kit* is necessary.

When built under, the running times may be longer.

The tumble dryer can also be combined with a Miele washing machine in a washer and dryer stack. For this purpose the appropriate stacking kit* to match your washing machine is required.

*These items are available from your Miele dealer.

(N.B. If you wish to push your machine under a worktop and there is space to do this without removing the lid, the conversion kit is not necessary. Otherwise the conversion kit is essential).

The machine must be perfectly level to ensure safe and proper operation. Minor differences do not, however, have an adverse effect on operation.

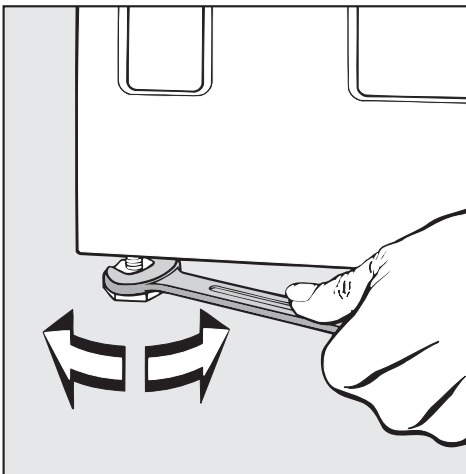

- The screw feet can be adjusted to compensate for any unevenness in the floor surface.

Installation

External condensed water outlet

The condensed water can be drained off directly if the machine is installed near a sink, drain outlet etc.

Maximum drain hose length: 3.00 metres
Maximum delivery head: 1.00 metre

Accessories supplied:

- 2 metre drain hose
- Hose clamp
- Adapter sleeve
- Hose clip

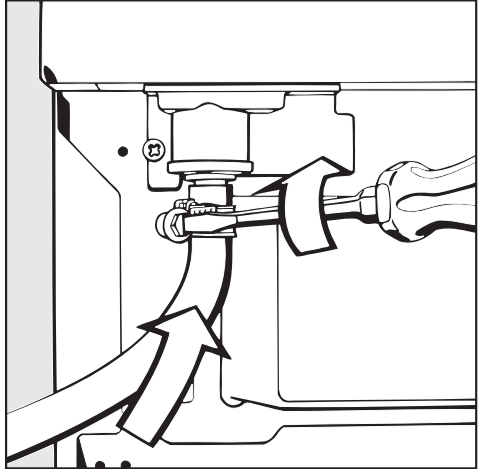

- Push the drain hose onto the drain outlet.
- Secure the hose firmly with the clip.
- Make sure that the hose is not kinked.

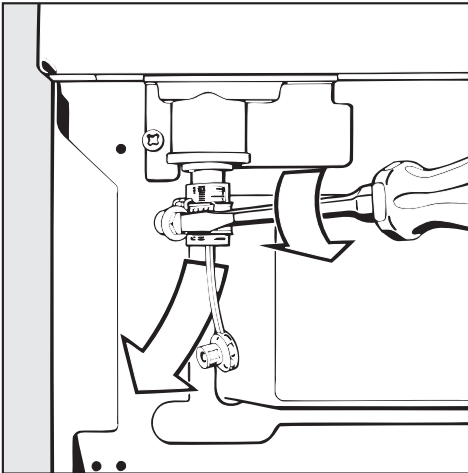

- Unscrew the hose clip from the drain outlet at the back of the machine.
- Remove the rubber plug.

The dryer is fitted with a non-return valve as standard to prevent water from flowing back into the machine.

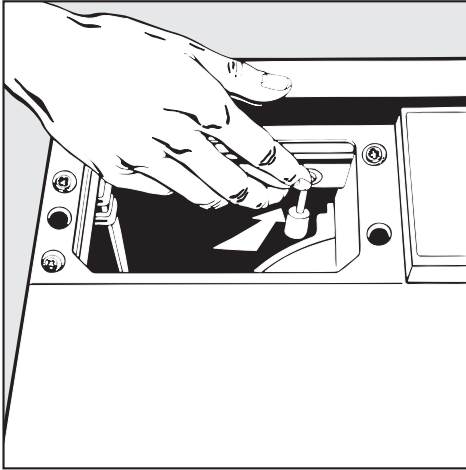

- Close the water inlet port to the condensed water container with the bottom part of the rubber plug. The plug must face towards the interior of the machine so that the condensed water container can be pushed in easily.

Connection to wash basin drain outlet (where appropriate)

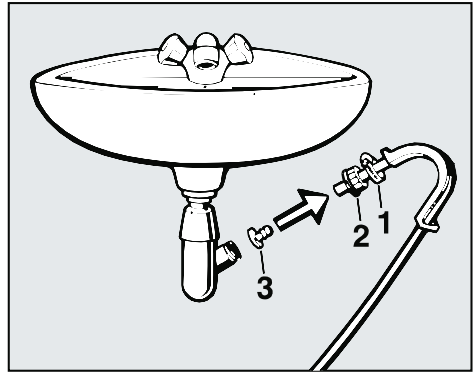

- Push the hose clip (1) and the knurled nut connector from the sink drain outlet (2) over the drain hose.
- Push the adapter sleeve (3) into the hose.
- Screw the drain hose to the drain outlet with the knurled nut connector.
- Tighten the hose clip up close to the nut.

Electrical connection

Electrical connection U.K.

All electrical work should be carried out only by a suitably competent person, in strict accordance with national and local safety regulations.

The appliance is supplied with a mains cable with moulded plug for connection to a 230-240V mains supply. The voltage, rated load and fuse rating are given on the data plate. Please ensure these match the household mains supply.

Connection should be made via a fused plug and suitable switched socket which is easily accessible after installation. For extra safety it is advisable to install a residual current device (RCD), with a trip current of 30 mA. Do not connect via an extension lead.

Important

The wires in the mains lead are coloured in accordance with the following code:

Green/yellow	= earth
Blue	= neutral
Brown	= live

Where it is necessary to change plugs, if the colours of the wires in the mains lead of this appliance do not correspond with the coloured markings identifying the terminals of your plug, proceed as follows:

The wire which is coloured green and yellow must be connected to the terminal in the plug which is marked with the letter E or by the earth symbol  or coloured green, or green and yellow.

The wire which is coloured blue must be connected to the terminal in the plug which is marked with the letter N or coloured black.

The wire which is coloured brown must be connected to the terminal in the plug which is marked with the letter L or coloured red.

WARNING: THIS APPLIANCE MUST BE EARTHED

Ensure power is not restored to the appliance while installation work is being carried out.

Non-rewireable plugs BS 1363

If this machine is fitted with a non-rewireable plug, the following information applies:

If the socket outlets are not suitable for the plug supplied with the product, it must be cut off and an appropriate plug fitted.

The plug cut from the flexible cord should be disposed of and on no account be inserted into any socket elsewhere in the house (electric shock hazard).

The fuse cover must be refitted when changing the fuse, and if the fuse cover is lost, the plug must not be used until a suitable replacement is obtained. The colour of the correct replacement cover is that of the coloured insert in the base of the plug, or the colour that is embossed in words on the base of the plug (as applicable to the design of plug fitted).

Replacement fuses should be ASTA approved to BS 1362 and have the correct rating. Replacement fuse covers may be purchased from your local electrical supplier or Service agent.

Consumption data

Programme	Capacity kg	Final spin speed (in a domestic washing machine) rpm	Electricity consumption kWh	Drying time incl. cooling down time Minutes	
				10 A ⁽²⁾	16 A ⁽²⁾
COTTONS					
Extra dry	5	1200	3.4	102	84
		1400	3.3	99	81
		1600	3.0	89	74
Normal +	5	1200	2.9	92	74
		1400	2.75	88	71
		1600	2.45	79	64
Normal ⁽¹⁾	5	800 (70 % residual moisture)	3.5	109	88
Normal	5	1200	2.75	88	71
		1400	2.6	85	68
		1600	2.35	77	62
Hand iron ∆∆ ⁽¹⁾	5	800 (70 % residual moisture)	2.85	91	74
Hand iron ∆∆	5	1200	2.1	67	57
		1400	1.95	66	54
		1600	1.65	57	47
Machine iron	5	1200	1.7	58	47
		1400	1.55	55	44
		1600	1.25	47	38
MINIMUM IRON					
Normal ⁽¹⁾	2.5	1000 (50 % residual moisture)	1.3	52	44
Hand iron	2.5	1000	1.15	48	40
Special care					
Woollens, Hand care	1	–	0.2	3	3
Smoothing	2.5	–	0.3	8	8

⁽¹⁾ Test performance in accordance with EN 61121/A11.

⁽²⁾ Drying times may vary slightly. For fuse rating see data plate.

All values obtained in accordance with standard test EN 61121/A11.

Different types of fabric, the load and residual moisture after spinning may affect the figures given.

Technical data

Height	850 mm (adjustable +10/-5 mm)
Width	595 mm
Depth	600 mm (incl. distance from wall)
Weight	52 kg
Drum volume	103 l
Maximum capacity	5 kg dry weight

Capacity of condensed water container	approx 4 l
Maximum delivery head	1 m
Maximum drain hose length	3 m

Voltage	} see data plate
Rated load	
Fuse rating	

Electricity consumption	see section "Consumption data"
Test certificates awarded	Radio/TV suppressed, VDE

**South Africa:**

Miele (Pty.) Ltd.
304 Tungsten Road, Strydom Park 2194
P.O.Box 1654, Randburg 2125
Tel. (011) 793-7452, Telefax (011) 793-7447
Internet: www.miele.co.za
E-mail: mieleza@iafrica.com

United Kingdom:

Miele Co. Ltd.
Fairacres, Marcham Road, Abingdon, Oxon, OX14 1TW
tel. Abingdon (01235) 554455 - fax (01235) 554477
Service Office, tel. Abingdon (01235) 554466
Internet: www.miele.co.uk

Ireland:

Miele Ireland Ltd.
Broomhill Road, Tallaght, Dublin 24
Tel: (01) 46 10 710, Fax: (01) 46 10 797
Email: info@miele.ie
Internet: <http://www.miele.ie>