

## Features:

- **Mixed Signal Oscilloscope:** Simultaneous sampling of 2 analog and 8 digital signals.
- **Advanced Trigger:** Normal / Single / Auto / Free, with edge or slope types, rising or falling; adjustable trigger level, and ability to view signals prior to the trigger.
- **Meter Mode:** VDC, VPP and Frequency readout.
- **XY Mode:** For plotting Lissajous figures, V/I curves or checking the phase difference between two waveforms.
- **Spectrum Analyzer** with different windowing options and selectable vertical log.
- **Protocol Sniffer:** SPI, I<sup>2</sup>C, UART
- **Arbitrary Waveform Generator** with frequency sweep.
- **Channel Math:** add, multiply, invert, and average.
- **Horizontal and Vertical Cursors** with automatic waveform measurements, and waveform references.
- Display options: Persistence, Different grid options.

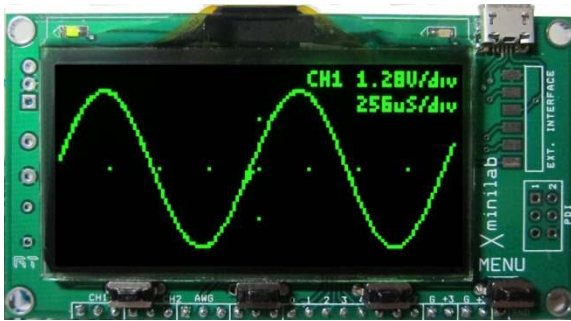

Figure 1: Xminilab Top View

## Description:

The Xminilab is a combination of three electronic instruments: a mixed signal oscilloscope, an arbitrary waveform generator, and a protocol sniffer; all housed in a small 1.75"x3.3" DIP module. The Xminilab can also be used as a development board for the AVR XMEGA microcontroller.

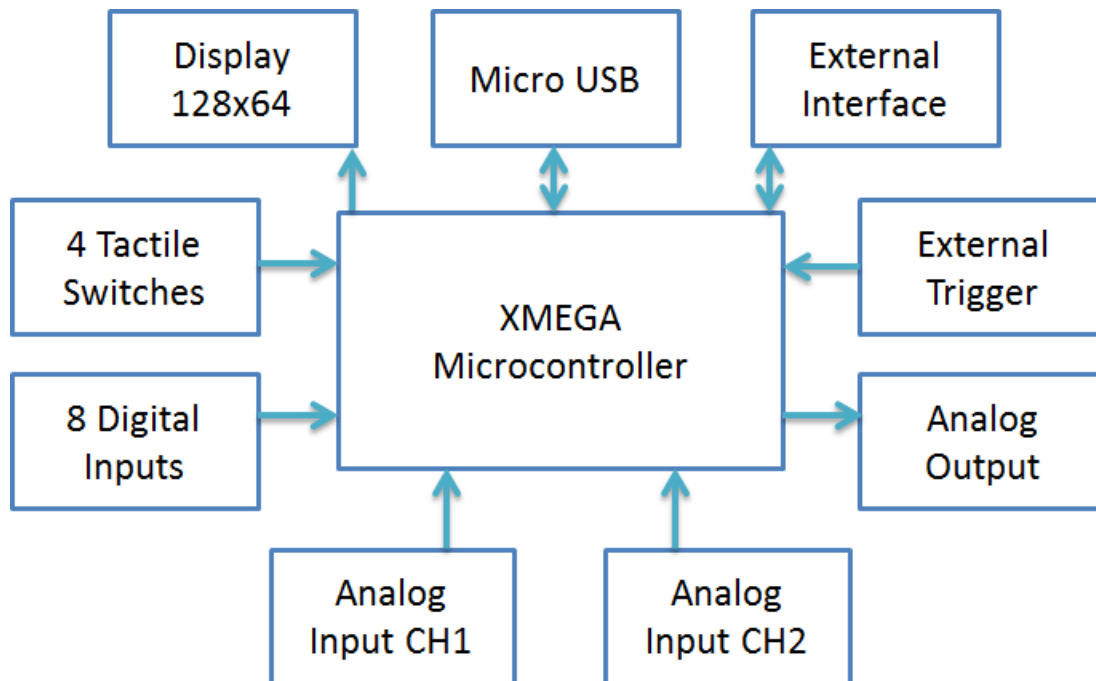

Figure 2: Xminilab Block Diagram



## About this manual

---

This manual targets both novice and advanced users, providing a full resource for everyone. However, for a full understanding of the operation of the Xminilab, the user should be familiar with the operation of a regular oscilloscope.

The features documented in this manual are for hardware version 2.1, and firmware version 1.41.

## Conventions

---

CH1: Analog Channel 1

CH2: Analog Channel 2

CHD: Logic Inputs

Fast Sampling: 10ms/div or faster

Slow Sampling: 20ms/div or slower



Helpful tip



Technical Detail

## Revision History

---

| Version | Date           | Notes                                             |
|---------|----------------|---------------------------------------------------|
| 1.0     | September 2011 | First revision                                    |
| 1.1     | October 2011   | Modified revision for the Xminilab                |
| 1.2     | December 2011  | Firmware upgrade                                  |
| 1.3     | January 2012   | AWG maximum frequency 125 kHz                     |
| 1.4     | January 2012   | Added vertical sensitivity to specifications      |
| 1.5     | January 2012   | Changed seconds units from S to s                 |
| 1.6     | February 2012  | Corrected discrepancies in the interface protocol |

## TABLE OF CONTENTS

|                                           |           |
|-------------------------------------------|-----------|
| <b>1. General Overview.....</b>           | <b>7</b>  |
| 1.1 Pin Description.....                  | 7         |
| 1.2 Absolute Maximum Ratings .....        | 7         |
| 1.3 Specifications.....                   | 8         |
| 1.4 Factory Setup.....                    | 9         |
| 1.5 Quick Start Guide .....               | 9         |
| 1.6 User Interface .....                  | 10        |
| 1.7 Saving the settings.....              | 10        |
| <b>2. Mixed Signal Oscilloscope .....</b> | <b>11</b> |
| 2.1 Horizontal Settings.....              | 11        |
| 2.1.1 Time Base.....                      | 11        |
| 2.1.2 Technical Details .....             | 11        |
| 2.1.3 Horizontal Position .....           | 11        |
| 2.1.4 Auto Setup .....                    | 11        |
| 2.2 Vertical Settings .....               | 12        |
| 2.2.1 Disable Channel.....                | 12        |
| 2.2.2 Channel Gain .....                  | 12        |
| 2.2.3 Channel Position.....               | 12        |
| 2.2.4 Channel Invert .....                | 12        |
| 2.2.5 Channel Math.....                   | 12        |
| 2.3 Trigger Settings .....                | 13        |
| 2.3.1 Trigger Types.....                  | 13        |
| 2.3.2 Trigger Modes .....                 | 13        |
| 2.3.3 Post Trigger .....                  | 14        |
| 2.3.4 Trigger Source .....                | 14        |
| 2.4 Device Modes.....                     | 15        |
| 2.4.1 Meter Mode .....                    | 15        |



---

|           |                                                  |           |
|-----------|--------------------------------------------------|-----------|
| 2.4.2     | XY Mode .....                                    | 15        |
| 2.4.3     | Oscilloscope Mode.....                           | 15        |
| 2.5       | Spectrum Analyzer .....                          | 16        |
| 2.5.1     | Logarithm display .....                          | 16        |
| 2.5.2     | FFT Windows .....                                | 16        |
| 2.6       | Cursors .....                                    | 17        |
| 2.6.1     | Vertical Cursors.....                            | 17        |
| 2.6.2     | Horizontal Cursors .....                         | 17        |
| 2.6.3     | Automatic Cursors.....                           | 17        |
| 2.6.4     | Lock Cursors .....                               | 17        |
| 2.6.5     | Reference Waveform.....                          | 17        |
| 2.7       | Display Settings .....                           | 18        |
| 2.7.1     | Persistent Display .....                         | 18        |
| 2.7.2     | Line / Pixel Display .....                       | 18        |
| 2.7.3     | Show scope settings .....                        | 18        |
| 2.7.4     | Grid Type .....                                  | 18        |
| 2.7.5     | Flip Display.....                                | 18        |
| 2.7.6     | Invert Display.....                              | 18        |
| <b>3.</b> | <b>Logic Analyzer and Protocol Sniffer .....</b> | <b>19</b> |



|           |                                           |                                     |
|-----------|-------------------------------------------|-------------------------------------|
| 3.1       | Input Selection .....                     | 19                                  |
| 3.2       | Channel Position .....                    | 19                                  |
| 3.3       | Invert Channel .....                      | 19                                  |
| 3.4       | Thick Logic '0' .....                     | 19                                  |
| 3.5       | Parallel Decoding .....                   | 20                                  |
| 3.6       | Serial Decoding .....                     | 20                                  |
| 3.7       | Protocol Sniffer .....                    | 20                                  |
| 3.8       | Sniffers Modes .....                      | 20                                  |
| 3.9       | I2C Sniffer .....                         | 21                                  |
| 3.10      | UART Sniffer .....                        | 21                                  |
| 3.11      | SPI Sniffer .....                         | 21                                  |
| <b>4.</b> | <b>Arbitrary Waveform Generator .....</b> | <b>22</b>                           |
| 4.1       | Predefined Waveforms.....                 | 22                                  |
| 4.2       | Frequency Sweep .....                     | 22                                  |
| 4.3       | Technical Details.....                    | 23                                  |
| <b>5.</b> | <b>PC Interface.....</b>                  | <b>23</b>                           |
| <b>6.</b> | <b>Interface Protocol .....</b>           | <b>24</b>                           |
| 6.1       | UART settings.....                        | 24                                  |
| 6.2       | Control data.....                         | 24                                  |
| 6.2.1     | CH1 and CH2 settings (3 bytes) .....      | 24                                  |
| 6.2.2     | CHD settings (5 bytes).....               | 24                                  |
| 6.2.3     | General settings (10 bytes) .....         | 25                                  |
| 6.2.4     | AWG settings (9 bytes) .....              | <b>Error! Bookmark not defined.</b> |
| 6.3       | Command Set.....                          | <b>Error! Bookmark not defined.</b> |
| <b>7.</b> | <b>BMP Screen Capture.....</b>            | <b>28</b>                           |



---

|                                                         |           |
|---------------------------------------------------------|-----------|
| 7.1 To send a BMP screen capture to a PC:.....          | 28        |
| 7.2 To send a BMP screen capture to Linux:.....         | 29        |
| <b>8. Firmware Updating.....</b>                        | <b>30</b> |
| 8.1 Firmware upgrade using an external programmer ..... | 30        |
| 8.1.1 Tools required.....                               | 30        |
| 8.1.2 Instructions to install the tools .....           | 30        |
| 8.1.3 Instructions to update the firmware .....         | 30        |
| 8.2 Firmware upgrade using the bootloader .....         | 31        |
| 8.2.1 Tools required.....                               | 31        |
| 8.2.2 Activating the bootloader.....                    | 31        |
| 8.2.1 FLIP application instructions.....                | 31        |
| <b>9. Frequently Asked Questions .....</b>              | <b>32</b> |
| <b>10. Troubleshooting.....</b>                         | <b>33</b> |
| <b>11. Xminilab Design .....</b>                        | <b>34</b> |
| 11.1 System Architecture .....                          | 34        |
| 11.2 Schematics .....                                   | 35        |



## 1. General Overview

### 1.1 Pin Description

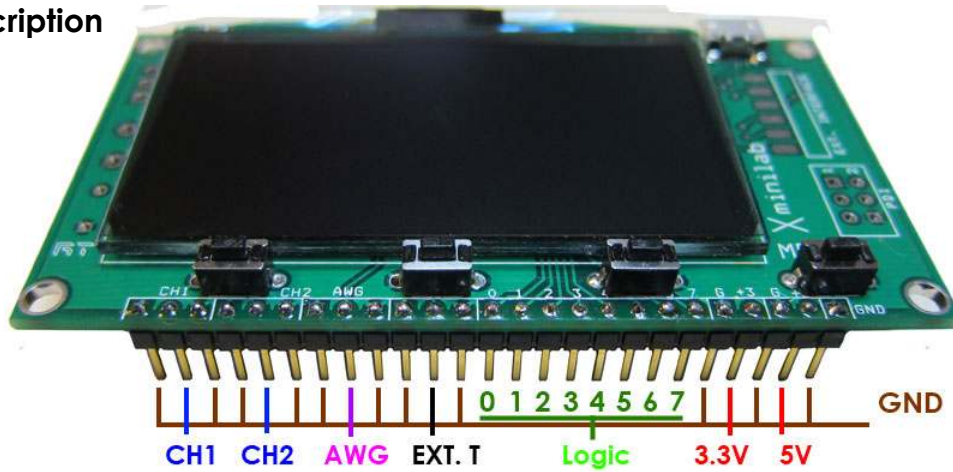

Figure 3: Back Signals

| Name    | Description                  | Comment                                |
|---------|------------------------------|----------------------------------------|
| CH1     | Analog Channel 1             | Input range: -14V to +20V              |
| CH2     | Analog Channel 2             | Input range: -14V to +20V              |
| AWG     | Arbitrary Waveform Generator | Output range: +/- 2V                   |
| EXT. T  | External Trigger             | Digital input, max 5.5V                |
| Logic 0 | Digital Channel 0            | I2C Sniffer signal: SDA                |
| Logic 1 | Digital Channel 1            | I2C Sniffer signal: SCL                |
| Logic 2 | Digital Channel 2            | UART Sniffer signal: RX                |
| Logic 3 | Digital Channel 3            | UART Sniffer signal: TX                |
| Logic 4 | Digital Channel 4            | SPI Sniffer signal: /SS                |
| Logic 5 | Digital Channel 5            | SPI Sniffer signal: MOSI               |
| Logic 6 | Digital Channel 6            | SPI Sniffer signal: MISO               |
| Logic 7 | Digital Channel 7            | SPI Sniffer signal: SCK                |
| +3.3V   | +3.3V Output voltage         | 200mA max output                       |
| +5V     | +5V Input voltage            | Do not apply +5V if using the USB port |
| GND     | Ground                       | It is recommended use all ground pins  |

Table 1: Pin description

### 1.2 Absolute Maximum Ratings

| Parameter             | Minimum | Maximum | Unit |
|-----------------------|---------|---------|------|
| Supply Voltage (+5V)  | -0.5    | 5.5     | V    |
| Analog Inputs         | -30     | 30      | V    |
| Digital Inputs        | -0.5    | 3.8     | V    |
| External Trigger      | -2.2    | 5.5     | V    |
| Operating Temperature | -40     | 70      | °C   |
| Storage Temperature   | -40     | 80      | °C   |

Table 2: Absolute Maximum Ratings



## 1.3 Specifications

### General Specifications:

- ATXMEGA32A4U 36KB Flash, 4KB SRAM, 1KB EEPROM.
- Graphic OLED display 2.42", 128x64 pixels. 40,000 hours minimum life time (to 50% original brightness).
- Module size: 3.3" x 1.75".
- PDI interface.
- 4 tactile switches.
- Micro USB

### Logic Analyzer specifications:

- 8 Digital Inputs.
- Maximum sampling rate: 2Msps.
- Protocol Sniffer: UART, I2C, SPI.
- Internal pull up or pull down.
- Buffer size: 256.
- Voltage level: 3.3V.

### Oscilloscope specifications:

- 2 Analog Inputs.
- Maximum Sampling rate: 2Msps.
- Analog Bandwidth: 200kHz.
- Resolution: 8bits.
- Input Impedance: 1M $\Omega$ .
- Buffer size per channel: 256.
- Input Voltage Range: -14V to +20V.
- Vertical sensitivity: 80mV/div to 5.12V/div

### AWG specifications:

- 1 Analog Output.
- Maximum conversion rate: 1Msps.
- Analog Bandwidth: 44.1kHz.
- Resolution: 8bits.
- Output current > +/- 7mA.
- Buffer size: 256.
- Output Voltage: +/- 2V.

**Weight:** 25 grams.





## Dimensions:

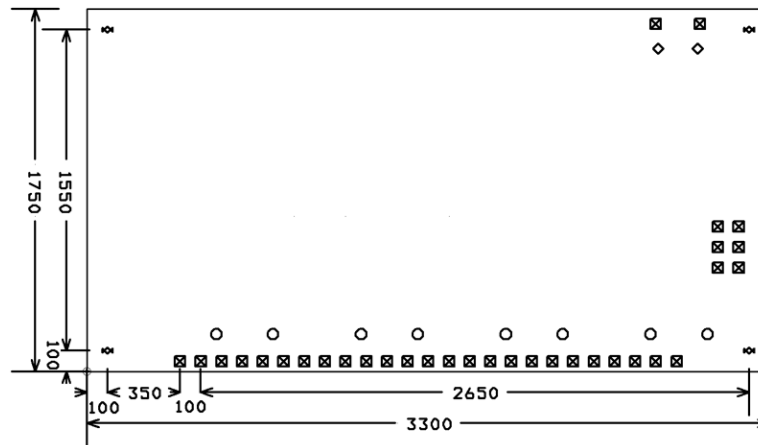

Figure 4: Xminilab dimensions

## 1.4 Factory Setup

The device can enter factory options if the MENU key is pressed during power up. The following options are available:

- 1) **Offset calibration:** The unit is calibrated before being shipped, but calibration is required again if the firmware is updated.
- 2) **Sleep timeout:** Sets the time to shut down the display and put the microcontroller to sleep after the last key press. Shutting down the OLED extends its life. The current consumption is also reduced.
- 3) **Restore defaults:** Select this function to restore to the default the settings. There are many settings on the device, if you are not familiar with them, this function is useful to set the device to a known state.

## 1.5 Quick Start Guide

- Take the Xminilab out of the packaging. Included is an optional 2x3 pin header, used for programming the microcontroller via the PDI interface. There is a protective film on the display which can be removed.
- Place the Xminilab on a breadboard and apply power. The Xminilab can be powered with either the USB or with an external power supply, by applying +5V on the corresponding pin. Double check your connections because the Xminilab WILL get damaged if applying power on the wrong pin.
- Connect the AWG pin to CH1.
- Press the K2 and K3 keys simultaneously (auto setup). The screen should look like figure 6.

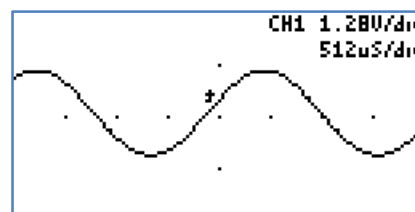

Figure 5: Quick start



## 1.6 User Interface

The K4 button is the MENU button, used to navigate thru all the menus. The K1 - K3 buttons action depend on the current menu. The green arrows represent the flow when pressing the MENU button. When the MENU button is pressed on the last menu, the Xminilab settings are saved and the menu goes back to the default. Figure 7 shows the main menus in blue, and some important submenus in yellow. Further ramifications are shown on the respective chapters.

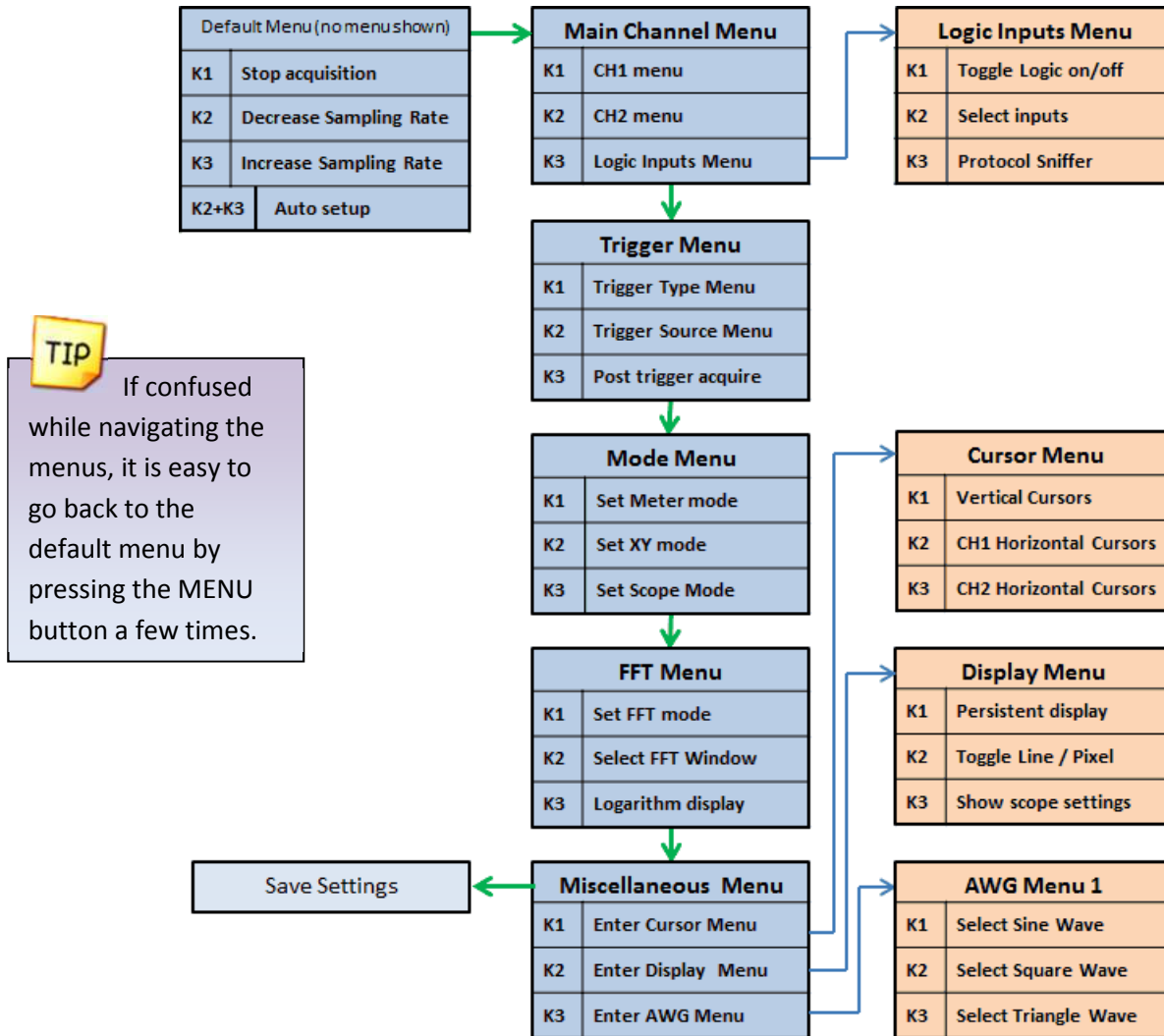

Figure 6: Main Menus

## 1.7 Saving the settings

All the settings are stored to non-volatile memory only when exiting from the last menu (Miscellaneous Menu). This method is used to reduce the number of writes to the microcontroller's EEPROM.



## 2. Mixed Signal Oscilloscope



The Xminilab is a mixed signal oscilloscope; it has 2 analog channels and 8 digital channels. This chapter will focus on the analog signals. More information about the digital channels is presented on chapter 4.

### 2.1 Horizontal Settings

The horizontal settings are controlled on the default menu. The menu is shown on figure 7.

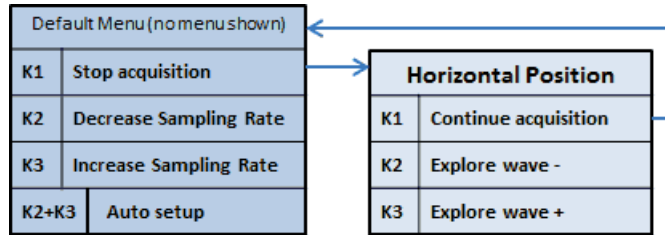

Figure 7: Horizontal Menu

#### 2.1.1 Time Base

The time base can be varied from 8µs/div to 50s/div. Table 1 shows all the possible time bases. One time division consists of 16 pixels. Example: 8µs / division = 8µs / 16 pixels ==> 500ns / pixel.

|                      |      |     |     |     |     |      |      |      |    |    |    |     |
|----------------------|------|-----|-----|-----|-----|------|------|------|----|----|----|-----|
| Time Base<br>s / div | Fast | *8µ | 16µ | 32µ | 64µ | 128µ | 256µ | 512µ | 1m | 2m | 5m | 10m |
|                      | Slow | 20m | 50m | 0.1 | 0.2 | 0.5  | 1    | 2    | 5  | 10 | 20 | 50  |

Table 3: Time divisions

\*At 8µs/div, CH2 is not displayed.

#### 2.1.2 Technical Details



There are two distinct sampling methods: Fast Sampling and Slow Sampling.

- **Fast Sampling** (10ms/div or faster): All samples are acquired to fill the buffer, and then they are displayed on the screen. Only 128 samples of the 256 are visible at a single time.
- **Slow Sampling** (20ms/div or slower): Single samples are acquired and simultaneously displayed on the display. All 256 samples are visible on the display (each vertical line will have at least two samples).

#### 2.1.3 Horizontal Position

The horizontal position can be varied on the Fast Sampling time bases. There are 256 samples for each channel, but only 128 can be displayed on the screen. When the acquisition is stopped, the full sample buffer can be explored with the K2 and K3 buttons.

#### 2.1.4 Auto Setup

The Auto Setup feature will find the optimum gain and time base for the signals being applied on CH1 and CH2.

## 2.2 Vertical Settings

The analog channel controls are discussed in this section. Figure 9 shows the Vertical menu flow.

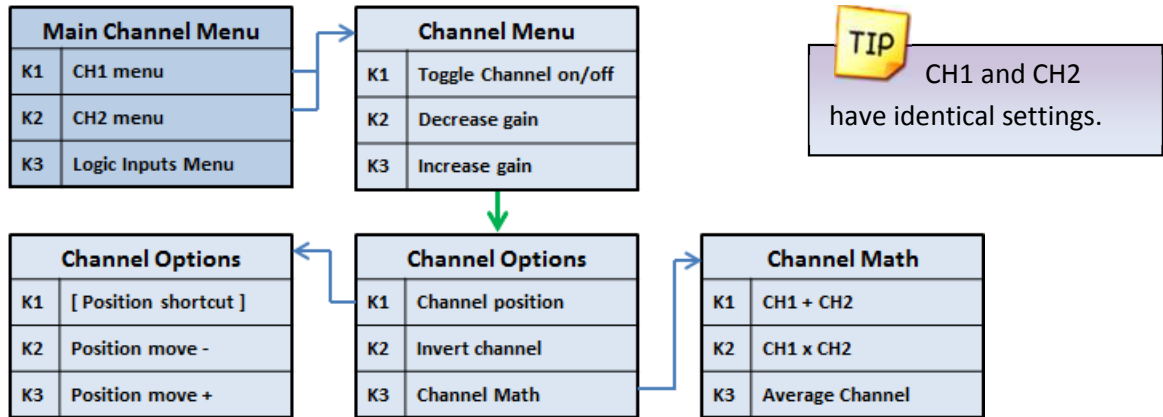

Figure 8: Vertical menus

### 2.2.1 Disable Channel

Any channel can be disabled; this is useful to reduce clutter on the display.

### 2.2.2 Channel Gain

Table 4 shows the possible gain settings for the analog channels. One gain division consists of 16 pixels.

|                         |     |      |      |      |      |      |      |
|-------------------------|-----|------|------|------|------|------|------|
| Gain (Volts / Division) | 80m | 0.16 | 0.32 | 0.64 | 1.28 | 2.56 | 5.12 |
|-------------------------|-----|------|------|------|------|------|------|

Table 4: Gain Settings

The current gain settings for the analog channels are shown in the top right part of the display (If the SHOW setting of the display is enabled).

### 2.2.3 Channel Position

The position of the waveform can be moved up or down in the Channel Position menu.

### 2.2.4 Channel Invert

The channel can be inverted. The displayed waveform and channel calculations will be affected.

### 2.2.5 Channel Math

- Add: The channel trace will be replaced with CH1+CH2.
- Multiply: The channel trace will be replaced with CH1xCH2
- Average: The channel samples will be averaged.

**TIP** To display CH1-CH2, first invert CH2 and then select the ADD function.

Channel Math Examples:

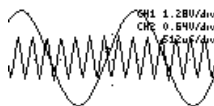

Figure 11: Two signals



Figure 10: CH1+CH2

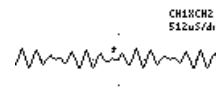

Figure 9: CH1xCH2

## 2.3 Trigger Settings

The Xminilab has an advance triggering system; it has most of the trigger controls of a professional oscilloscope. Figure 13 shows all the trigger menus.

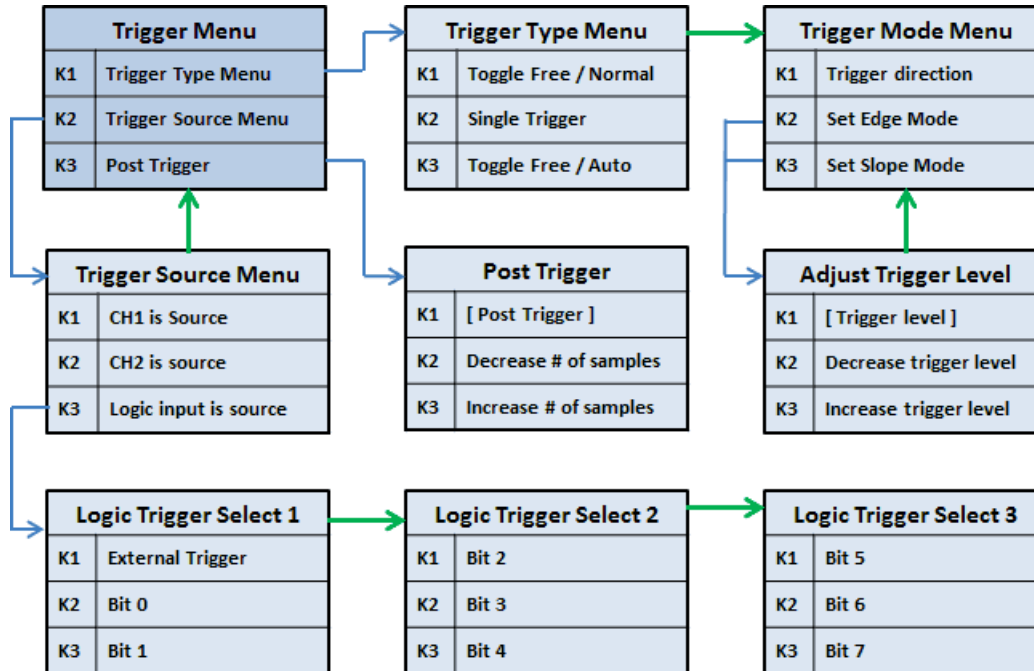

Figure 12: Trigger menus

### 2.3.1 Trigger Types

There are four different trigger types, which determine when to display the trace on the screen:

- **Normal:** Trace only when the trigger event occurs.
- **Single:** One trace is displayed when the trigger event occurs.
- **Auto:** Trace when the trigger event occurs, or after a timeout.
- **Free:** Trace continuously ignoring the trigger.

### 2.3.2 Trigger Modes

Two triggering modes are available. After selecting the trigger mode, the next menu will allow setting the specific trigger value.

- **Edge:** The trigger occurs when the signal crosses a defined level. This is the most common trigger mode. The trigger mark is represented on the display as a rising or falling arrow.
- **Slope:** The trigger occurs when the difference between two consecutive samples is greater than a predefined value. This is useful for detecting spikes or for detecting high frequency signals. The trigger mark is represented on the screen as two small lines, with a size proportional to the trigger value.

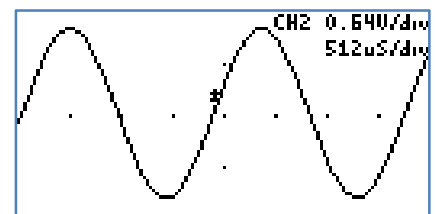

Figure 13: Edge Trigger

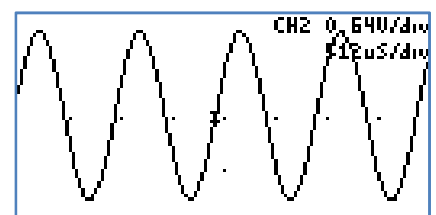
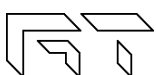

Figure 14: Slope trigger



### 2.3.3 Post Trigger

The oscilloscope is continuously acquiring samples in a circular buffer. Once the trigger event occurs, the oscilloscope will acquire more samples, specified by the Post Trigger value. The ability to show samples before or after the trigger occurs is one of the most powerful features of a digital sampling oscilloscope.

Depending on the post trigger settings, different parts of a signal can be displayed. Consider the signal on figure 16:



Figure 15: Sample signal

Even though the buffer sample is relatively small, any section of the shown figure can be analyzed by varying the post trigger. Examples:

- Post trigger = 0 (don't acquire more signals after the trigger).  
Only the signals that occurred before the trigger event are shown.

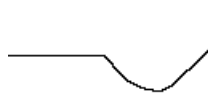

Figure 16: Post trigger value equal zero

- Post trigger = 50% of the sample buffer (default setting).  
Half of the buffer contains samples before the trigger, and half contains the samples after the trigger.

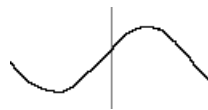

Figure 17: Post trigger = 50% of sample buffer

- Post trigger = 100% of the sample buffer  
Only signals immediately after the trigger event are shown.



Figure 18: Post trigger = 100% of buffer

The actual post trigger value can vary between 0 and 32768 samples, so you can explore the signal after a very long time after the trigger event has occurred, but with a high post trigger value, the refresh rate of the scope will be reduced.

### 2.3.4 Trigger Source

Any analog or digital channel can be the trigger source. If selecting a digital channel, the slope trigger mode is not applicable. The external trigger input is an additional digital trigger source, but tolerates voltages up to 5.5V.

## 2.4 Device Modes

There are different device modes that can be selected; the menus shown on figure 20 allow selecting the Meter Mode, the XY Mode or the Oscilloscope Mode. Other device modes are the Spectrum Analyzer and the Protocol Sniffer, which are discussed in their respective chapters.

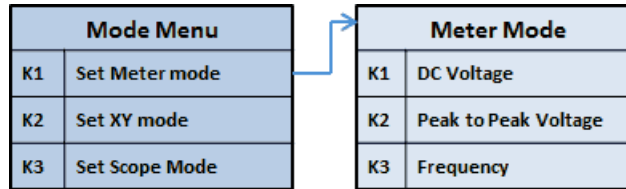

Figure 19: Device mode menus

### 2.4.1 Meter Mode

The Xminilab can function as a dual digital voltmeter. The font used is bigger in meter mode to facilitate reading. The available measurements in meter mode are: Average Voltage (DC), Peak to Peak Voltage, and Frequency.

The Frequency measurement is performed with an FFT, so the measurement frequencies will have gaps, depending on the range.

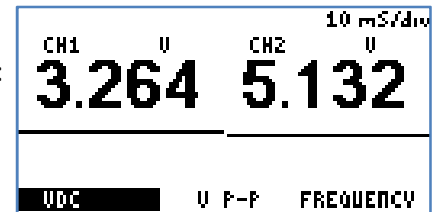

Figure 20: Meter Mode

### 2.4.2 XY Mode

The XY mode changes the display from volts vs. time display to volts vs. volts. You can use XY mode to compare frequency and phase relationships between two signals. XY mode can also be used with transducers to display strain versus displacement, flow versus pressure, volts versus current, or voltage versus frequency

Lissajous figures can also be plotted using the XY Mode.

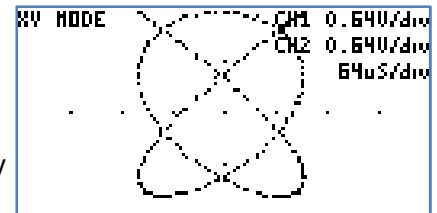

Figure 21: XY Mode

### 2.4.3 Oscilloscope Mode

This is the default mode of the Xminilab. The 2 analog and 8 digital channels are sampled simultaneously. Any of these 10 channels can be shown on the display. Figure 23 shows the oscilloscope mode and the various sections of the display are detailed.

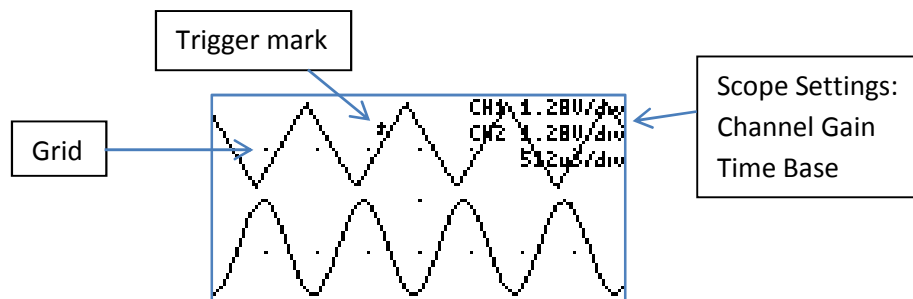

Figure 22: Oscilloscope Mode

### 2.5 Spectrum Analyzer

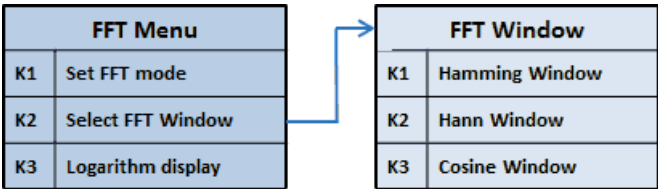

Figure 23: Spectrum Analyzer menus

**TIP** If only interested in one channel, turn off the other channel to maximize the vertical display.

The spectrum analyzer is done by calculating the Fast Fourier Transform (FFT) of the selected analog channels, or the math functions if enabled. Figure 24 shows the FFT menus. When Spectrum Analyzer is enabled, the display of the FFT spectrum is plotted as frequency vs. magnitude. The horizontal axis represents the frequency (Hertz), and the vertical axis represents the magnitude. Figure 25 shows the Xminilab in Spectrum Analyzer Mode.

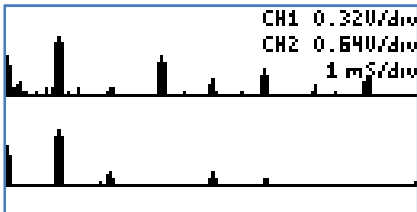

Figure 24: Spectrum Analyzer Mode

#### 2.5.1 Logarithm display

The log is useful when analyzing low level components on the signal. When analyzing audio, it is also very useful as it maps more directly to how humans perceive sound. The actual function performed is:  $y = 16 * \log_2(x)$ .

Example:



Figure 27: Triangle Wave

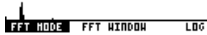

Figure 25: FFT without Log



Figure 26: FFT with Log

#### 2.5.2 FFT Windows

To reduce the spectral leakage, an FFT window function must be applied. Three FFT window types are available:

- **Hamming:**  $0.53836 - 0.46164 * \cos\left(2 * \pi * \frac{n}{FFT_N-1}\right)$

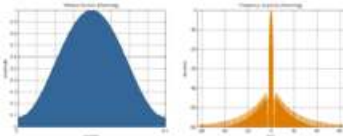

Figure 28: Hamming Window and sine frequency response

- **Hann:**  $0.5 * \left(1 - \cos\left(2 * \pi * \frac{n}{FFT_N-1}\right)\right)$

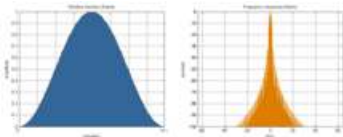

Figure 29: Hann Window and sine frequency response

- **Cosine:**  $SIN\left(\pi * \frac{n}{FFT_N-1}\right)$

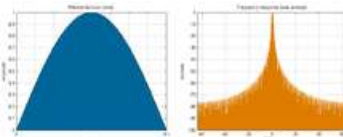

Figure 30: Cosine Window and sine frequency response





## 2.6 Cursors

You can measure waveform data using cursors. Cursors are horizontal and vertical markers that indicate X-axis values (usually time) and Y-axis values (usually voltage) on a selected waveform source. The position of the cursors can be moved on the respective menu. Figure 32 shows the cursor menus.

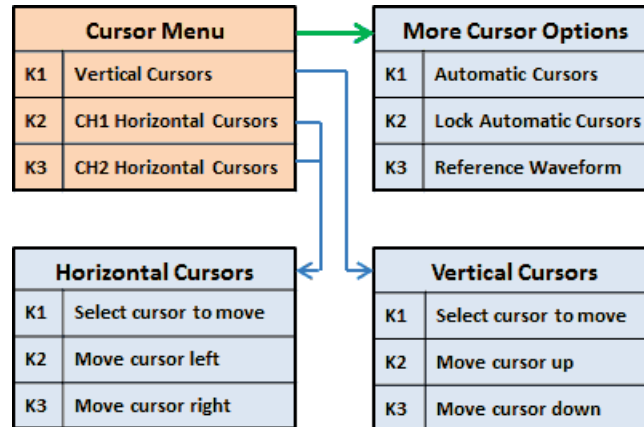

Figure 31: Cursor menus

### 2.6.1 Vertical Cursors

Time interval measurements are made with a pair of time markers. The oscilloscope automatically calculates the time difference between the two markers and displays the difference as a delta time. Additionally, the oscilloscope calculates the inverse of the delta time, which is the frequency of the selected period.

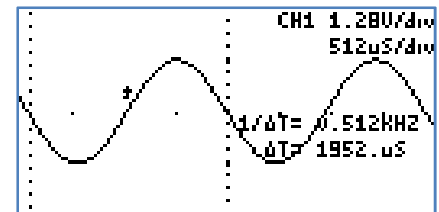

Figure 32: Vertical Cursors

### 2.6.2 Horizontal Cursors

Voltage measurements are made with a pair of voltage markers to determine 1 or 2 specific voltage points on a waveform. The oscilloscope automatically calculates the voltage difference between the two markers and displays the difference as a delta voltage value.

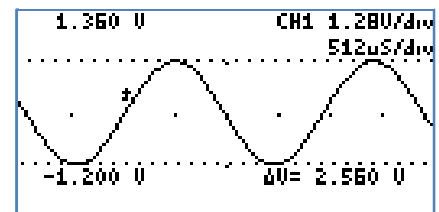

Figure 33: Horizontal Cursors

### 2.6.3 Automatic Cursors

The device will try to automatically measure the waveform.

- **Vertical Cursors:** The device will try to a full or half cycle of the selected waveform. If both CH1 and CH2 are enabled, the channel with the most amplitude will be used.
- **Horizontal Cursor:** The selected horizontal cursor will be set with the maximum and minimum points of the waveform.

### 2.6.4 Lock Cursors

Same as the automatic cursors, but it is performed continuously.

### 2.6.5 Reference Waveform

A snapshot is taken of the analog waveforms to be used as reference waveforms. The reference waveforms are stored in non-volatile memory.

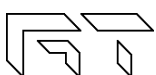

## 2.7 Display Settings

These menus control various characteristics of the display. Figure 35 show the display menus.

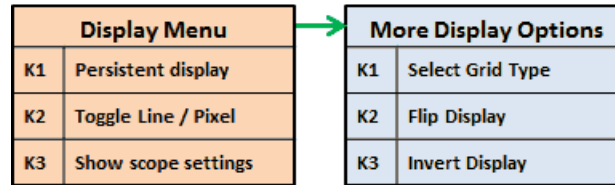

Figure 34: Display menus

### 2.7.1 Persistent Display

When the persistent display is enabled, the waveform traces are not erased. The persistent display is useful as a simple data logger or to catch glitches in the waveform. The persistent mode can also be used to make frequency plots in combination with the AWG frequency sweep.

### 2.7.2 Line / Pixel Display

This menu item selects the drawing method.

- **Line:** A line is drawn from one sample to the next.
- **Pixel:** A single pixel represents a sample. The pixel display is useful at slow sampling rates or when used in combination with the persistent mode. Figure 36 shows the pixel display.

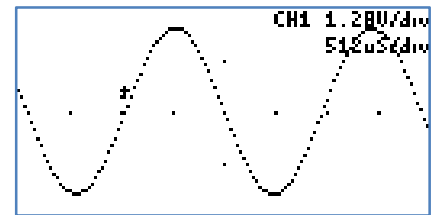

Figure 35: Pixel Display

### 2.7.3 Show scope settings

Toggles the display of the scope settings (Channel gain and time base).

### 2.7.4 Grid Type

There are 4 different grid types:

- **No grid.**
- **Dots for each division:** Vertical dots represent the scale divisions. Horizontal dots represent the time base setting and the ground level of each channel.
- **Vertical grid line follow trigger:** Vertical dots represent the position of the trigger, the location of the vertical dots follow the trigger position. Horizontal dots represent the time base setting and the ground level of each channel.
- **Dot graticule:** The screen is filled with dots that represent the vertical and horizontal divisions.

### 2.7.5 Flip Display

The display orientation is flipped. This is useful when mounting the Xminilab on a panel, and the display's orientations is backwards.

### 2.7.6 Invert Display

When enabled, the display's pixels are inverted (the display will have a white background).



## 3. Logic Analyzer and Protocol Sniffer



The Xminilab has an 8 bit logic analyzer and can do sniffing on standard protocols: I2C, UART and SPI. The logic inputs are 3.3V level (the logic inputs are not 5V tolerant!). If you need to connect 5V signals to the logic analyzer, you could: Add a 3K resistor in series with the signal, or, use a 5V to 3.3V level converter chip. Figure 37 shows the logic menus.

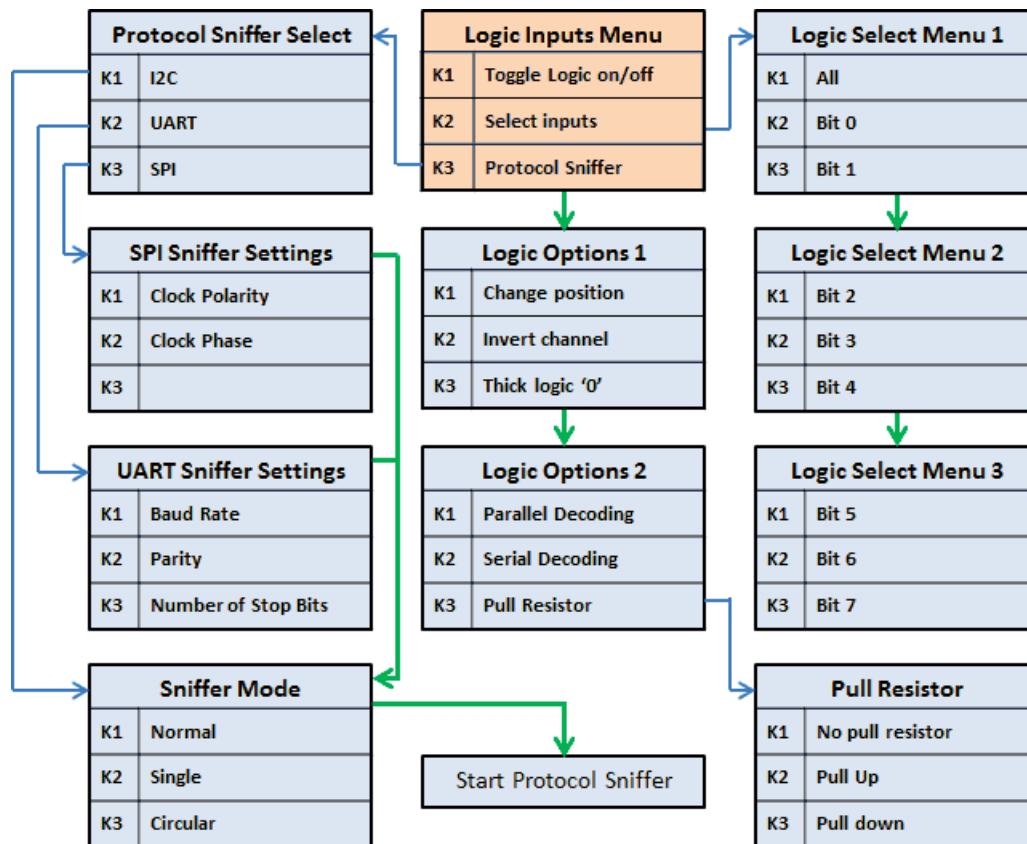

Figure 36: Logic Analyzer Menus

### 3.1 Input Selection

A subset of the 8 digital signals can be selected. Any digital signal can be enabled or disabled.

### 3.2 Channel Position

The selected digital channels can be moved up or down. Only applicable if less than 8 digital signals are selected.

### 3.3 Invert Channel

All digital channels are inverted. This setting also affects the protocol sniffer!.

### 3.4 Thick Logic '0'

A thick line is drawn when the signal is at logic '0'. This is useful to quickly differentiate a '0' from a '1'.



### 3.5 Parallel Decoding

Shows the hexadecimal value of the 8 bit digital input lines. The hexadecimal number is shown below the last digital trace. If all the 8 digital traces are enabled, then there is no space to show the parallel decoding.

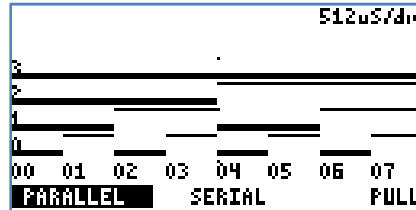

Figure 37: Parallel Decoding

### 3.6 Serial Decoding

Shows the hexadecimal value of the stream of bits on each channel. The decoding starts at the first vertical cursor and ends at the second vertical cursor, 8 bits are decoded. If the cursors are disabled, then the decoding is done from the start of the screen, to the end. The data can be decoded MSB first or LSB first, depending on the position of the first vertical cursor.

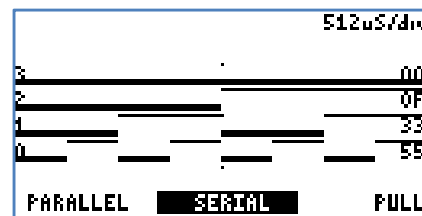

Figure 38: Serial Decoding

### 3.7 Protocol Sniffer

When the Xminilab is in Sniffer mode, a small text appears on the screen, indicating where to hook up the signals. As soon as the data is received, the data is displayed in "pages".

There are 16 pages of data. To browse thru the pages, use the buttons K2 and K3.

In the UART and SPI sniffers, the data can be displayed in HEX or ASCII, press K2 and K3 simultaneously to toggle between them. If using ASCII, note that letters will be always uppercase, and only codes 0x20 thru 0x7A will show valid characters.

To stop and start the sniffer, press the K1 button

### 3.8 Sniffers Modes

- **Normal** mode: Continuous operation, when the buffer is filled, all pages are erased and the index goes back to page 1
- **Single** mode: The sniffer will stop when the buffer is filled.
- **Circular** mode: New data will be placed at the end of the last page and older data will be shifted towards the first page



## 4. Arbitrary Waveform Generator



The Xminilab has an embedded arbitrary waveform generator. The waveform generator is independent autonomous module that is always running in the background. You can adjust all the parameters of the waveform: frequency, amplitude, offset and duty cycle. Figure 41 shows the AWG Menus.

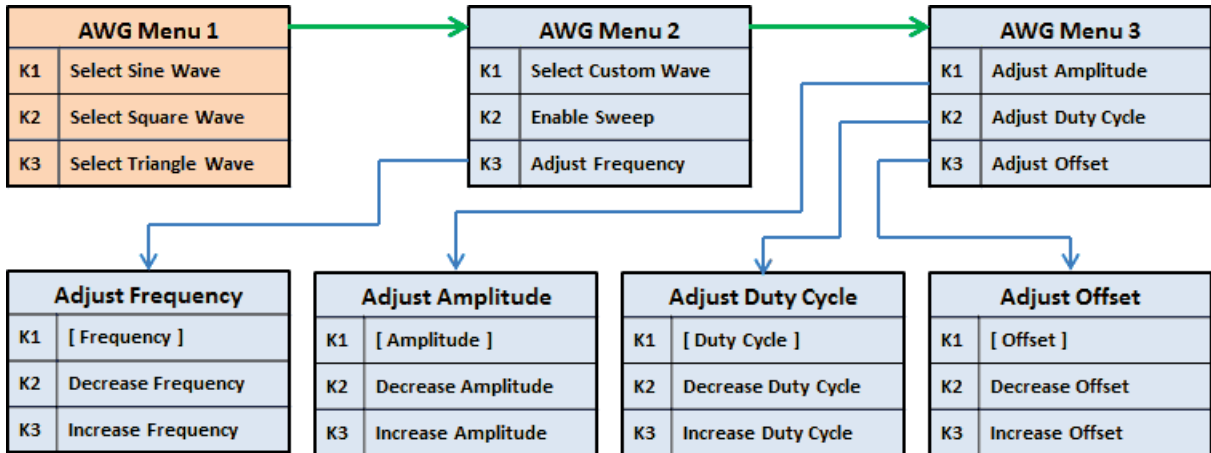

Figure 40: AWG Menus



When adjusting the parameters, the K1 button serves as a shortcut key, which sets predefined values.

### 4.1 Predefined Waveforms

The Xminilab can output the standard waveforms of a function generator: sine, triangle and square. It can also output a custom waveform, which is initially set with an exponential.

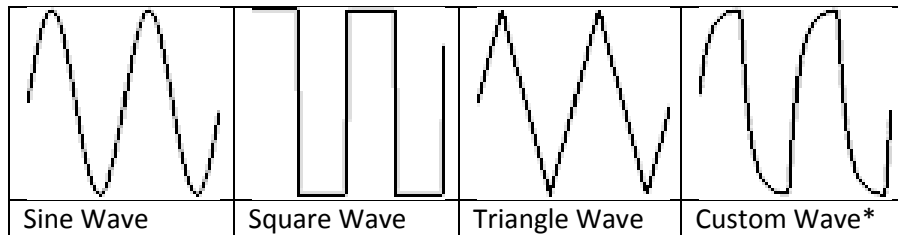

Table 5

\* The custom wave is preset with an exponential, but can be changed with the [PC Xminilab Interface](#).

### 4.2 Frequency Sweep

The Xminilab has a SWEEP feature, which increases the frequency of the wave automatically on each screen refresh of the oscilloscope. The start and end frequencies are automatically determined by the current sampling rate. Since the sweep is synchronized with the oscilloscope, displaying perfect frequency plots is a breeze. To make a frequency plot, set the mode to FFT, and set the display to persistent.



## 4.3 Technical Details

The waveform is stored in a 256 byte long buffer, this buffer is fed to the XMEGA's DAC thru the DMA. Once the waveform is set, the waveform will be generated without any CPU intervention. The maximum conversion rate of the DAC is 1Msps, this limits the maximum output frequency of the AWG as a system. For example, if the AWG is generating a sinewave with 256 points, the maximum frequency is 3906.25Hz. If generating a sinewave with only 32 points, the maximum frequency is 31.25KHz. The AWG amplifier has a low pass filter of 44.1KHz.

The predefined AWG Frequency range is: 1.91Hz thru 125 kHz

The resolution of the waveform generator varies depending on the frequency range: the lower the frequency, the higher the resolution:

$$Frequency = Cycles * \frac{125000}{Period + 1}$$

Cycles: Integer number, with these possible values: 1,2,4,8

Period: Integer number, with values between 0 and 65535

Note that the possible frequencies are discrete.

## 5. PC Interface

The Xminilab can communicate to a PC using the USB port. Figure 42 shows a snapshot of the PC interface. A more detailed description regarding the PC interface will be available in the PC application's help.

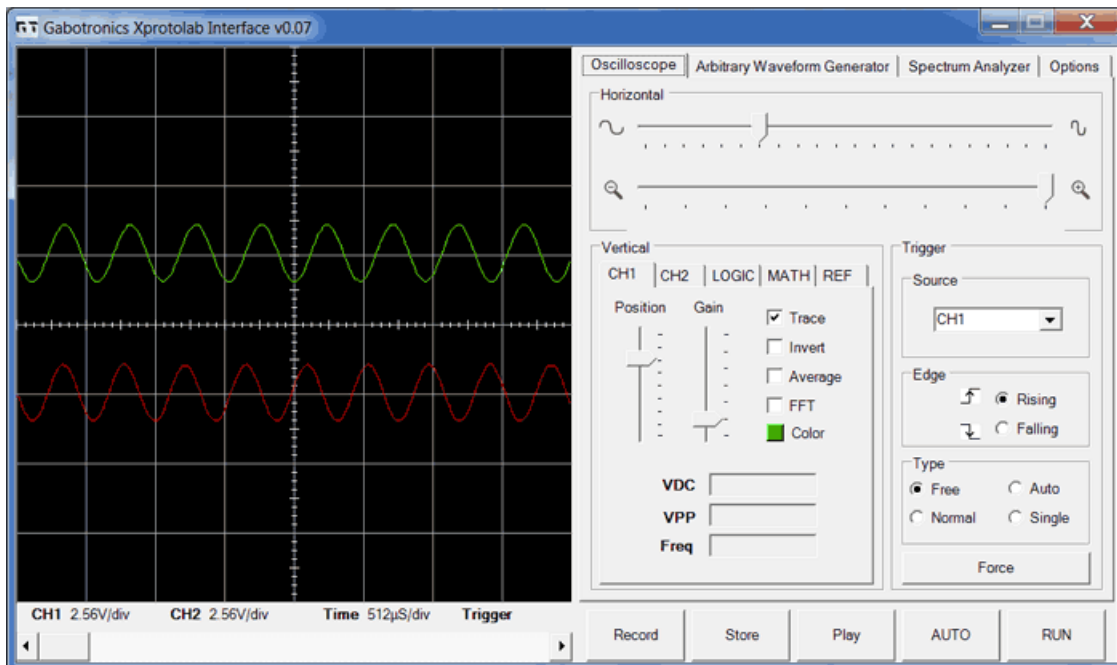

Figure 41: Xminilab PC interface

## 6. Interface Protocol



The Xminilab can communicate to external devices thru the serial port using the Interface Protocol. Follow the protocol to make your own applications to interface the Xminilab, or to port the PC application to other platforms.

### 6.1 UART settings

Data Bits: 8

Baud rate: 115200

Parity: None

Stop Bits: One

Handshaking: None

### 6.2 Control data

#### 6.2.1 CH1 and CH2 settings (3 bytes)

1) Channel Position

2) Option (bitfield):

Bit 0: Channel on

Bit 1: x10 probe

Bit 2: x100 probe

Bit 3: x1000 probe

Bit 4: Invert channel

Bit 5: Average samples

Bit 6: Math Active (either addition or multiplication)

Bit 7: Math operation (addition or multiplication)

3) Channel Gain

#### 6.2.2 CHD settings (5 bytes)

1) Channel Position

2) Input Mask

3) Option (bitfield):

Bit 0: Channel on

Bit 1: Invert channel

Bit 2: Thick line when logic '0'

Bit 3: Pull input

Bit 4: Pull up / down



## 4) Decode parameters (bitfield):

Bit 0: SPI Clock Polarity

Bit 1: SPI Clock Phase

Bit 2: Use UART parity

Bit 3: UART parity odd or even

Bit 4: UART 1 or 2 stop bits

Bit 5,6,7: UART Baud rate (1200, 2400, 4800, 9600, 19200, 38400, 57600, 115200)

## 5) Decode option (bitfield):

Bit 0: Serial Hex Display

Bit 1: Parallel Hex Display

Bit 2: I2C decoding

Bit 3: RS232 decoding

Bit 4: SPI decoding

Bit 5: Use ASCII with RS232

### 6.2.3 General settings (10 bytes)

## 1) Trigger, Cursors

Bit 0: Free trigger \*

Bit 1: Normal trigger \*

Bit 2: Single trigger \*

Bit 3: Auto trigger \*

Bit 4: CH1 Horizontal Cursor on

Bit 5: CH2 Horizontal Cursor on

Bit 6: Vertical Cursor on

Bit 7: Lock Automatic Cursors

\* Only one trigger type must be set

## 2) FFT Options (bitfield):

Bit 0: Hamming window

Bit 1: Hann window

Bit 2: Cosine window

Bit 3: unused

Bit 4: Apply logarithm to FFT

Bit 5: Calculate VDC

Bit 6: Calculate VPP

## 3) MSO settings (bitfield):

Bit 0: AWG sweep

Bit 1: Trigger falling or rising

Bit 2: Scope stopped

Bit 3: unused



Bit 4: Mode MSO \*

Bit 5: Mode Multimeter \*

Bit 6: Mode FFT \*

Bit 7: Mode X-Y \*

\* Only one mode must be set

4) Sampling rate

5,6) Number of Post Trigger samples (unsigned int 16)

7) Trigger source:

1: CH1

2: CH2

3-10: CHD

11: External Trigger

8) Horizontal position

9) Display options (bitfield):

Bit 0,1: Grid Type

Bit 2: Reference waveforms on

Bit 3: Persistent Display

Bit 4: Continuous Drawing

Bit 5: Show scope settings ( time/div volts/div)

Bit 6: Invert Display

Bit 7: Flip Display

10) Trigger Level

### 6.2.4 AWG settings (8 bytes when sending to PC / 9 bytes when sending to device)

#### Sending to PC:

- 1) Cycles in buffer (unsigned byte)
- 2) Amplitude (signed byte, range: [-128, 0])
- 3) Waveform type (1: Sine, 2: Square, 3: Triangle, 4: Custom)
- 4) Duty cycle (unsigned byte), range: [0, 255]
- 5) Sweep type (unsigned byte, currently unused)
- 6) Offset (signed byte)
- 7-8) Actual period of timer used generate waveform (unsigned int 16)

#### Sending to device:

- 1) Amplitude
- 2) Waveform type
- 3) Duty cycle
- 4) Sweep
- 5) Offset
- 6-9) Desired frequency multiplied by 100 (unsigned int 32)

## 6.3 Command Set

All commands sent to the Xminilab are in ASCII format, further data sent or received is in binary. Table 6 shows the Xminilab Interface Protocol Command Set.



| Command | Description              | Xminilab Response                                                                                                                                                                                                                                                                                                                                                                               |
|---------|--------------------------|-------------------------------------------------------------------------------------------------------------------------------------------------------------------------------------------------------------------------------------------------------------------------------------------------------------------------------------------------------------------------------------------------|
| CR      | Simulate KD key press    | No response                                                                                                                                                                                                                                                                                                                                                                                     |
| /       | Simulate KA key press    | No response                                                                                                                                                                                                                                                                                                                                                                                     |
| *       | Simulate KB key press    | No response                                                                                                                                                                                                                                                                                                                                                                                     |
| -       | Simulate KC key press    | No response                                                                                                                                                                                                                                                                                                                                                                                     |
| +       | Auto Setup               | No response                                                                                                                                                                                                                                                                                                                                                                                     |
| .       | Change mode              | No response                                                                                                                                                                                                                                                                                                                                                                                     |
| 0       | Stop                     | No response                                                                                                                                                                                                                                                                                                                                                                                     |
| 9       | Increase sampling rate   | No response                                                                                                                                                                                                                                                                                                                                                                                     |
| 6       | Decrease sampling rate   | No response                                                                                                                                                                                                                                                                                                                                                                                     |
| 1       | Toggle CH1 on/off        | No response                                                                                                                                                                                                                                                                                                                                                                                     |
| 2       | Toggle CH2 on/off        | No response                                                                                                                                                                                                                                                                                                                                                                                     |
| 3       | Toggle CHD on/off        | No response                                                                                                                                                                                                                                                                                                                                                                                     |
| 4       | Decrease CH1 gain        | No response                                                                                                                                                                                                                                                                                                                                                                                     |
| 5       | Decrease CH2 gain        | No response                                                                                                                                                                                                                                                                                                                                                                                     |
| 7       | Increase CH1 gain        | No response                                                                                                                                                                                                                                                                                                                                                                                     |
| 8       | Increase CH2 gain        | No response                                                                                                                                                                                                                                                                                                                                                                                     |
| a       | Request firmware version | String containing the version number followed by a line feed                                                                                                                                                                                                                                                                                                                                    |
| p       | Disable Auto send        | No response                                                                                                                                                                                                                                                                                                                                                                                     |
| q       | Enable Auto send         | No response<br>When the Auto send is active, the Xminilab will continuously send data, this is to maximize the refresh rate on the PC side.<br>When using fast sampling rates, the Xminilab will first fill its buffers, and then send the buffers in bursts.<br>When using slow sampling rates, the PC app will need to keep track of time, as the samples will arrive with no time reference. |
| r       | Request CH1              | CH1 data (256 bytes)                                                                                                                                                                                                                                                                                                                                                                            |
| s       | Request CH2              | CH2 data (256 bytes)                                                                                                                                                                                                                                                                                                                                                                            |
| t       | Request CHD              | CHD data (256 bytes)                                                                                                                                                                                                                                                                                                                                                                            |
| u       | Request settings         | CH1 settings (3 bytes),<br>CH2 settings (3 bytes),<br>CHD settings (5 bytes),<br>General settings (10 bytes),<br>AWG settings (8 bytes)                                                                                                                                                                                                                                                         |
| v       | Send settings            | 'G' character, which signals the PC that the Xminilab is ready,<br>Then the PC sends the data:<br>CH1 settings (3 bytes),<br>CH2 settings (3 bytes),<br>CHD settings (5 bytes),<br>General settings (10 bytes),<br>AWG settings (9 bytes)<br>Then the Xminilab sends a 'T' character, which signals the PC that the data was received.                                                          |
| w       | Request EE waveform      | EE Wave data (256 bytes)                                                                                                                                                                                                                                                                                                                                                                        |
| x       | Send EE waveform         | 'G' character, which signals the PC that the Xminilab is ready,<br>Then the PC sends the data: EE wave (256 bytes)<br>Then the Xminilab sends a 'T' character, which signals the PC that the data was received.                                                                                                                                                                                 |
| C       | Request BMP              | 128x64 Monochrome BMP using the <a href="#">XModem protocol</a>                                                                                                                                                                                                                                                                                                                                 |

Table 6: Xminilab Command Set



## 7. BMP Screen Capture



### 7.1 To send a BMP screen capture to a PC:

You can send a screen capture of the oscilloscope to your PC using HyperTerminal. All oscilloscope bitmaps in this manual were generated using this method.

- Open HyperTerminal.
- Enter a name for a new connection (example: scope).
- Enter the COM port where the device is connected.
- Select 115200 bits per second, 8 data bits, Parity None, 1 Stop bit, Flow control None. (See figure 43)



Figure 42: HyperTerminal Settings

- In the Transfer menu, select Receive File.
- Enter a folder where to save the file and use the XMODEM protocol. (See figure 44)



Figure 43: Receive File Settings

- Enter a file name with a BMP extension and press OK

## 7.2 To send a BMP screen capture to Linux:

Create the following script and save as capture.sh:



[capture.sh](#)

```
echo "Please enter filename. e.g  
capture.bmp"  
read name  
stty -F $1 115200  
rx -c $name < $1 > $1
```

To use, make the script executable with “`chmod +x capture.sh`”. Then enter “`./capture.sh`” into a terminal followed by the serial device for example “`./capture.sh /dev/ttyUSB0`”.

Then enter a name for the bmp image including the .bmp file extension.

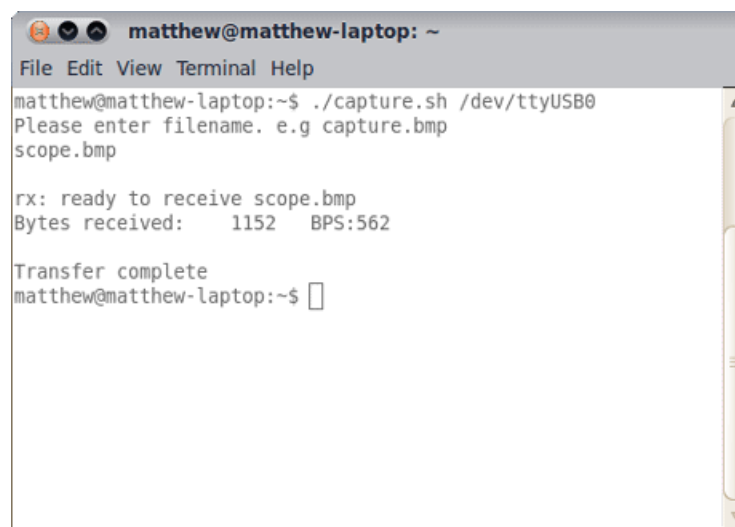

## 8. Firmware Updating

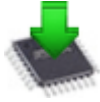

This guide will show how to upgrade the firmware on your AVR XMEGA based device.

### 8.1 Firmware upgrade using an external programmer

#### 8.1.1 Tools required

- [AVRISP mkII](#), or similar PDI capable programmer
- [AVR Studio 4 IDE](#) (Integrated Development Environment)
- HEX and EEP files for the device, found on the product's page (Look for the HEX icon).

**A regular AVR programmer might not work, the programmer needs to be PDI capable. PDI is the new interface to program XMEGA microcontrollers.**

#### 8.1.2 Instructions to install the tools

- Install AVR Studio and USB driver
- Connect the programmer to the computer and auto install the hardware

A more detailed guide on how to install the tools is found [here](#):

[http://www.atmel.com/dyn/resources/prod\\_documents/AVRISPMkII\\_UG.pdf](http://www.atmel.com/dyn/resources/prod_documents/AVRISPMkII_UG.pdf)

#### 8.1.3 Instructions to update the firmware

1. Start AVR Studio
2. Connect the cable from the AVRISP to the PDI connector on the board
3. Power the board
4. Press the "Display the 'Connect' dialog" button: . Alternatively, you can go to this menu: Tools-> Program AVR -> Connect -
5. Select your programmer and port. (AVRISP mkII and AUTO or USB)
6. In the MAIN tab, select the device: ATXMEGA32A4
7. In the programming mode, select PDI
8. To check that everything is ok, press the "Read Signature" button. You will see a message saying that the device matches the signature.
9. Go to the PROGRAM tab
10. In the Flash section, look for the .HEX file and click Program
11. In the EEPROM section, look for the .EEP file and click Program
12. Go to the FUSES tab
13. Set BODPD to BOD enabled in sampled mode
14. Set BODACT to BOD enabled in sampled mode
15. Set BODLVL to 2.9V
16. Click Program
17. After updating the firmware, make sure to recalibrate the device.



## 8.2 Firmware upgrade using the bootloader

### 8.2.1 Tools required

- USB type A to micro USB cable
- [Atmel's FLIP software](#)
- HEX and EEP files for the device, found on the product's page (Look for the HEX icon).

### 8.2.2 Activating the bootloader

The K1 button needs to be pressed while connecting the device to the computer with the USB cable. Once the Xprotolab enters the bootloader, the red LED will be lit, and will blink with USB activity. The Xprotolab will appear as a new device on the host computer, the drivers required are found in the FLIP application folder.

### 8.2.1 FLIP application instructions

- 1) Start Flip.
- 2) Select ATXMEGA32A4U in the device selection list.
- 3) Select USB as communication medium
- 4) Open the USB port to connect to the target
- 5) Make sure the FLASH buffer is selected and check ERASE, BLANK CHECK, PROGRAM, VERIFY.

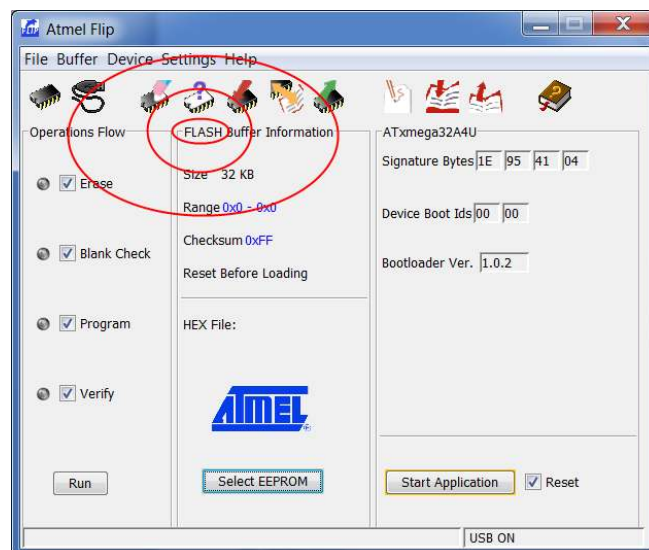

- 6) Load the HEX file Xminilab.hex
- 7) Press RUN
- 8) Press SELECT EEPROM
- 9) Load the HEX file Xminilab.eep
- 10) Uncheck ERASE and BLANK CHECK, only leave checked PROGRAM and VERIFY
- 11) Press RUN
- 12) Press START APPLICATION

## 9. Frequently Asked Questions

### 1) What tools do I need to develop my own programs on the Xminilab?

Besides the power supply, you need an external programmer, such as the [AVR ISP 2](#), or a debugger, such as the [AVR JTAGICE mkII](#) or the [AVR ONE!](#).

Software Tools:

- Integrated Development Environment: [AVR Studio 4](#)
- C Compiler, included in the WinAVR package: [WinAVR at sourceforge](#)

### 2) Can the waveform generator and the oscilloscope run simultaneously?

Yes, the waveform generator runs on the background. (The AWG uses the DMA, so it doesn't need any CPU intervention).

### 3) How do I power the Xminilab?

The Xminilab can be powered thru the micro USB port. Alternatively, the Xminilab can be powered by connecting a 5V power supply on the 5V pin. Do not connect a 5V power supply and the USB at the same time.

### 4) Can I connect the Xminilab to the computer to control the oscilloscope and get the data?

Yes, you can use the [Xminilab PC Interface](#). A [UART to USB cable](#) will be required.

### 5) Can I connect the Xminilab to the computer using the USB for firmware updates?

No, a PDI programmer will be needed for firmware updates.

### 6) How much power can the Xminilab supply?

The Xminilab can also power external devices. This is the maximum current on each voltage:

**+5V:** Will be the same as the power source minus 60mA.

**+3.3V:** Approximately 200mA, but this subtracts from the available current on the +5V line.

### 7) What is the maximum frequency that I can measure with the Xminilab?

The analog bandwidth is set at 200kHz. However, you can still measure frequencies up to almost Nyquist/2, i.e. 1MHz. The FFT analysis will be particularly useful to measure high frequencies.

### 8) Can I measure voltages above 20V?

Yes, by adding a 9Mohm resistor on the input. Since the input impedance of the device is 1Mohm, the voltage will be divided by 10 (This is the equivalent of using a 10:1 probe).

### 9) Are the logic inputs 5V tolerant?

No, the logic inputs are not 5V tolerant. An easy solution would be to place a 3K resistor in series with the 5V signal, this will work for signals with a frequency lower than 200kHz. Another solution would be to use a voltage translator chip.





**10) The source code says "evaluation version", can I get the full version?**

The full source code is currently not open. The evaluation source code does not contain the MSO application. The HEX file does contain the full version of the oscilloscope.

**11) What is the current consumption of the Xminilab?**

Between 40mA and 60mA, depending on how many pixels are lit on the OLED.

**12) There is a new firmware for the Xminilab, how do I update?**

Follow the instructions on section 8.

**13) How does the Xminilab compare to other digital oscilloscopes?**

You can check this comparison table: <http://www.gabotronics.com/resources/hobbyists-oscilloscopes.htm>

## 10. Troubleshooting



Is the Xminilab not working? Check out these tips:

**1) The unit does not power up**

If using the USB connector to power, try applying 5V directly instead with another power supply.

**2) The unit powers up but the MSO is not working**

Try restoring the default settings: Press K4 during power up, then select "Restore"

**3) The screen turns off after a certain amount of time**

This is the screen saver in action. The screen saver time can be changed in factory options, to disable this feature, set a time equal to 0.

**4) A particular button doesn't work**

There might be shorted pins on the microcontroller. Check for debris or solder bridges. Using a solder wick on the pins will help.

**5) When powering up, the splash screen stays for a very long time (more than 4 seconds)**

The crystal is defective or the traces on the crystal are shorted.

**6) It still isn't working!**

If you have a multimeter and want to try to fix yourself, check the following voltages. If any of the voltages are wrong, there might be a defective part.

- Voltage at +5V should be between +4.75 and +5.25V
- Voltage at -5V should be between -4.75 and -5.25V
- Voltage at +3.3V should be between +3.2 and +3.4V
- Voltage at pin 8 of U3 should be between +2.00 and +2.09V

**TIP**

If the unit is powered with more than 5.5V, the negative voltage generator would be the first component to get damaged.

**If all fails and if the device is under warranty, you can send it back for repairs.**



## 11. Xminilab Design

### 11.1 System Architecture

The Xminilab uses many resources and peripherals of the XMEGA microcontroller. Figure 45 shows the Xminilab's Architecture block diagram.

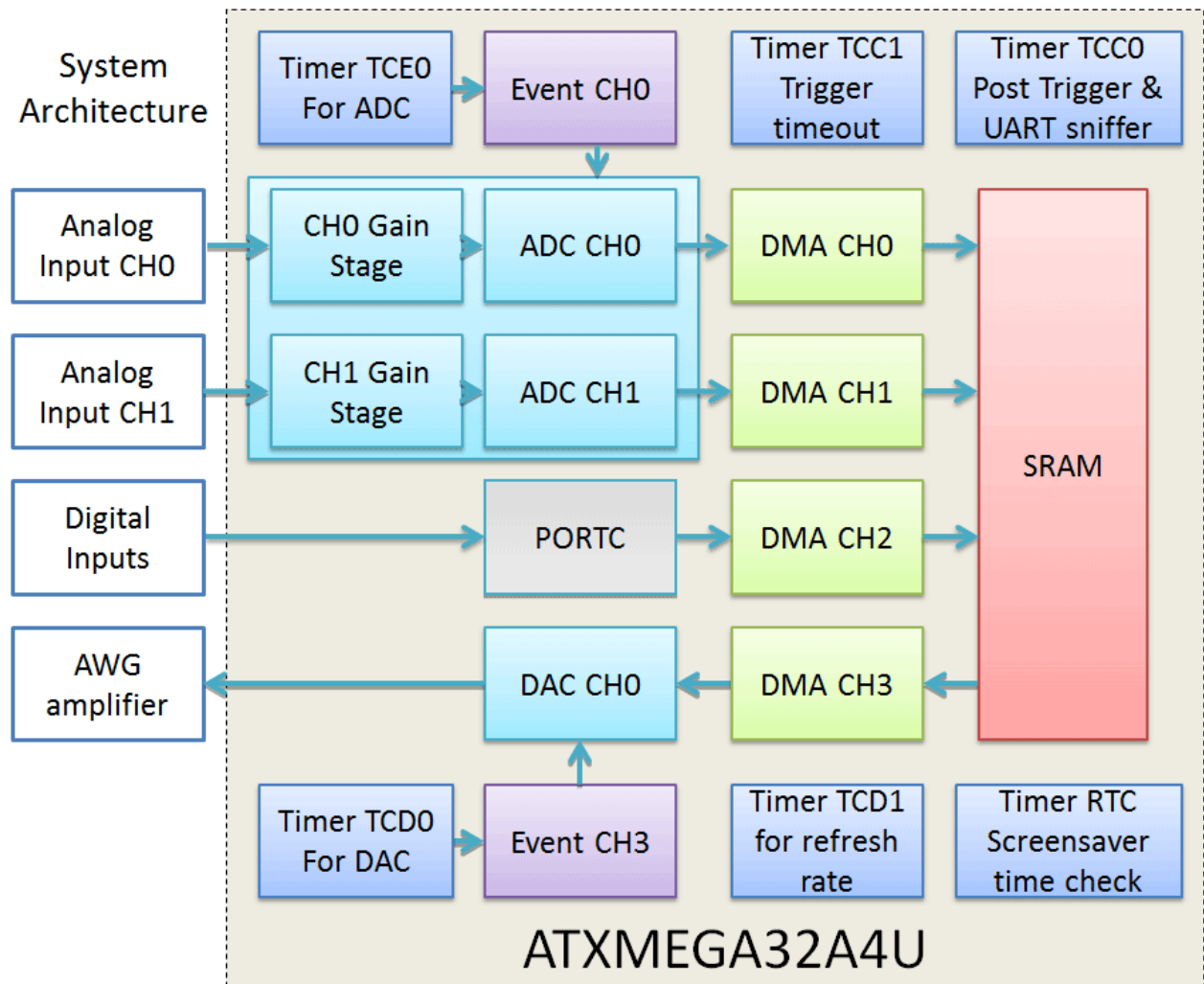

Figure 44: Xminilab Architecture Block Diagram

## 11.2 Schematics

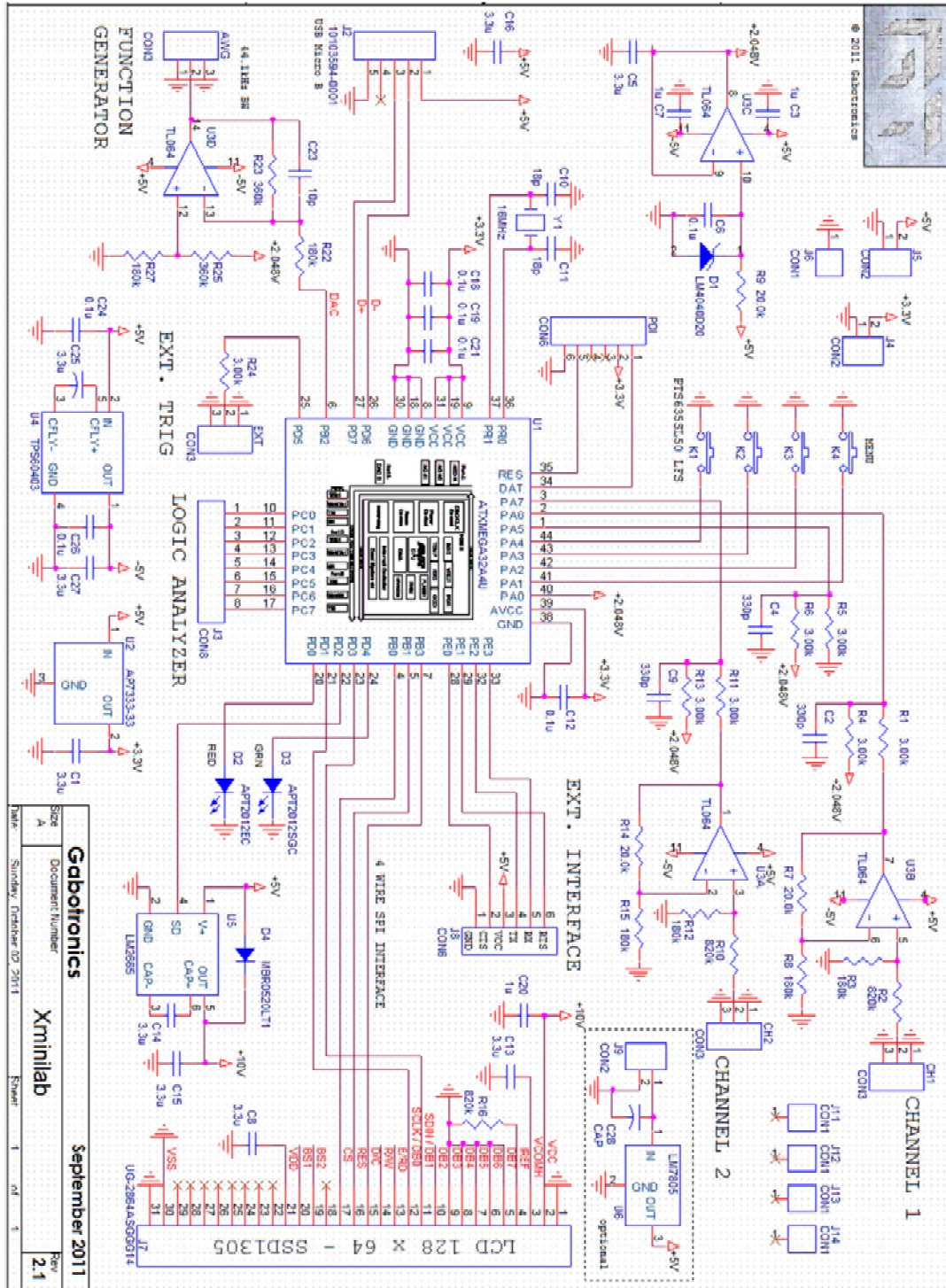

Figure 45: Xminilab Schematic

