

Roland 

UM-4 USB MIDI INTERFACE

Super MPU64

OWNER'S MANUAL

We'd like to take a moment to thank you for purchasing the Roland UM-4 (64 Channel USB MIDI Interface). This document explains how to set up the UM-4 system. To avoid problems and enjoy optimal performance, please carefully follow the setup instructions described in this document.

Before using this unit, carefully read the sections entitled: **"USING THE UNIT SAFELY"** (P. 3, 4) and **"IMPORTANT NOTES"** (P. 5). These sections provide important information concerning the proper operation of the unit. Additionally, in order to feel assured that you have gained a good grasp of every feature provided by your new unit, this manual should be read in its entirety. The manual should be saved and kept on hand as a convenient reference.

Copyright © 1999 ROLAND CORPORATION
All rights reserved. No part of this publication may be reproduced in any form without the written permission of ROLAND CORPORATION.



This product complies with the requirements of European Directive 89/336/EEC.

FEDERAL COMMUNICATIONS COMMISSION RADIO FREQUENCY INTERFERENCE STATEMENT

This equipment has been tested and found to comply with the limits for a Class B digital device, pursuant to Part 15 of the FCC Rules. These limits are designed to provide reasonable protection against harmful interference in a residential installation. This equipment generates, uses, and can radiate radio frequency energy and, if not installed and used in accordance with the instructions, may cause harmful interference to radio communications. However, there is no guarantee that interference will not occur in a particular installation. If this equipment does cause harmful interference to radio or television reception, which can be determined by turning the equipment off and on, the user is encouraged to try to correct the interference by one or more of the following measures:

- Reorient or relocate the receiving antenna.
- Increase the separation between the equipment and receiver.
- Connect the equipment into an outlet on a circuit different from that to which the receiver is connected.
- Consult the dealer or an experienced radio/TV technician for help.

Unauthorized changes or modification to this system can void the users authority to operate this equipment. This equipment requires shielded interface cables in order to meet FCC class B Limit.

NOTICE

This Class B digital apparatus meets all requirements of the Canadian Interference-Causing Equipment Regulations.

AVIS

Cet appareil numérique de la classe B respecte toutes les exigences du Règlement sur le matériel brouilleur du Canada.

USING THE UNIT SAFELY

INSTRUCTIONS FOR THE PREVENTION OF FIRE, ELECTRIC SHOCK, OR INJURY TO PERSONS

About WARNING and CAUTION Notices

WARNING	Used for instructions intended to alert the user to the risk of death or severe injury should the unit be used improperly.
CAUTION	Used for instructions intended to alert the user to the risk of injury or material damage should the unit be used improperly. * Material damage refers to damage or other adverse effects caused with respect to the home and all its furnishings, as well to domestic animals or pets.

About the Symbols

	The symbol alerts the user to important instructions or warnings. The specific meaning of the symbol is determined by the design contained within the triangle. In the case of the symbol at left, it is used for general cautions, warnings, or alerts to danger.
	The symbol alerts the user to items that must never be carried out (are forbidden). The specific thing that must not be done is indicated by the design contained within the circle. In the case of the symbol at left, it means that the unit must never be disassembled.
	The symbol alerts the user to things that must be carried out. The specific thing that must be done is indicated by the design contained within the circle. In the case of the symbol at left, it means that the power-cord plug must be unplugged from the outlet.

ALWAYS OBSERVE THE FOLLOWING

WARNING

- Before using this unit, make sure to read the instructions below, and the Owner's Manual.
- Do not open or perform any internal modifications on the unit.

WARNING





- Do not attempt to repair the unit, or replace parts within it (except when this manual provides specific instructions directing you to do so). Refer all servicing to your retailer, the nearest Roland Service Center, or an authorized Roland distributor, as listed on the "Information" page.

WARNING



- Never use or store the unit in places that are:
 - Subject to temperature extremes (e.g., direct sunlight in an enclosed vehicle, near a heating duct, on top of heat-generating equipment); or are
 - Damp (e.g., baths, washrooms, on wet floors); or are
 - Humid; or are
 - Exposed to rain; or are
 - Dusty; or are
 - Subject to high levels of vibration.
- Make sure you always have the unit placed so it is level and sure to remain stable. Never place it on stands that could wobble, or on inclined surfaces.
- Avoid damaging the USB cable. Do not bend it excessively, step on it, place heavy objects on it, etc. A damaged cord can easily become a shock or fire hazard. Never use a power cord after it has been damaged.
- Do not allow any objects (e.g., flammable material, coins, pins); or liquids of any kind (water, soft drinks, etc.) to penetrate the unit.
- Immediately turn the power off, and request servicing by your retailer, the nearest Roland Service Center, or an authorized Roland distributor, as listed on the "Information" page when:
 - Objects have fallen into, or liquid has been spilled onto the unit; or
 - The unit has been exposed to rain (or otherwise has become wet); or
 - The unit does not appear to operate normally or exhibits a marked change in performance.



WARNING

- In households with small children, an adult should provide supervision until the child is capable of following all the rules essential for the safe operation of the unit. 
- Protect the unit from strong impact. (Do not drop it!) 
- Before using the unit in a foreign country, consult with your retailer, the nearest Roland Service Center, or an authorized Roland distributor, as listed on the "Information" page. 
- DO NOT play a CD-ROM disc on a conventional audio CD player. The resulting sound may be of a level that could cause permanent hearing loss. Damage to speakers or other system components may result. 

CAUTION

- Try to prevent cords and cables from becoming entangled. Also, all cords and cables should be placed so they are out of the reach of children. 
- Never climb on top of, nor place heavy objects on the unit. 
- Disconnect all cords coming from external devices before moving the unit. 

IMPORTANT NOTES

In addition to the items listed under “USING THE UNIT SAFELY” on page 3-4, please read and observe the following:

Power Supply

- Before connecting this unit to other devices, turn off the power to all units. This will help prevent malfunctions and/or damage to speakers or other devices.

Placement

- This device may interfere with radio and television reception. Do not use this device in the vicinity of such receivers.
- To avoid possible breakdown, do not use the unit in a wet area, such as an area exposed to rain or other moisture.

Maintenance

- For everyday cleaning wipe the unit with a soft, dry cloth or one that has been slightly dampened with water. To remove stubborn dirt, use a cloth impregnated with a mild, non-abrasive detergent. Afterwards, be sure to wipe the unit thoroughly with a soft, dry cloth.
- Never use benzene, thinner, alcohol or solvents of any kind, to avoid the possibility of discoloration and/or deformation.

Additional Precautions

- Use a reasonable amount of care when using the unit's buttons, sliders, or other controls; and when using its jacks and connectors. Rough handling can lead to malfunctions.
- When connecting / disconnecting all cables, grasp the connector itself—never pull on the cable. This way you will avoid causing shorts, or damage to the cable's internal elements.
- When you need to transport the unit, package it in the box (including padding) that it came in, if possible. Otherwise, you will need to use equivalent packaging materials.

Handling CD-ROMs

- Avoid touching or scratching the shiny underside (encoded surface) of the disc. Damaged or dirty CD-ROM discs may not be read properly. Keep your discs clean using a commercially available CD cleaner.

Contents

USING THE UNIT SAFELY	3
IMPORTANT NOTES.....	5
Contents	6
Introduction.....	7
1. Features of the UM-4.....	7
2. Contents of the Package.....	8
3. Front and Rear Panel.....	10
Connections.....	11
1. Connections with Your Computer	11
2. Connections with the MIDI Equipment	12
Installing & Setup the Driver	14
Windows Users	15
Using OMS on the Macintosh	21
Using FreeMIDI on the Macintosh.....	29
Appendices	34
1. Connecting Equipment Supporting MTC	34
MTC settings for Macintosh users.....	34
2. When Connecting Multiple UM-4 Units.....	36
3. Deleting the USB MIDI Driver from Windows	39
Troubleshooting	41
Main Specifications	47
System requirements	47

* Microsoft and Windows are registered trademarks of Microsoft Corporation.

* Windows® 98 is known officially as: "Microsoft® Windows® 98 operating system."

* Screen shots reprinted with permission from Microsoft Corporation.

* Apple, Macintosh, MacOS is a registered trademark of Apple Computer, Inc.

* Pentium is a registered trademark of Intel Corporation.

* MMX is a trademark of Intel Corporation.

* OMS is a registered trademark of Opcode Systems, Inc.

* The OMS logo is a trademark of Opcode Systems, Inc.

* Adobe Acrobat is a trademark of Adobe Systems Incorporated.

* All product names mentioned in this document are trademarks or registered trademarks of their respective owners.

* This product uses the power of a computer through a USB cable (AC adapter is not used).

Introduction

1. Features of the UM-4

The UM-4 is a USB MIDI interface which uses USB as its connection to your computer.

What is USB?

USB stands for Universal Serial Bus, which is a new interface for connecting various types of peripheral device to computers.

A single USB cable can be used to connect multiple peripheral devices, and data transmission speed is much faster than the serial port used on previous computers. In addition, peripheral devices can be connected or disconnected without turning off the power, and the computer will automatically detect the device which was connected. (For some peripherals, you may need to make settings or perform other

■ **Four MIDI Ports**

Four MIDI ports (each with MIDI IN/OUT) can be controlled independently.

■ **Four MIDI Indicators**

Convenient MIDI indicators for both input and output allow you to verify MIDI data activity.

■ **Easy Connection to Your Computer with a Single USB Cable**

Connections to your computer can be made even when the power is turned on. No special settings are required.

■ **High-Speed Data Transmission via USB**

High-speed USB connection provides excellent response even with simultaneous playback on multiple channels.

■ **A Maximum of Four Units can be Used Simultaneously**

If a USB hub* is used, you can use up to four UM-4 units simultaneously.

* A device used for adding additional USB connectors.

■ **EIA-1U Half-Rack Size**

A separately sold rack mount adaptor (Roland RAD-50) can be used to rack mount the UM-4.

■ **Power Supply Not Required**

Power is supplied from the computer itself, so a separate power supply is not required.

2. Contents of the Package

The UM-4 package contains the following items. As soon as you open the package, please verify that all items are present. If any items are missing, please contact the dealer where you purchased the package.

□ UM-4 64 Channel USB MIDI Interface

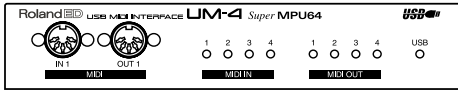

□ "UM Driver CD-ROM" (one disk)

- * Be sure to read the Readme-E.txt file that is found in the UM Driver CD-ROM. Any changes that occurred after the owner's manual was printed or additional information will be given in the Readme-E.txt file.



□ USB Cable (2 m, one cable)

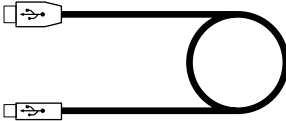

■ UM-4 Owner's Manual (this document)



□ 4 Rubber Feet

■ Before You Begin (Attaching the Rubber Feet)

If you will be using the UM-4 by itself without using the separately sold rack mount adaptor (Roland RAD-50), please attach the rubber feet to the bottom of the unit as shown in the diagram.

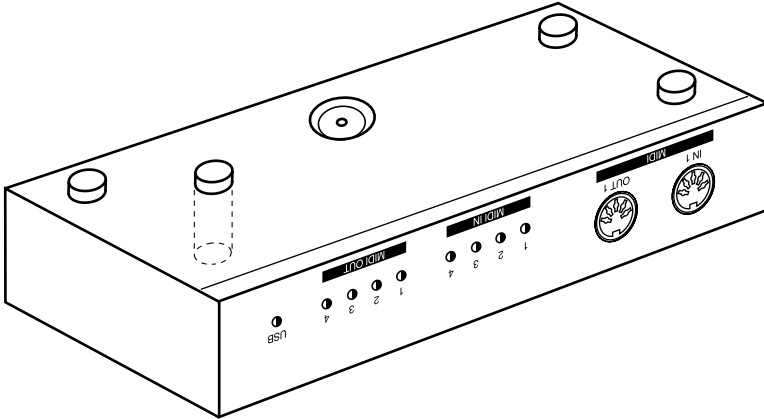

- * If you will be using the separately sold rack mount adaptor (Roland RAD-50), do not attach the rubber feet. Attach the unit using the screws included with the Roland RAD-50.

3. Front and Rear Panel

■ Front Panel

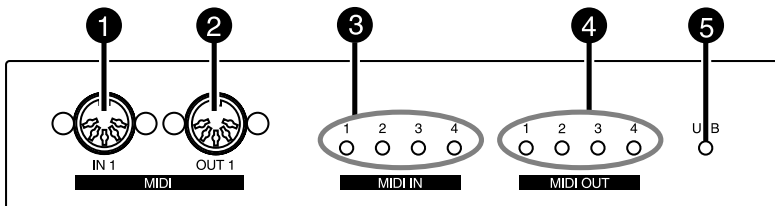

■ Rear Panel

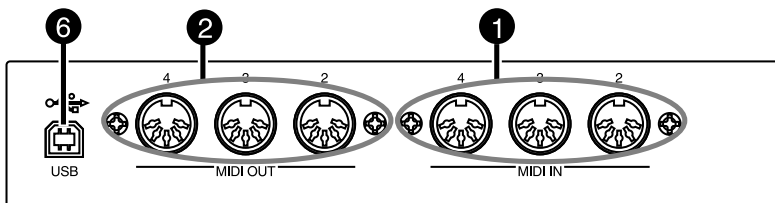

- 1 MIDI IN 1/2/3/4 Connectors**
Connect these to the MIDI OUT connector of the keyboard or other devices that will transmit MIDI messages to your computer.
- 2 MIDI OUT 1/2/3/4 Connectors**
Connect these to the MIDI IN connector of the sound modules or other devices that you wish to play from your computer.
- 3 MIDI IN Indicators 1/2/3/4**
These indicators will blink when MIDI messages are received at the MIDI IN connectors.
- 4 MIDI OUT Indicators 1/2/3/4**
These indicators will blink when MIDI messages are transmitted from the MIDI OUT connectors.
- 5 USB Indicator**
This indicator will light when the unit is connected to your computer and is ready to operate.
- 6 USB Connector**
Use a USB cable to connect this to your computer and a USB hub.

Connections

Here's how to connect the UM-4 to your computer, a sound module or another MIDI device.



This package does not include a MIDI sound module, MIDI cables, or audio cables. You will need to provide your own, or purchase them separately.

1. Connections with Your Computer

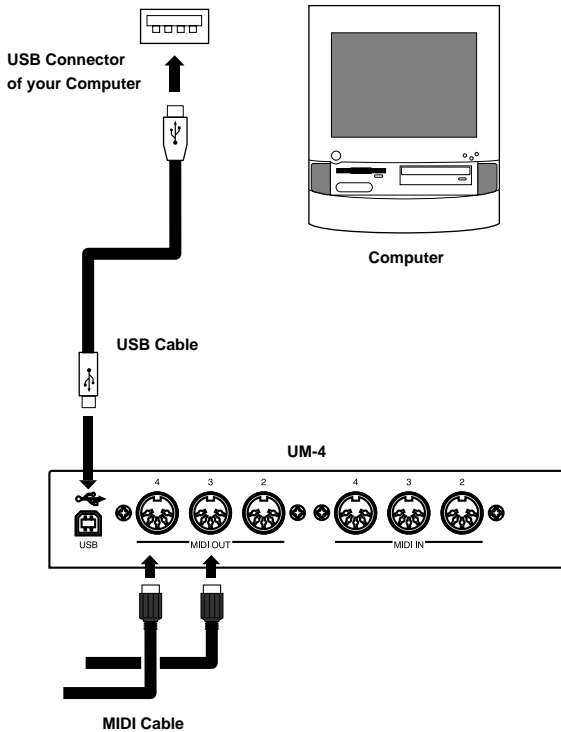

When using a USB cable to connect your computer to the UM-4, it is not necessary to turn off the power of your computer.



When you use a USB cable to connect the UM-4 to your computer for the first time, a dialog box for driver installation will appear. Refer to the procedure " **Installing & Setup the Driver**" (P.14).

2. Connections with the MIDI Equipment

1

Turn off the power of the MIDI device or audio playback system to which you will be making connections.



If your computer is running, it is not necessary to turn off the power of the computer.

2

Use a MIDI cable to connect the UM-4's MIDI OUT connector to the MIDI Sound module's MIDI IN connector.

3

If the MIDI Sound module has 2 port MIDI connectors, use a MIDI cable to connect another MIDI OUT connector of the UM-4 to another MIDI Sound module's MIDI IN connector.

4

Use audio cables to connect the MIDI Sound module's OUTPUT L and R connectors to the input connectors (INPUT, LINE IN, AUX IN, TAPE IN etc.) of your audio playback system.

Be sure to connect the MIDI Sound module's OUTPUT L and R connectors to the L and R connectors of your audio playback system without reversing the left/right connection. If L and R are exchanged, the left/right location from which sounds will be heard will be inverted.

Never make connections to the MIC connectors or PHONE connectors of your audio playback system.

5

If the MIDI Sound module has a Computer switch, set the Computer switch located on the rear panel of the MIDI Sound module to the "MIDI" position.



Before changing the setting of the MIDI Sound module's Computer switch, be sure to turn off the power.

6

Connect the MIDI Sound module's power cable to an electrical outlet.

When you are ready to use the system, turn on the power of the MIDI Sound module and of your audio playback system.

Connecting a MIDI keyboard

If you wish to connect a MIDI keyboard, use a MIDI cable to connect the UM-4's MIDI IN connector to the MIDI OUT connector of your keyboard.

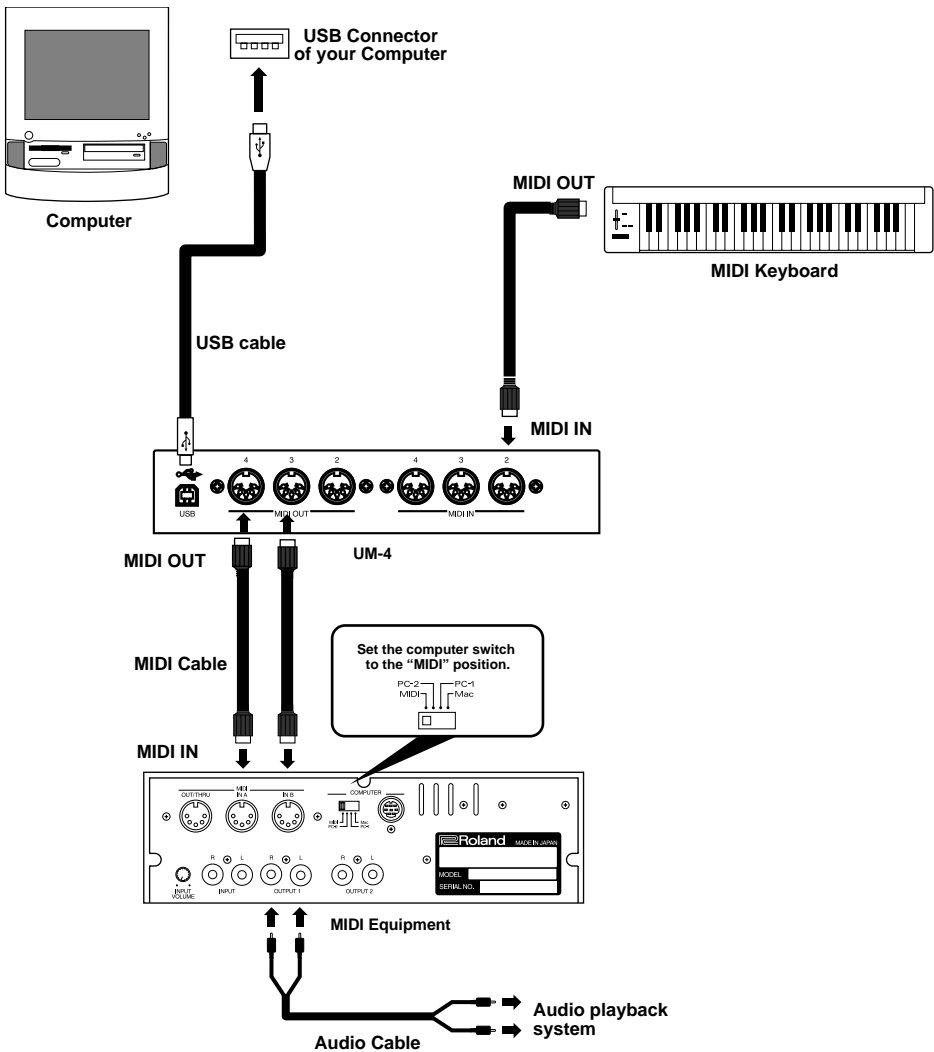

Before turning the power off, be sure to turn down the volume of all devices to avoid speaker damage or malfunctions.



Before disconnecting the USB cable which connects your computer and the UM-4, halt any operations which record or playback MIDI data. This will prevent the sound module etc. from malfunctioning. It is not necessary to turn off the power of your computer.

Installing & Setup the Driver

In order to use the UM-4, you must first install the UM-4 Driver. The UM-4 Driver is included in the “UM Driver CD-ROM.”

■ What is UM-4 Driver?

The UM-4 Driver is software which passes data between the UM-4 and the application (sequencer software etc.) that is running on the USB-connected computer.

The UM-4 Driver sends data from the application to the UM-4, and passes data from the UM-4 to the application.

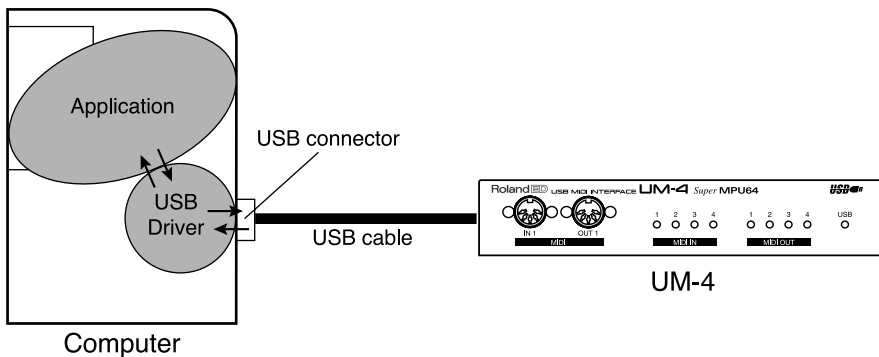

The explanation about installing and setup the driver is organized according to the computer and MIDI driver that you are using. Please proceed to the following pages.

Windows Users → P.15

Using OMS on the Macintosh → P.21

Using FreeMIDI on the Macintosh → P.29

Windows Users



The UM-4 cannot be used with Windows95 or Windows NT.



If other Windows programs are running, please exit all of them before you proceed with the following steps.



If you will be connecting the UM-4 to your computer simultaneously with another Roland USB-compatible device such as the UA-100, you must disconnect the UA-100 (or other device) from the USB connector before installing the USB MIDI driver. If you install the USB MIDI driver while the UA-100 etc. is connected to your computer, the USB MIDI driver may not be installed correctly.

1

Turn on the power of your computer and start Windows. Use a USB cable to connect the UM-4 to your computer (P.11).

The USB-compatible device will be detected automatically, and the “Add new Hardware Wizard” dialog box will appear. Then click [Next].



If this dialog box does not appear, please refer to the "Troubleshooting" section for "Case 1: Cannot install the UM-4 Driver" (P.41).



When a S-MPU64 Has Been Used

If a MIDI driver for the S-MPU64 is currently installed on the computer, it will recognize the UM-4, and treat it as being a S-MPU64. As a result, this dialog box will not be displayed. In this case, you do not need to install the new driver, because the UM-4 can be used as if it were a S-MPU64.

2

When the display indicates “What do you want Windows to do?,” choose [Display a list of all the drivers in a specific location, so you can select the driver you want.]. Then click [Next].

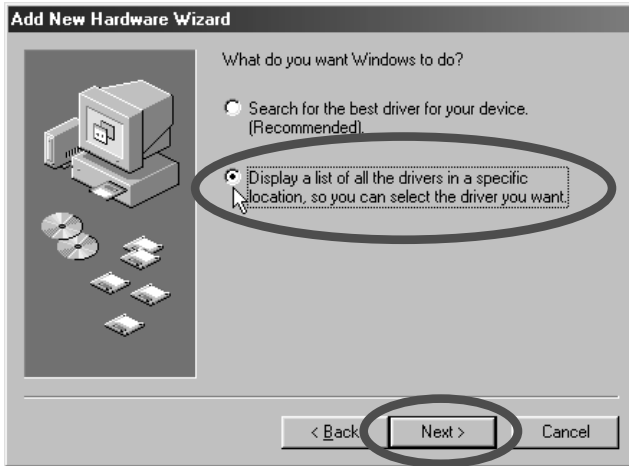

3

When the display indicates “Select the manufacturer and model of hardware device,” click [Have Disk], and insert the UM Driver CD-ROM into your CD-ROM drive.

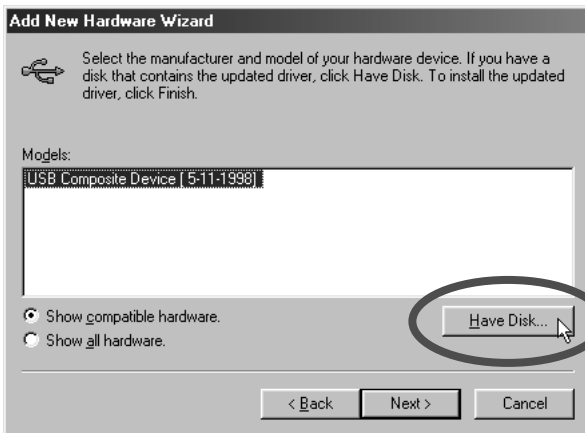

4

Install From Disk will be displayed. For “**Copy manufacturer’s files from,**” input “**D:\ENG\UM4**” and click [**OK**].

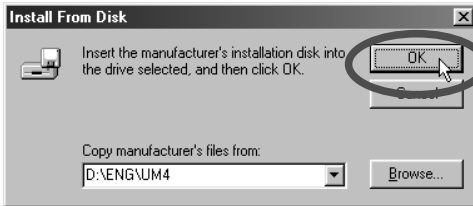

* If necessary, change the drive name D: to match the drive name of your CD-ROM drive. For example if your CD-ROM drive is named Q:, you would input “**Q:\ENG\UM4.**”

5

Make sure that **Roland UM-4 USB Driver** is indicated as the model, as shown below, and click [**Next**].



6

The display will indicate “**Windows driver file search for the device.**” Click [**Next**], and installation of the driver files will begin. Please wait.



7

A dialog box will appear to inform you that the driver installation has been completed. Click [**Finish**].



■ Specifying the Output Destination for MIDI Data

Here you can make settings for using the USB MIDI driver with applications such as the “Media Player” that is included with Windows.

1

Click the Windows **[Start]** button, select **[Settings]** from the menu that appears, and select **[Control Panel]**.

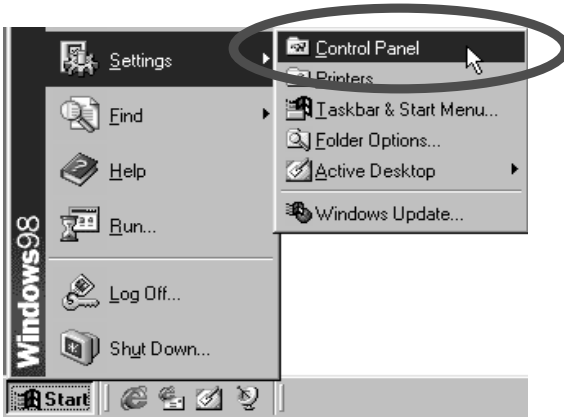
**2**

In the Control Panel, double-click the **[Multimedia]** icon.



3

In **Multimedia Properties**, click the **[MIDI]** tab. Then, with **[Single instrument]** selected for MIDI output, click the MIDI device that corresponds to the MIDI port to which your MIDI equipment is connected via **[Roland UM-4 MIDI 1]** through **[Roland UM-4 MIDI 4]**.

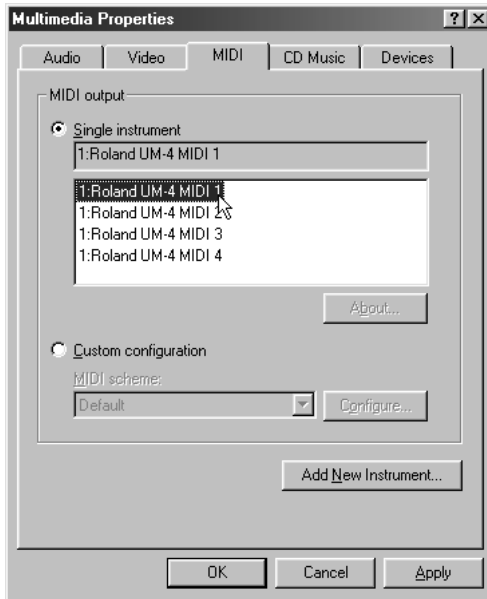

MIDI devices correspond to MIDI ports as follows.

MIDI Output Device	MIDI Output Port
Roland UM-4 MIDI 1	MIDI OUT 1
Roland UM-4 MIDI 2	MIDI OUT 2
Roland UM-4 MIDI 3	MIDI OUT 3
Roland UM-4 MIDI 4	MIDI OUT 4

4

Click **[OK]**.

This completes driver settings.

Using OMS on the Macintosh

■ Installing the MIDI Driver (OMS)

Install the MIDI driver (OMS) into your Macintosh. Turn on the power of your computer and start up your Macintosh. Use a USB cable to connect the UM-4 to your computer (P.11). The message shown in the illustration will appear, so click **[OK]**. Insert the UM Driver CD-ROM into your CD-ROM drive.



1

In the “OMS 2.3.7” folder of the CD-ROM, double-click the “Install OMS 2.3.7” icon.



2

Click **[Continue]**, and verify the location for installation, and click **[Install]**.

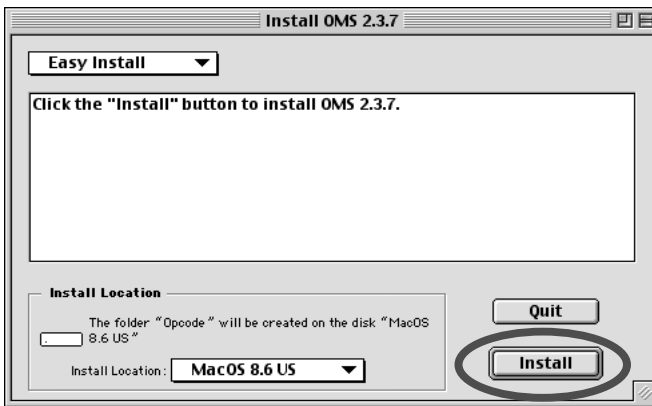

3

If the following dialog box appears, click the button that you need.

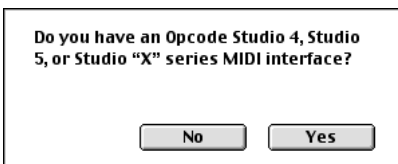

4

If the following dialog box appears, click **[Continue]**.



5

When installation is finished, the following dialog box will appear. Click **[Restart]** to restart your Macintosh.

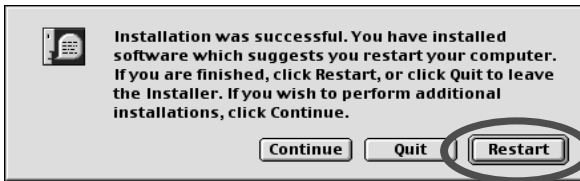

6

After your Macintosh restarts, the following message will appear. Click **[OK]**.

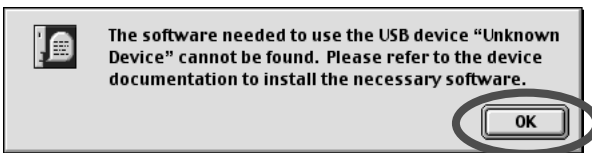

■ To learn more about OMS

If you would like to learn more about OMS, please refer to "**OMS_2.3_Mac.pdf**" (online manual) located in the "**OMS 2.3.7**" folder on the CD-ROM. In order to read "**OMS_2.3_Mac.pdf**," you will need the Adobe Acrobat Reader. To install it, double-click "**Reader Installer**" which is found in the CD-ROM.

■ Installing the UM-4 Driver



When Using S-MPU64

The UM-4 Driver is compatible with the S-MPU64. However, you cannot use the UM-4 Driver and the S-MPU64 Driver at the same time.

If you have already installed the S-MPU64 Driver in your computer, be sure to follow the procedure written below to delete the S-MPU64 Driver and install the UM-4 Driver.

Remove the files in the System folder written below and restart your Macintosh. Then install the UM-4 Driver.

- the “USBSMPU64Driver” file in the “Extensions” folder
- the “SMPU64” file in the “OMS Folder” folder

1

In the “UM Driver E” -“UM-4” folder of the CD-ROM, double-click the “UM4 OMS Driver-E Installer” icon.



UM4 OMS Driver-E Installer

2

Make sure that OMS is already installed in the location where the driver will be installed, and click [Install].



3

If the following message appears, click **[Continue]** and all other currently-running applications will be exited, and installation will continue.



4

When installation is completed, the following dialog box will appear. Click **[Restart]** to restart your Macintosh.

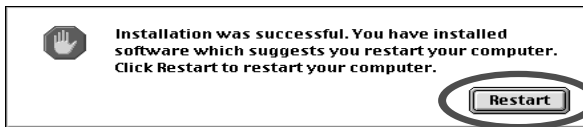

■ OMS settings

1

In the **“Opcode”** folder in the location where OMS is installed, open the **“OMS Applications”** folder, and double-click the **“OMS Setup”** icon.



2

If the **“Apple Talk”** dialog box appears, click **[Turn It Off]**. Then, in the dialog box that appears next, click **[OK]**.



3

The “**Create a New Studio setup**” dialog box will appear. Click **[OK]**.



* If the “**Create a New Studio setup**” dialog box does not appear, click **[New Studio setup]** in the **[File]** menu.

4

The “**OMS Driver Search**” dialog box will appear. Click **[Search]**.

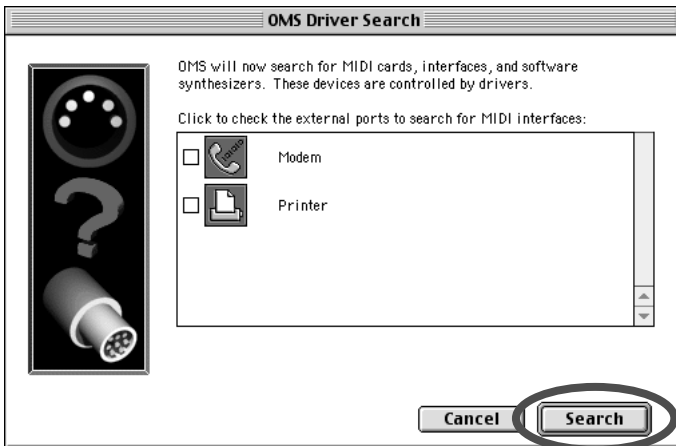

5

After the search has been completed, make sure that “**Roland UM-4**” is listed in the “**OMS Driver Setup**” dialog box, and click [OK].

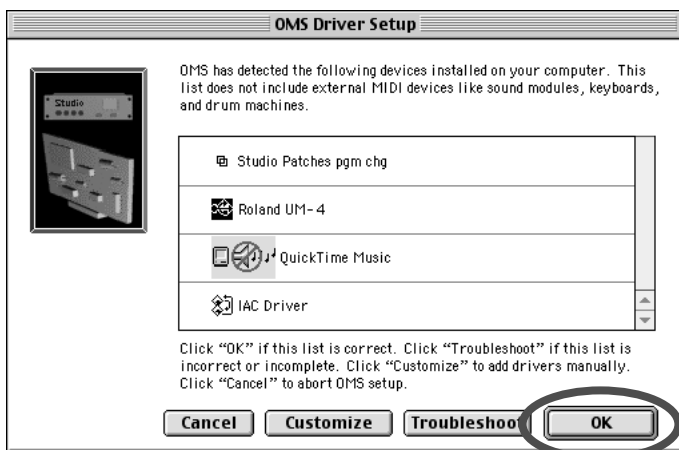

6

After making sure that the UM-4 is listed in the “**OMS MIDI Device Setup**” dialog box, click each **check box for Port1 through Port4** to check them all, and click [OK].

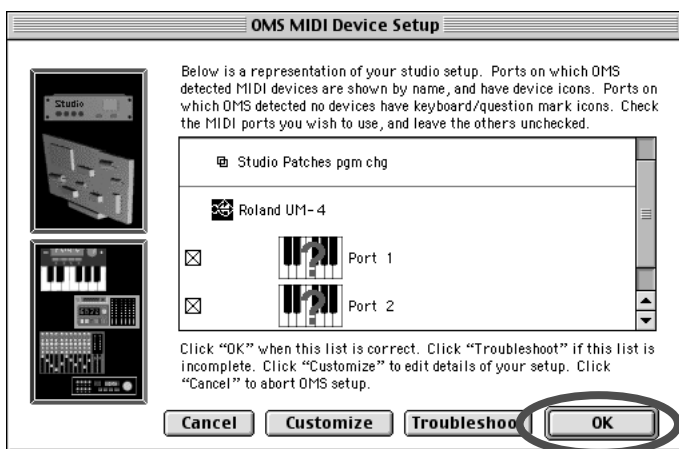

7

The “Save” dialog box will appear. Input the desired file name, and click **[Save]**.

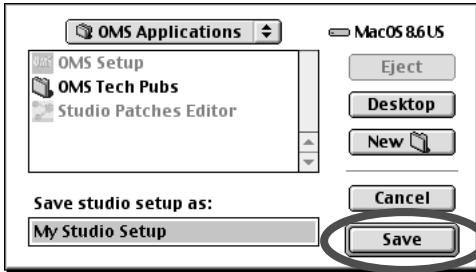

8

If a sound module is connected to a MIDI connector of the UM-4, select **[Test Studio]** in the **[Studio Menu]** and check it in order to Test Studio whether sound is produced.



* The following step will cause a relatively loud sound to be produced by the sound module, so turn down the volume of your sound module before continuing.

9

In the “**My Studio Setup Window**,” click the keyboard icon. When you move the mouse cursor near the keyboard icon, the cursor will change to the shape of an eighth note. Verify that you can hear sound from your sound module.

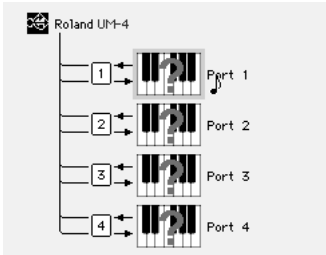

- * Port 1 is MIDI IN / OUT 1 of the UM-4
- Port 2 is MIDI IN / OUT 2 of the UM-4
- Port 3 is MIDI IN / OUT 3 of the UM-4
- Port 4 is MIDI IN / OUT 4 of the UM-4

10

After you have finished the above check, exit OMS Setup.

This completes driver settings.

Using FreeMIDI on the Macintosh



The UM-4 FreeMIDI Driver included on the disc is provided as an additional module that allows the UM-4 to be used with FreeMIDI. In order to use it, FreeMIDI must already be installed on the start-up hard disk.

The UM-4 Driver included on the disc is provided as an additional module that allows the UM-4 to be used with FreeMIDI. In order to use it, FreeMIDI must already be installed on the start-up hard disk.

Turn on the power of the computer to start up your Macintosh. Use a USB cable to connect the UM-4 to your computer (**P.11**).

The message shown in the diagram will appear. Click **[OK]**. Insert the UM Driver CD-ROM into your CD-ROM drive.



■ Installing the UM-4 Driver



When Using S-MPU64

The UM-4 Driver is compatible with the S-MPU64. However, you cannot use the UM-4 Driver and the S-MPU64 Driver at the same time.

If you have already installed the S-MPU64 Driver in your computer, be sure to follow the procedure written below to delete the S-MPU64 Driver and install the UM-4 Driver.

Remove the files in the System folder written below and restart your Macintosh. Then install the UM-4 Driver.

- the “**USBSMPU64Driver**” file in the “**Extensions**” folder
- the “**SMPU64 Driver**” file in the “**FreeMIDI Folder**” folder

1

In the “**UM Driver E**” - “**UM-4**” folder of the CD-ROM, double-click the “**UM4 FreeMIDI Driver-E Installer**” icon to start up the installer.



UM4 FreeMIDI Driver-E Installer

2

Click **[Install]**. If the dialog box that all other currently-running applications will be exited appears, click **[Continue]**.

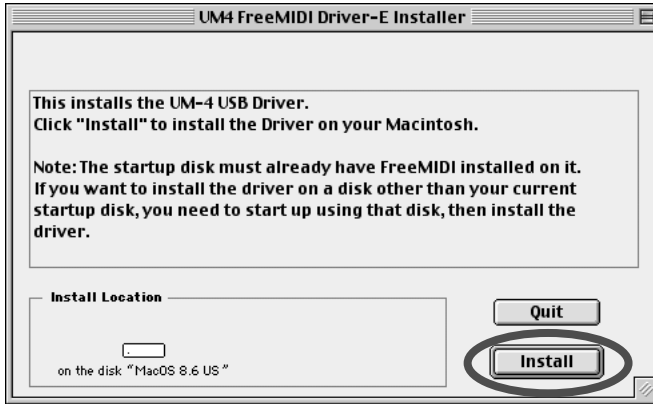

3

When installation is completed, click **[Restart]** to restart your computer.

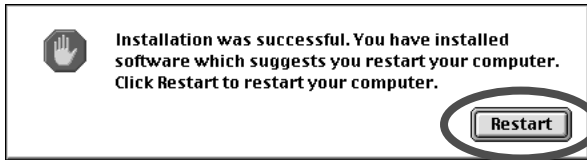

This completes installation of the UM-4 Driver.
Next you will make FreeMIDI settings.

■ FreeMIDI settings

1

Open the **“FreeMIDI Applications”** folder, and double-click the **“FreeMIDI Setup”** icon.



* There will be a version number following **“FreeMIDI Setup”** as the actual icon name.

2

The first time FreeMIDI is started up, a **“Welcome to FreeMIDI!”** dialog box will appear. Click **[Continue]**. If this is the second or later time, select **“FreeMIDI Preferences”** from the **File** menu.

3

In the **“FreeMIDI Preferences”** dialog box, check **“UM-4 Port”** which is located below UM-4 Driver in MIDI Configuration, and click **[OK]**.

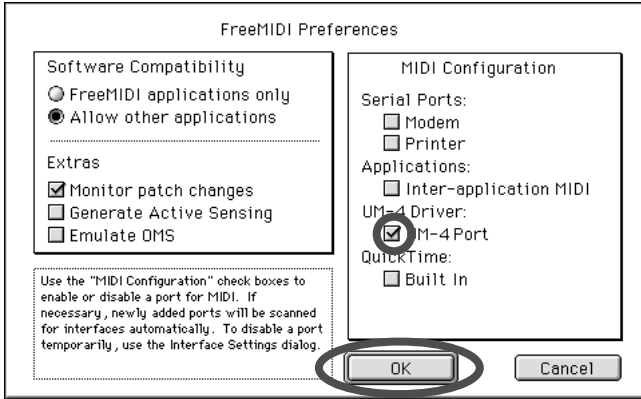

If the dialog box does not show **“UM-4 Driver,”** check whether the UM-4 is connected correctly, and start up FreeMIDI Setup once again.

4

The **About Quick Setup** dialog box will appear. Click **[Continue]**.

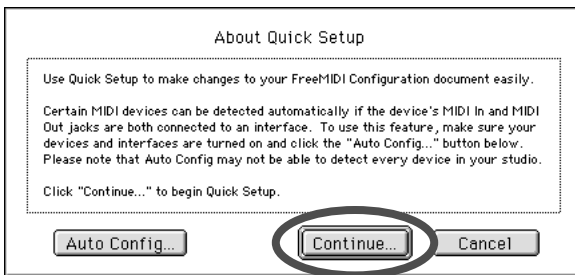

5

In the dialog box that appears, select the MIDI equipment that is connected to each port of the UM-4, and click [**>>Add>>**].

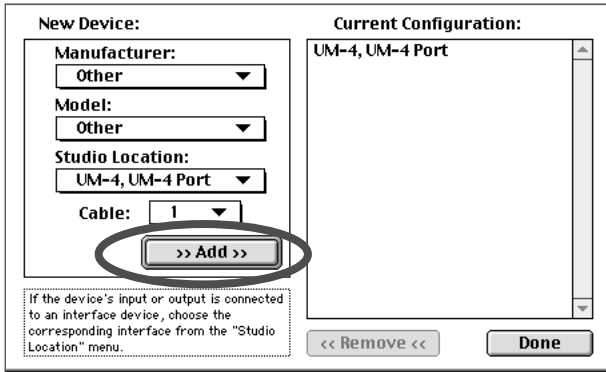

Manufacturer:

Select the manufacturer of your MIDI equipment. If the appropriate manufacturer does not appear in the list, select “Other.”

Model:

Select the model of your MIDI equipment. If the appropriate model does not appear in the list, select “Other.”

Studio Location:

Select “UM-4,” and for “Cable” that appears below it, select the port to which your MIDI equipment is connected.

6

If two or more units of MIDI equipment are connect, repeat step 5.

7

When settings are complete, click **[Done]**. A setting window like the following will appear.

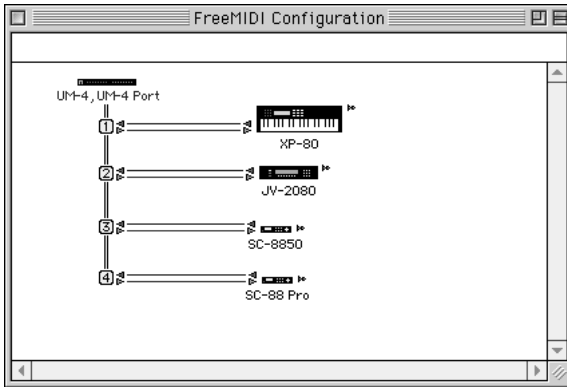

* This is one example of a setting window. The window that appears will depend on your setup.

8

If you selected “**Other**” for Model, double-click the appropriate icon in the setting window to make settings for your MIDI equipment. (For details refer to the documentation included with your software.)

9

From the **File** menu, select **[Save]**, and save your settings.

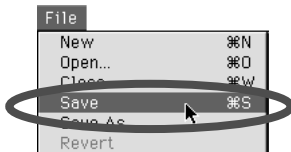

This completes driver settings.

Appendices

1. Connecting Equipment Supporting MTC

When connecting the UM-4 with equipment that supports MTC such as a hard disk recorder, refer to the illustration below, and connect to a port separate from the MIDI sound generator.

- * Refer to the manuals that came with your MTC-compatible device or MIDI sequencer for details about making the settings you need.

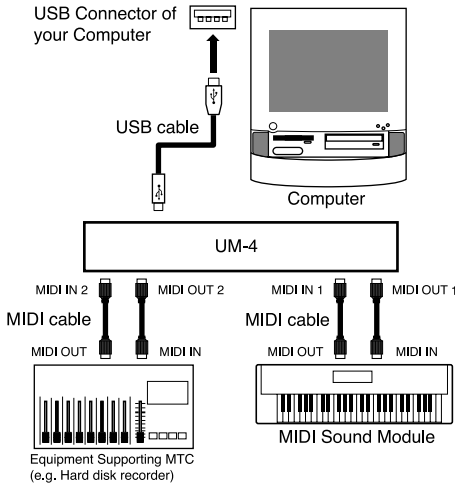

- * If you use a Macintosh, read "MTC settings for Macintosh users".

MTC settings for Macintosh users

■ OMS settings

1

Start up "OMS Setup," and double-click the MIDI device icon in the "My Studio Setup Window."

2

Check each item for MIDI Time Code, MIDI Beat Clock, and MIDI Machine Control, and click [OK].

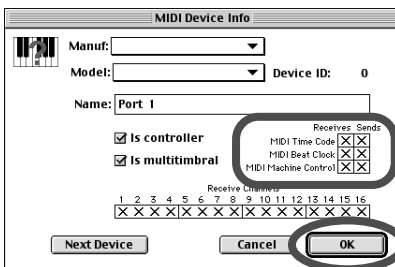

■ FreeMIDI settings

1

Start up “FreeMIDI Setup,” and double-click the MIDI device icon in “FreeMIDI Configuration.”

2

In the “FreeMIDI Device Specification” window, check all items in “Transmit Channels.”

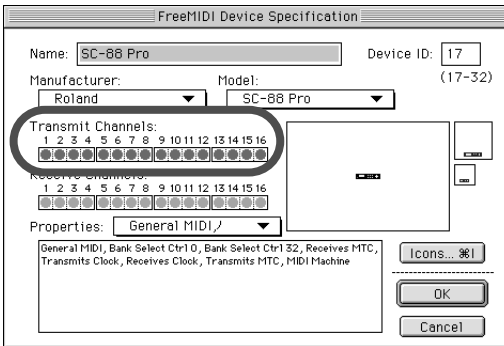

3

In “Properties,” check the 5 items enclosed by a frame in the illustration, and then click [OK].

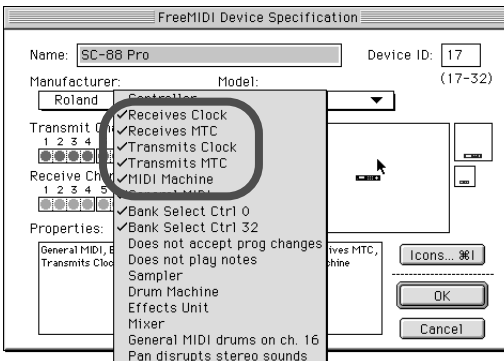

2. When Connecting Multiple UM-4 Units

Up to four UM-4 units can be used simultaneously.



Depending on the CPU processing speed, hard disk, memory, or application performance of your system, it may not be possible to use two or more units simultaneously.

■ Adding more USB Connectors

If your computer does not provide enough USB connectors, you will need a USB hub (a device to increase the number of USB connectors).

Please purchase a commercially available USB hub.

For connections to your computer, refer to the owner's manual for your USB hub.

■ Connecting Multiple UM-4 Units

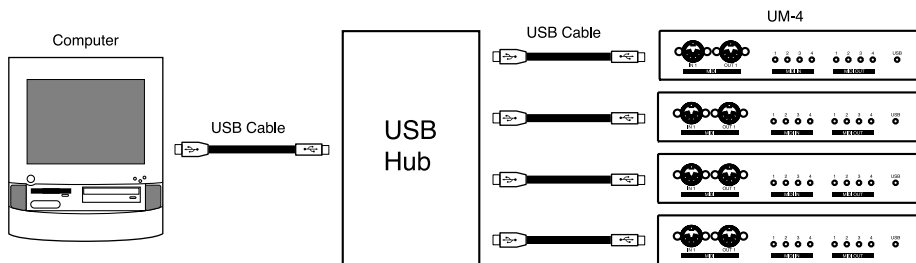

The UM-4 handles large amounts of data including MIDI messages via USB. If you are using two or more USB hubs, connect the UM-4 directly to the computer, or to the first USB hub.

■ Note of the Connecting Multiple UM-4 Units

When connecting multiple UM-4 units, the order of the MIDI device is assigned in the order (connection order) in which the computer recognized each UM-4 unit at the time of turning on the power of your computer or restarting the computer. Therefore, the order of the MIDI device may be changed when you restart the computer. In order to change the order of the MIDI device assigned to each UM-4, disconnect the USB cables connected to all UM-4 units (from the computer or USB hub). Then connect the UM-4 that you want to be the first unit to the USB connector that had been connected to the UM-4 previously recognized as the first unit. Make connections in the same way for the second and subsequent units.

■ Windows Users

If you use multiple UM-4 units, device numbers will be added to the beginning of the device name to indicate the order (connection order) in which the computer recognized each UM-4 unit.

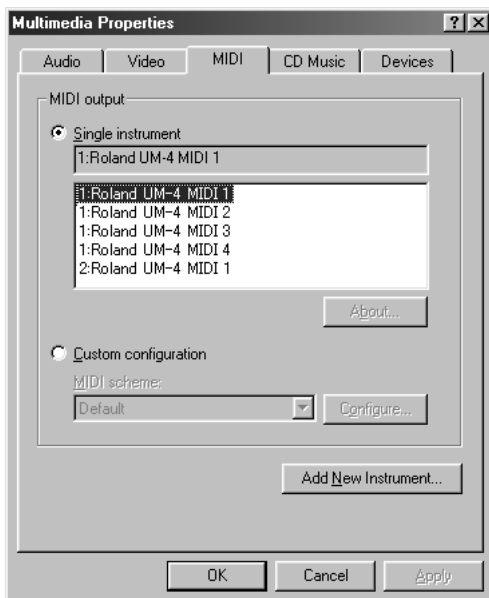

■ OMS Users on Macintosh

If you connect multiple UM-4 units and make OMS settings (P.24), multiple “Roland UM-4” items will appear in step 5 (P.26), as shown in the illustration. Simply click [OK], and follow the procedure to check all of the ports.

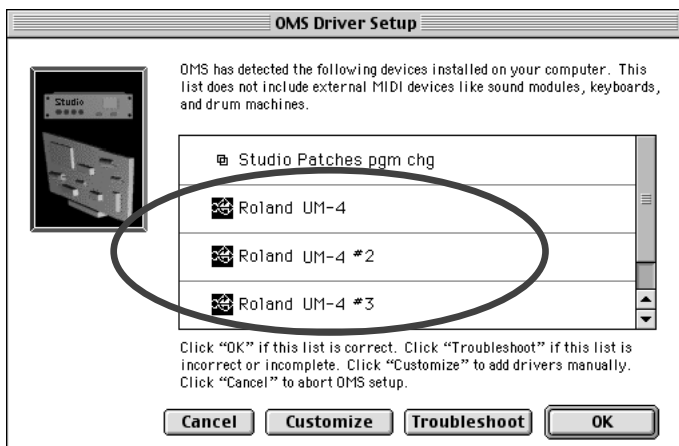

■ FreeMIDI Users on Macintosh

If you connect multiple UM-4 units and make FreeMIDI settings (P.30), multiple “**UM-4 Port**” items will appear in step 3 (P.31), as shown in the illustration. Check all of them, and click [OK]. Then follow the procedure to continue making settings.

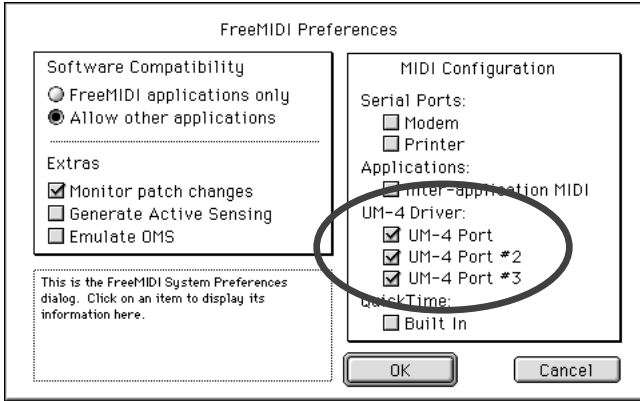

3. Deleting the USB MIDI Driver from Windows

1

From the Windows **Control Panel**, double-click the [**System**] icon.

2

Click the [**Device Manager**] tab.

**3**

Double-click [**Sound, video, and game controllers**] to access the list of devices.

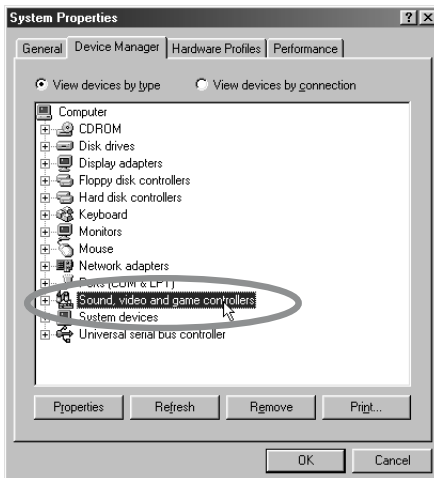

4

From the list, select **Roland UM-4 USB Driver** and click **[Remove]**.

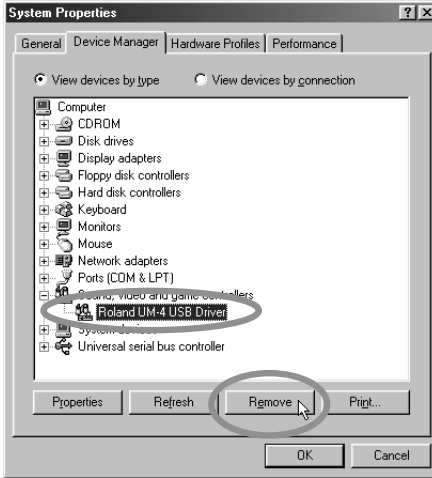

5

Make sure that **Roland UM-4 USB Driver** does not appear in the **[Sound, video, and game controllers]** list, and click **[Close]**.

6

Use the Windows Explorer etc. to remove the following files.

\\Windows\Inf\Other\Rolandrdif0004.inf
\\Windows\rdin0004.ini

- * With the default settings of Windows, Inf files will not be displayed. In order to remove this file, refer to the owner's manual for your computer or for Windows, and change the setting so that all files are displayed.

Troubleshooting

- * Please read the "Readme-E.txt" file in the UM Driver CD-ROM. You can get any additional information not written in the owner's manual from the "Readme-E.txt" file.

Windows Users → P.41

Macintosh Users → P.45

■ Windows users

Case 1: Cannot install the UM-4 Driver

◆ Is the USB cable connected correctly?

- Make sure that all USB cables you are using have been connected correctly.
- Disconnect the USB cables, and then re-connect them.

◆ Is USB enabled?

- Enable USB on your computer.

If an Unknown Device is not detected when you first connect the UM-4 to your computer via a USB cable, it is possible that the USB interface itself is disabled. Use the following procedure to check whether the USB interface is enabled.

1. Click the Windows **Start** button, and choose **Control panel** from **Settings**. In **Control panel**, double-click the **System** icon.
2. Click the **Device Manager** tab, and make sure that there are no yellow "!" marks or red "x" marks displayed beside **Universal serial bus controller** or the **USB Root Hub** below it.
If a yellow "!" mark or red "x" mark is displayed, the USB is currently disabled. Refer to the owner's manual for your computer, and enable the USB.

◆ Has an Unknown Device been registered?

- If while installing the UM-4 Driver, installation is halted for some problem such as a cable being pulled out, the UM-4 will be registered as an Unknown Device, and it may be impossible to perform the installation again. If this occurs, use the following procedure to Remove the Unknown Device, and install the driver once again.

1. Click the Windows **Start** button, and choose **Control panel** from **Settings**. In **Control panel**, double-click the **System** icon.
2. Click the **Device Manager** tab, and with **View devices by type** selected, make sure that there is no **Other devices**. If there is, double-click it, and if there are any **Unknown Devices** below it, click to select them and then click the **Remove** button to Remove them.
3. Disconnect the USB cable from the UM-4, and then re-connect the cable. If the computer recognizes the UM-4, perform the driver installation from the beginning.

◆ **Is a Roland USB-compatible product other than the UM-4 connected to your computer?**

→ If the UM-4 Driver is installed when a Roland USB-compatible device (UA-100 etc.) is connected to your computer, the UM-4 Driver may not be installed correctly. If you wish to simultaneously use both the UM-4 and another Roland USB-compatible device (such as the UA-100) on the same computer, you must disconnect the other USB-compatible device from the USB connector before installing the UM-4 Driver.

Case 2: USB connections cannot be made correctly

◆ **Has the UM-4 been recognized?**

→ Disconnect the USB cables, and then re-connect them.

→ It is possible that the computer has failed to recognize or initialize the UM-4. Leave the USB cable connected to the UM-4, and restart Windows. If connection still does not occur, exit Windows, and turn off the power of your computer. Then turn on the power of your computer and start Windows.

◆ **Are your computer or USB hub (*) supplying sufficient current?**

→ If insufficient current is being supplied to the UM-4, connection is not possible.

- Use a USB hub which contains its own power supply.
- The power conservation mode settings of your computer may be limiting the current supplied to the USB, so check these settings.

What is USB hub?

A “USB hub” is a device that expands the number of USB connectors. Broadly speaking, there are two types of USB hubs.

Self-powered hubs (USB hubs containing a power supply): The USB hub itself has an AC adapter, which supplies power (normally 500 mA) to the added USB connectors.

Bus-powered hubs (USB hubs not containing a power supply): The hub does not contain a power supply. The power supply of the connected computer is re-distributed to the added USB connectors.



For details on the electrical current that can be supplied by your computer or USB hub refer to the owner’s manual for your equipment. If you have questions, please contact the manufacturer or dealer for your computer or USB hub.



The UM-4 cannot be used with a hub that contains no power supply.



When a USB device is connected to a computer, the USB device tells the computer how much electrical current it uses. If this value exceeds the current that the computer is able to provide (maximum 500 mA), the device cannot be connected. The UM-4 will request 150 mA of current when it is connected to a computer. Most computers or self-powered USB hubs will have no problem with this current capacity. If you are using a dual-mode USB hub (self-powered / bus-powered), be sure to connect its power supply (AC adapter etc.) and use it as a self-powered USB hub.

Case 3: Cannot shift to Suspend (*)

◆ **Is an application which uses the UM-4 running?**

→ Exit the application which is using the UM-4.

The computer cannot shift to Suspend mode if an application such as a sequencer is using the UM-4.

What is Suspend?

This is a function which minimizes power consumption by shutting down the internal circuitry of the computer and the peripheral devices while the power remains supplied to the computer.

Case 4: UM-4 does not resume correctly from the suspended state

◆ **When suspended, was the UM-4 still connected via the USB cable?**

→ Disconnect the USB cable, and then re-connect it.

On some computers when Windows resumes from the suspended state, the UM-4 may fail to resume. If this occurs, the USB cable connected to the UM-4 should be disconnected and then reconnected.

Case 5: Windows hangs up (freezes) when returning from the suspended state

→ Disconnect the UM-4's USB cable before suspending.

On some computers when Windows resumes from the suspended state, it may hang up (freeze). If this occurs, the USB cable connected to the UM-4 should be disconnected before suspending.



If the computer itself has a suspend switch, the USB cable connected to the UM-4 should be disconnected before you press that switch.



For a notebook computer, some settings of the computer may cause it to automatically enter suspend mode when the lid (LCD display) is closed, so the USB cable connected to the UM-4 should be disconnected before the lid is closed.

When you once again wish to use the UM-4, make sure that the computer has resumed correctly from the suspend state, and then connect the USB cable to the UM-4.

Case 6: No sound

◆ **Are the USB cable, MIDI cables and audio cables connected correctly?**

→ Refer to "Connections" (P.11), and connect the cables correctly.

◆ **Are the volume controls of your sound module, audio system, and application raised?**

→ Check each of the volume controls.

◆ **Are the sound module settings correct?**

→ Set the Computer switch of your sound module to the "MIDI" position.



Before changing the setting of the computer switch of your MIDI sound module (SC-88Pro etc.), be sure to turn off the power.

Case 7: Does not work with Windows 95.

→ The UM-4 requires Windows 98. It will not operate on Windows 95.

Case 8: How can I rack-mount the UM-4?

→ Since the UM-4 is a one-space half-rack size, it can be mounted in a standard rack using the separately sold rack-mounting adapter (Roland RAD-50). When using the Roland RAD-50, do not attach the included rubber feet. Attach the UM-4 using the screws included with the Roland RAD-50.

Case 9: I used a USB cable to connect the UM-4 to my computer, and attempted to install it. However, the display indicates “Unknown Device” instead of “USB Compatible Device”.

→ If the display indicates “Unknown Device” instead of “USB Compatible Device” when you connect the UM-4 USB cable, the Windows item **[Start]-[Settings]-[Control panel]-[System]-[Device Manager]-[Universal serial bus controller]** will have a “USB Compatible Device” entry added to it. Select “USB Compatible Device”, press the Properties button to open **[USB Compatible Device Properties]**, and click “Update driver” after clicking **Device tab**. The window shown in “step 1” of P.15 will appear. Perform the installation as directed in the manual.

→ This problem can also occur if the USB waveform of your computer does not sufficiently meet the standards. In this case, the problem may be solved if you connect the UM-4 via a self-powered USB hub (USB hub containing a power supply).

Case 10: My computer hangs up when I open a MIDI file.

→ This problem can occur if the USB waveform of your computer does not sufficiently meet the standards. In this case, the problem may be solved if you connect the UM-4 via a USB hub (USB hub containing a power supply).

■ Macintosh users

Case 1: Cannot install the USB MIDI driver

◆ **Did you exit all other programs?**

→ Exit all currently-running programs.

Case 2: Cannot make USB connections correctly

◆ **Was the UM-4 recognized?**

→ Disconnect the USB cable, and then re-connect it.

→ If another USB device is connected, try connecting only the UM-4.

→ It is possible that the computer did not correctly recognize or initialize the UM-4. Leave the USB cable connected to the UM-4, and restart your Macintosh. If the connection is still not achieved, exit your Macintosh and turn off the power of the computer. Then turn on the power of the computer once again, and start up your Macintosh.

→ The computer cannot recognize the UM-4 when the USB connector of Macintosh's keyboard is used. Re-connect the USB cable to the USB connector of the main body.

◆ **Are your computer or USB hub (*) supplying sufficient current?**

→ If insufficient current is being supplied to the UM-4, connection is not possible.

- Use a USB hub which contains its own power supply.
- The power conservation mode settings of your computer may be limiting the current supplied to the USB, so check these settings.

What is USB hub?

A "USB hub" is a device that expands the number of USB connectors. Broadly speaking, there are two types of USB hubs.

Self-powered hubs (USB hubs containing a power supply): The USB hub itself has an AC adapter, which supplies power (normally 500 mA) to the added USB connectors.

Bus-powered hubs (USB hubs not containing a power supply): The hub does not contain a power supply. The power supply of the connected computer is re-distributed to the added USB connectors.



For details on the electrical current that can be supplied by your computer or USB hub refer to the owner's manual for your equipment. If you have questions, please contact the manufacturer or dealer for your computer or USB hub.



The UM-4 cannot be used with a hub that contains no power supply.



When a USB device is connected to a computer, the USB device tells the computer how much electrical current it uses. If this value exceeds the current that the computer is able to provide (maximum 500 mA), the device cannot be connected. The UM-4 will request 150 mA of current when it is connected to a computer. Most computers or self-powered USB hubs will have no problem with this current capacity. If you are using a dual-mode USB hub (self-powered / bus-powered), be sure to connect its power supply (AC adapter etc.) and use it as a self-powered USB hub.

Case 3: No sound

◆ **Are the USB cable, MIDI cables and audio cables connected correctly?**

→ Refer to "2. Connections with the MIDI Equipment" (P.12), and connect the cables correctly.

◆ **Are the volume controls of your sound module, audio system, and application raised?**

→ Check each of the volume controls.

◆ **Are the sound module settings correct?**

→ Set the Computer switch of your sound module to the "MIDI" position.



Before changing the setting of the computer switch of your MIDI sound module (SC-88Pro etc.), be sure to turn off the power.

◆ **Do you use only OMS?**

→ When using OMS on your Macintosh, it cannot operate correctly. When FreeMIDI is installed, delete the files related to FreeMIDI from the "Extensions" folder.

Case 4: Notes are sounded twice (Notes are recorded double)

→ Refer to the owner's manual for the sequencer program that you are using. If the "UM-4 Driver" is selected in the MIDI input port setting, cancel this selection (un-check it), and select (check) only the port (UM-4 Port 1-4) to which the MIDI device you wish to record is connected.

* When you select "UM-4 Driver," all of the four items "UM-4 Port1, 2, 3, 4" will be selected. However if "UM-4 Driver" and "UM-4 Port 1-4" are selected, the selected port will be sounded in duplicate.

Case 5: The UM-4 does not recover correctly from sleep mode.

→ After your Macintosh has been in sleep mode, exit the software and re-start it.

* We recommend that you make **Energy saving** settings in the **Control panel** so that your computer does not enter sleep mode.

Main Specifications

UM-4: 64 Channel USB MIDI Interface	
Connectors	MIDI Connectors (IN x 4, OUT x 4) USB Connector
Power Supply	Bus-powered (Supplied from Computer or USB Hub)
Current Draw	150 mA (during operation)
Dimensions	8-5/8 (W) x 3-15/16 (D) x 1-3/4 (H) inches 218 (W) x 99 (D) x 43 (H) mm
Weight	1 lbs 9 oz 0.7 kg
Accessories	UM-4 Driver CD-ROM USB Cable (2 m x 1) Rubber Feet x 4 Owner's Manual

* In the interest of product improvement, the specifications and/or appearance of this unit are subject to change without prior notice.

System requirements

The UM-4 and the USB MIDI drive require the following operating environment. Please make sure that each condition has been met.

■ Windows

Operating system	Microsoft® Windows® 98
Computer	Windows® 98 compatible computer with a USB connector conforming to USB Specification Version 1.0
CPU / clock	MMX® Pentium® processor / 166 MHz or better
Display resolution / colors	640 x 480 pixels or more / 256 colors or more
Memory	32 MB or more
Required hard disk capacity	1 MB or more

■ Macintosh

Operating system	Mac OS 8.5 or later
Computer	Apple Macintosh series having USB ports as the standard application
CPU / clock	PowerPC G3 / 233 MHz or better
Display resolution / colors	640 x 480 pixels or more / 32000 colors or more
Memory	64 MB or more
Required hard disk capacity	1 MB or more

* Although Roland has tested numerous configurations, and has determined that on average, a computer system similar to that described above will permit normal operation of the UM-4, Roland cannot guarantee that a given computer can be used satisfactorily with the UM-4 based solely on the fact that it meets the above requirements. This is because there are too many other variables that may influence the processing environment, including differences in motherboard design and the particular combination of other devices involved.

Information

When you need repair service, call your nearest EDIROL/Roland Service Center or authorized EDIROL/Roland distributor in your country as shown below.

EDIROL

EUROPE

EDIROL (Europe) Ltd.
Studio 3.4 114 Power Road
London W4 5PY
U. K.
TEL: +44 (0)20 8747 5949
FAX:+44 (0)20 8747 5948
http://www.edirol.com/europe

Deutschland
TEL: 0700 33 47 65 20

France
TEL: 0810 000 371

Italia
TEL: 02 93778329

Roland

NORTH AMERICA

CANADA

Roland Canada Music Ltd.
(Head Office)
5480 Parkwood Way Richmond
B. C., V6V 2M4 CANADA
TEL: (604) 270 6626

Roland Canada Music Ltd.
(Toronto Office)
170 Admiral Boulevard
Mississauga On L5T 2N6
CANADA
TEL: (905) 362 9707

U. S. A.

Roland Corporation U.S.
5100 S. Eastern Avenue
Los Angeles, CA 90040-2938,
U. S. A.
TEL: (323) 890 3700

AFRICA

EGYPT

Al Fanny Trading Office
9, EBN Hagar Al Asakalany
Street,
ARD El Golf, Heliopolis,
Cairo 11341, EGYPT
TEL: 20-2-417-1828

REUNION

Maison FO - YAM Marcel
25 Rue Jules Hermann,
Chaudron - BP79 97 491
Ste Clothilde Cedex,
REUNION ISLAND
TEL: (0262) 218-429

SOUTH AFRICA

Paul Bothner(PTY)Ltd.
Royal Cape Park, Unit 24
Londonderry Road, Ottery 7800
Cape Town, SOUTH AFRICA
TEL: (021) 799 4900

ASIA

CHINA

**Roland Shanghai Electronics
Co.,Ltd.**
5F, No.1500 Pingliang Road
Shanghai 200090, CHINA
TEL: (021) 5580-0800

**Roland Shanghai Electronics
Co.,Ltd.**

(BEIJING OFFICE)
10F, No.18 3 Section Anhuaxili
Chaoyang District Beijing
100011 CHINA
TEL: (010) 6426-5050

**Roland Shanghai Electronics
Co.,Ltd.**
(GUANGZHOU OFFICE)
2/F., No.30 Si You Nan Er Jie
Yi Xiang, Wu Yang Xin Cheng,
Guangzhou 510600, CHINA
TEL: (020) 8736-0428

HONG KONG

Parsons Music Ltd.
8th Floor, Railway Plaza, 39
Chatham Road South, T.S.T,
Kowloon, HONG KONG
TEL: 2333 1863

INDIA

Rivera Digitec (India) Pvt. Ltd.
409, Nirmam Kendra
Mahalaxmi Flats Compound
Off. Dr. Edwin Moses Road,
Mumbai-400011, INDIA
TEL: (022) 2493 9051

INDONESIA

PT Citra IntiRama
Jl. Cideng Timur No. 15J-150
Jakarta Pusat
INDONESIA
TEL: (021) 6324170

KOREA

Cosmos Corporation
1461-9, Seocho-Dong,
Seocho Ku, Seoul, KOREA
TEL: (02) 3486-8855

MALAYSIA/ SINGAPORE

Roland Asia Pacific Sdn. Bhd.
45-1, Block C2, Jalan PJU 1/39,
Dataran Prima, 47301 Petaling
Jaya, Selangor, MALAYSIA
TEL: (03) 7805-3263

PHILIPPINES

G.A. Yupangco & Co. Inc.
339 Gil J. Puyat Avenue
Makati, Metro Manila 1200,
PHILIPPINES
TEL: (02) 899 9801

TAIWAN

**ROLAND TAIWAN
ENTERPRISE CO., LTD.**
Room 5, 9fl. No. 112 Chung
Shan N.Road Sec.2, Taipei,
TAIWAN, R.O.C.
TEL: (02) 2561 3339

THAILAND

Theera Music Co., Ltd.
330 Soi Verng NakornKasem,
New Road, Sumpantawongse,
Bangkok 10100, THAILAND
TEL: (02) 224-8821

VIETNAM

**SAIGON MUSIC
DISTRIBUTOR
(TAN DINH MUSIC)**
138 Tran Quang Khai Street
Dist. 1, Ho Chi Minh City
VIETNAM
TEL: (08) 848-4068

AUSTRALIA/ NEW ZEALAND

AUSTRALIA/ NEW ZEALAND

**Roland Corporation
Australia Pty.,Ltd.**
38 Campbell Avenue
Dee Why West. NSW 2099
AUSTRALIA

For Australia
Tel: (02) 9982 8266
For New Zealand
Tel: (09) 3098 715

CENTRAL/LATIN AMERICA

ARGENTINA

Instrumentos Musicales S.A.
Av.Santa Fe 2055
(1123) Buenos Aires
ARGENTINA
TEL: (011) 4508-2700

BARBADOS

A&B Music Supplies LTD
12 Webster Industrial Park
Wildley, St.Michael, Barbados
TEL: (246)430-1100

BRAZIL

Roland Brasil Ltda.
Rua San Jose, 780 Sala B
Parque Industrial San Jose
Cotia - Sao Paulo - SP, BRAZIL
TEL: (011) 4615 5666

CHILE

Comercial Fancy II S.A.
Rut.: 96.919.420-1
Natanuel Cox #739, 4th Floor
Santiago - Centro, CHILE
TEL: (02) 688-9540

COLOMBIA

Centro Musical Ltda.
Cra 43 B No 25 A 41 Bodeoga 9
Medellin, Colombia
TEL: (574)3812529

CURACAO

Zeelandia Music Center Inc.
Orionweg 30
Curacao, Netherland Antilles
TEL:(305)5926866

DOMINICAN REPUBLIC

Instrumentos Fernando Giraldez
Calle Proyecto Central No.3
Ens.La Esperilla
Santo Domingo,
Dominican Republic
TEL:(809) 683 0305

ECUADOR

Mas Musica
Rumichaca 822 y Zaruma
Guayaquil - Ecuador
TEL:(593-4)2302364

GUATEMALA

Casa Instrumental
Calzada Roosevelt 34-01,zona 11
Ciudad de Guatemala
Guatemala
TEL:(502) 599-2888

HONDURAS

Almacen Pajaro Azul S.A. de C.V.
BO.Paz Barahona
3 Ave.11 Calle S.O
San Pedro Sula, Honduras
TEL: (504) 553-2029

MARTINIQUE

Musique & Son
Z.I.Les Mangle
97232 Le Lamantin
Martinique F.W.I.
TEL: 596 596 426860

Gigamusik SARI
10 Rte De La Folie
97200 Fort De France
Martinique F.W.I.
TEL: 596 596 715222

MEXICO

Casa Veerkamp, s.a. de c.v.
Av. Toluca No. 323, Col. Olivar
de los Padres 01780 Mexico
D.F. MEXICO
TEL: (55) 5668-6699

NICARAGUA

**Bansbach Instrumentos
Musicales Nicaragua**
Altamira D'Este Calle Principal
de la Farmacia 5ta.Avenida
1 Cuadra al Lago.#503
Managua, Nicaragua
TEL: (505)277-2557

PERU

Audionet
Distribuciones Musicales SAC
Juan Fanning 530
Miraflores
Lima - Peru
TEL: (511) 4461388

TRINIDAD

AMR Ltd
Ground Floor
Maritime Plaza
Barataria Trinidad W.I.
TEL: (868)638 6385

URUGUAY

Todo Musica S.A.
Francisco Acuna de Figueroa 1771
C.P.: 11.800
Montevideo, URUGUAY
TEL: (02) 924-2335

VENEZUELA

**Instrumentos Musicales
Allegro,C.A.**
Av.las industrias edf.Guitar
import
#7 zona Industrial de Turumo
Caracas, Venezuela
TEL: (212) 244-1122

EUROPE

AUSTRIA

**Roland Elektronische
Musikinstrumente HmbH.
Austrian Office**
Eduard-Bodem-Gasse 8,
A-6020 Innsbruck, AUSTRIA
TEL: (0512) 26 44 260

BELGIUM/FRANCE/ HOLLAND/ LUXEMBOURG

Roland Central Europe N.V.
Houtstraat 3, B-2260, Oevel
(Westerlo) BELGIUM
TEL: (014) 575811

CZECH REP.

K-AUDIO
Kardasovska 626.
CZ-198 00 Praha 9,
CZECH REP.
TEL: (2) 666 10529

DENMARK

Roland Scandinavia A/S
Nordhavnsvej 7, Postbox 880,
DK-2100 Copenhagen
DENMARK
TEL: 3916 2000

FINLAND

**Roland Scandinavia As, Filial
Finland**
Elannontie 5
FIN-01510 Vantaa, FINLAND
TEL: (09) 68 24 020

GERMANY

**Roland Elektronische
Musikinstrumente HmbH.**
Oststrasse 96, 22844
Norderstedt, GERMANY
TEL: (040) 52 60090

GREECE

STOLLAS S.A.
Music Sound Light
155, New National Road
Patras 26442, GREECE
TEL: 2610 435400

HUNGARY

Roland East Europe Ltd.
Warehouse Area 'DEPO' Pf.83
H-2046 Torokbalint,
HUNGARY
TEL: (23) 511011

IRELAND

Roland Ireland
G2 Calmount Park, Calmount
Avenue, Dublin 12
Republic of IRELAND
TEL: (01) 4294444

ITALY

Roland Italy S. p. A.
Viale delle Industrie 8,
20020 Arese, Milano, ITALY
TEL: (02) 937-78300

NORWAY

**Roland Scandinavia Avd.
Kontor Norge**
Lilleakerveien 2 Postboks 95
Lilleaker N-0216 Oslo
NORWAY
TEL: 2273 0074

POLAND

MX MUSIC SP.Z.O.O.
UL. Gibraltarska 4.
PL-03664 Warszawa POLAND
TEL: (022) 679 44 19

PORTUGAL

Roland Iberia, S.L.
Portugal Office
Cais das Pedras, 8/9-1 Dto
4050-465, Porto, PORTUGAL
TEL: 22 608 00 60

ROMANIA

FBS LINES
Piata Libertatii 1,
535500 Gheorgheni,
ROMANIA
TEL: (266) 364 609

RUSSIA

MuTek
Dorozhnaya ul.3,korp.6
117 545 Moscow, RUSSIA
TEL: (095) 981-4967

SPAIN

Roland Iberia, S.L.
Paseo Garcia Faria, 33-35
08005 Barcelona SPAIN
TEL: 93 493 91 00

SWEDEN

Roland Scandinavia A/S
SWEDISH SALES OFFICE
Danvik Center 28, 2 tr.
S-131 30 Nacka SWEDEN
TEL: (08) 702 00 20

SWITZERLAND

Roland (Switzerland) AG
Landstrasse 5, Postfach,
CH-4452 Itingen,
SWITZERLAND
TEL: (061) 927-8383

UKRAINE

TIC-TAC
Mira Str. 19/108
P.O. Box 180
295400 Munkachevo,
UKRAINE
TEL: (03131) 414-40

UNITED KINGDOM

Roland (U.K.) Ltd.
Atlantic Close, Swansea
Enterprise Park, SWANSEA
SA7 9FJ,
UNITED KINGDOM
TEL: (01792) 702701

MIDDLE EAST

BAHRAIN

Moon Stores
No.16, Bab Al Bahrain Avenue,
P.O.Box 247, Manama 304,
State of BAHRAIN
TEL: 17 211 005

CYPRUS

Radex Sound Equipment Ltd.
17, Diagonou Street, Nicosia,
CYPRUS
TEL: (022) 66-9426

IRAN

MOCO INC.
No.41 Nike St., Dr.Shariyati Ave.,
Roboeroy Cerah Mirdamad
Teheran, IRAN
TEL: (021) 285-4169

ISRAEL

**Halilit P. Greenspoon & Sons
Ltd.**
8 Retzif Ha'aliya Hashnya St.
Tel-Aviv-Yafo ISRAEL
TEL: (03) 6823666

JORDAN

**MUSIC HOUSE CO. LTD.
FREDDY FOR MUSIC**
P. O. Box 922846
Amman 11192 JORDAN
TEL: (06) 5692696

KUWAIT

**EASA HUSAIN AL-YOUSIFI
& SONS CO.**
Abdullah Salem Street,
Safat, KUWAIT
TEL: 243-6399

LEBANON

Chahine S.A.L.
Gerge Zeidan St., Chahine
Malatan House No.1
Al Noor Street, Ruwi
SULTANATE OF OMAN
TEL: 2478 3443

OMAN

TALENTZ CENTRE L.L.C.
Malatan House No.1
Al Noor Street, Ruwi
SULTANATE OF OMAN
TEL: 2478 3443

QATAR

Badie Studio & Stores
P.O. Box 62,
Doha, QATAR
TEL: 423554

SAUDI ARABIA

**aDawlah Universal
Electronics APL**
Corniche Road, Aldossary
Bldg., 1st Floor, Alkhorbar,
SAUDI ARABIA

**P.O.Box 2154, Alkhorbar 31952
SAUDI ARABIA
TEL: (03) 898 2081**

SYRIA

**Technical Light & Sound
Center**
Rawda, Abdul Qader Jazairi St.
Bldg. No. 21, P.O.BOX 13520,
Damascus, SYRIA
TEL: (011) 223-5384

TURKEY

ZUHAL DIS TICARET A.S.
Galip Dede Cad. No.37
Beyoglu - Istanbul / TURKEY
TEL: (0212) 249 85 10

U.A.E.

**Zak Electronics & Musical
Instruments Co. L.L.C.**
Zabeel Road, Al Sherooq Bldg.,
No. 14, Grand Floor, Dubai,
U.A.E.
TEL: (04) 3360715





