

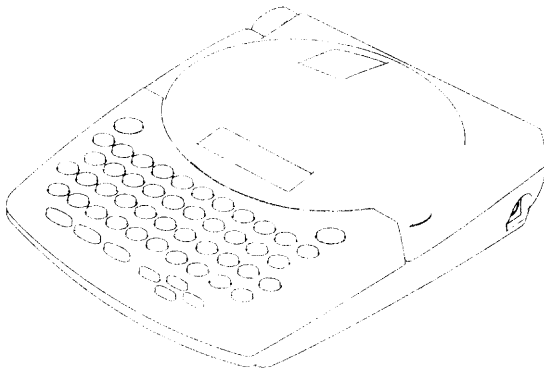

P-TOUCH EXTRA MODEL PT-330/350

USER'S GUIDE

- Read this User's Guide before you start using your P-Touch.
- Keep this User's Guide in a handy place for future reference.



brother®

INTRODUCTION

Thank you for purchasing the P-Touch 330/350!

Your new P-Touch will allow you to design and create labels and stamps for any application. Its versatility enables you to create custom labels by choosing from different frame designs, and character sizes and styles. In addition, the five tape widths (1/4" (6 mm), 3/8" (9 mm), 1/2" (12 mm), 3/4" (18 mm) and 1" (24 mm)) and variety of tape colors allow you to print personalized labels, useful for color-coded filing. With the Stamp function, you can quickly and easily make stamps for reusable pre-inked stamp holders.

You no longer have to worry about urgent tasks that require professional printing. In the office, the factory, the lab and the home, the quality and performance of the P-Touch 330/350 makes it an extremely practical machine.

Finally, as you may want to refer to this User's Guide occasionally, we suggest that you keep it in a handy place.

FCC NOTICE

This equipment has been tested and found to comply with the limits for a Class B digital device, pursuant to Part 15 of the FCC Rules. These limits are designed to provide reasonable protection against harmful interference in a residential installation. This equipment generates, uses, and can radiate radio frequency energy and, if not installed and used in accordance with the instructions, may cause harmful interference to radio communications. However, there is no guarantee that interference will not occur in a particular installation. If this equipment does cause harmful interference to radio or television reception, which can be determined by turning the equipment off and on, the user is encouraged to try to correct the interference by one or more of the following measures:

- Reorient or relocate the receiving antenna**
- Increase the separation between the equipment and receiver.**
- Connect the equipment into an outlet on a circuit different from that to which the receiver is connected.**
- Consult the dealer or an experienced radio/television technician for help.**

Patent numbers and patent publication numbers which are related to this product are as below:

USP4839742	USP4983058	USP5120147
USP4927278	USP5009530	
USP4976558	USP5069557	

CONTENTS

Getting Started

GENERAL DESCRIPTION	2
GENERAL PRECAUTIONS	4
BATTERIES	5
OPTIONAL AC ADAPTOR	6
TAPE CASSETTE	7
ATTACHING LABELS	8
PRINT HEAD & ROLLERS	9

Learning the Ropes

DOOR LABEL EXAMPLE	12
ADDRESS LABEL EXAMPLE	15
VIDEO CASSETTE LABEL	21

For Your Information

POWER KEY	28
CURSOR KEYS	29
CODE, ALT & SHIFT KEYS	31
SPACE KEY	34
RETURN KEY	35
NEW BLOCK FUNCTION	38
DELETE KEY	39
LINE OUT FUNCTION	42
CLEAR FUNCTION	43
COMPOSITE CHARACTER KEYS	44
ACCENT FUNCTION	46
SYMBOL FUNCTION	48
LENGTH FUNCTION	50
STAMP FUNCTION	53
SIZE & WIDE FUNCTIONS	56
STYLE FUNCTION	59
UNDERLINE FUNCTION	63
FONT FUNCTION	64
FRAME FUNCTION	67
TAPE FUNCTION	69
HORIZONTAL ALIGNMENT FUNCTION	71
VERTICAL PRINTING FUNCTION	72
MIRROR PRINTING FUNCTION	73
BAR CODE FUNCTION	74
PRINT KEY & FEED FUNCTION	77
NUMBERING FUNCTION	78
REPEAT PRINTING FUNCTION	81
CALENDAR FUNCTION	83
MEMORY FUNCTIONS	85
TROUBLESHOOTING	88
ERROR MESSAGE LIST	89
SPECIFICATIONS	94
ACCESSORIES	95

Getting Started



GENERAL DESCRIPTION

TOP VIEW

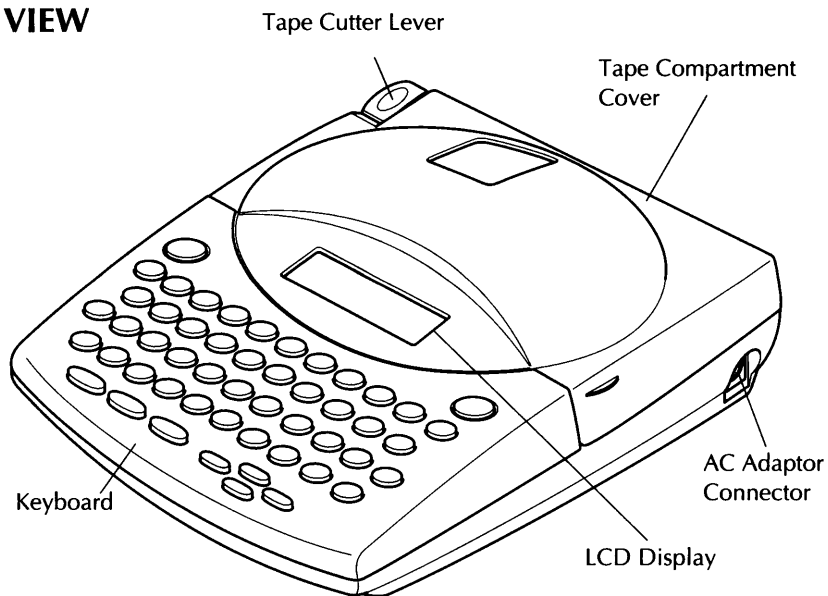

BOTTOM VIEW

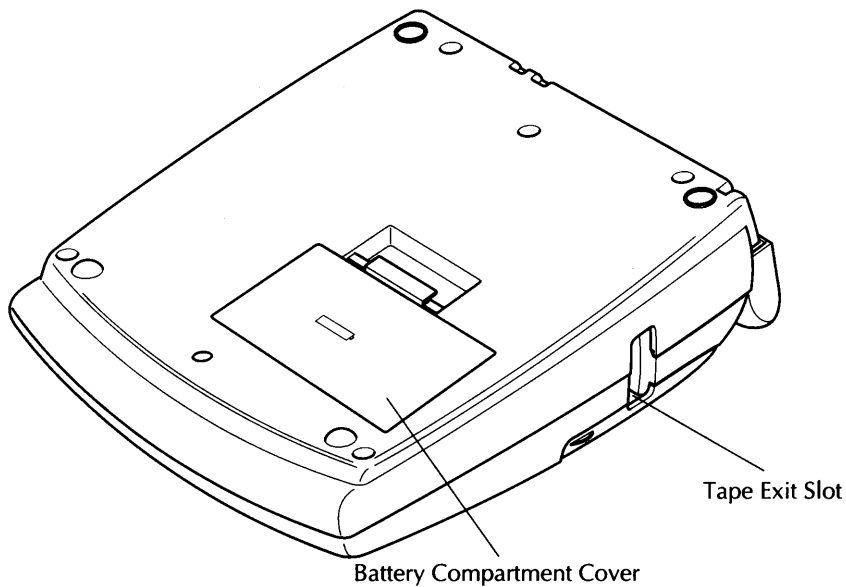

KEYBOARD & LCD DISPLAY

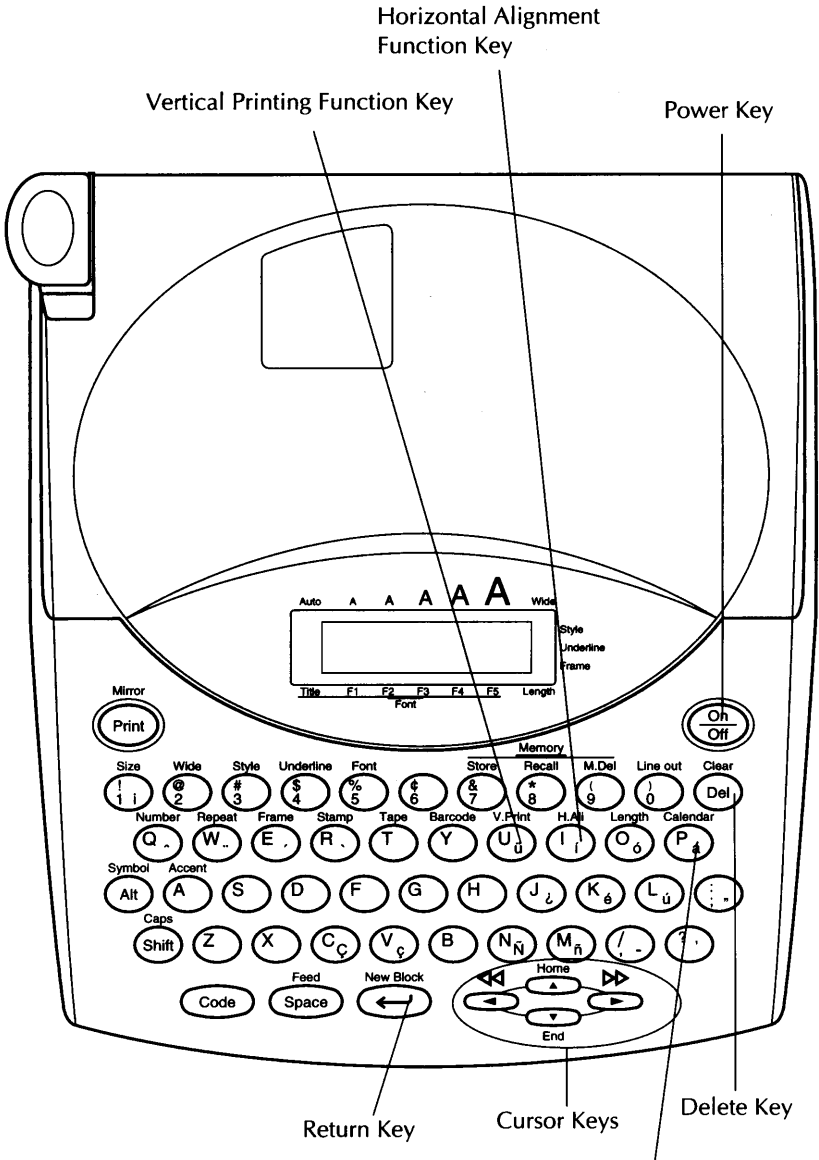

Only the P-Touch 350 is installed with the Calendar function.

GENERAL PRECAUTIONS

- Use only Brother TZ tapes with this machine. Do not use tapes that do not have the  mark.
- Do not pull on the tape being fed from the P-Touch. This may damage the tape cassette.
- Avoid using the machine in extremely dusty places. Keep it out of both direct sunlight and rain.
- Do not expose the machine to high temperatures or high humidity. Never leave it on the dashboard or in the back of your car.
- Do not leave any rubber or vinyl on the machine for an extended period of time. Doing so may cause staining.
- Do not clean the machine with alcohol or other organic solvents. Use a soft, dry cloth only.
- Do not put any foreign objects onto or into the machine.
- To avoid injuries, do not touch the cutter's edge.
- When inserting new batteries, be sure to do so within five minutes of removing the old ones, otherwise all text files will be lost (unless the machine is plugged into an AC outlet with the AC adaptor).
- Use only the AC adaptor (model AD-60) designed exclusively for this machine. Use of any other adaptor will void the warranty.
- Do not try to disassemble the AC adaptor.
- When the machine is not being used for a long period of time and it is not necessary to keep the text files stored in the memory, disconnect the AC adaptor, and remove the batteries to prevent them from leaking and damaging the machine.
- When the AC adaptor is plugged into the machine, unplugging the adaptor from the AC outlet can delete all text files in the memory, even though batteries are installed.
- **Use six AA alkaline batteries in this machine.**

BATTERIES

This lightweight and portable machine can be used anywhere by installing six (6) **AA alkaline batteries**. When you change the batteries, always replace all six at the same time.

To change the batteries:

- 1 Remove the battery compartment cover on the back of the machine.
 - 2 If batteries are already installed, remove them.
 - 3 Insert six new AA alkaline batteries, making sure that they face the correct direction.
 - 4 Attach the battery compartment cover.
-  *Be sure to insert the new batteries within five minutes of removing the old ones, otherwise the text shown in the display and any text files stored in the memory will be lost (unless the machine is plugged into an AC outlet with the AC adaptor).*

Remove the batteries and disconnect the AC adaptor if you do not intend to use this machine for an extended period of time. When the power is disconnected, all text shown in the display and stored in the memory will be lost.

If alkaline batteries are not used, large fonts and bar codes cannot be printed.

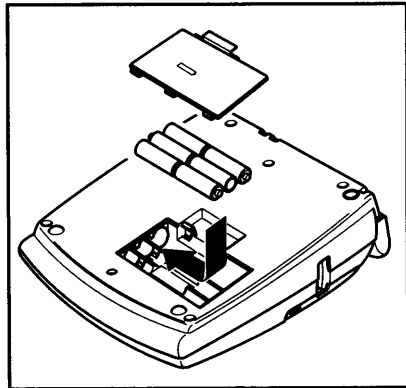
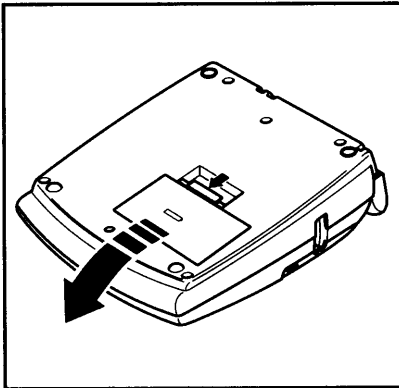

OPTIONAL AC ADAPTOR

The AC adaptor (model AD-60) allows you to use this machine wherever there is an electrical outlet.

To connect the optional AC adaptor:

- 1 Insert the plug on the adaptor cord into the connector marked DC IN 9.5V on the right side of the machine.
 - 2 Insert the plug on the adaptor into the nearest standard electrical outlet.
-  *Only use the AC adaptor designed exclusively for this machine.*

Remove the batteries and disconnect the AC adaptor if you do not intend to use this machine for an extended period of time. When the power is disconnected, all text shown in the display and stored in the memory will be lost.

It is recommended that you use the AC adaptor when printing large fonts and bar codes on 3/4" (18-mm)- or 1" (24-mm)-wide tape since these operations can quickly drain the batteries.

When making a large stamp, use an AC Adapter (model AD-60). Creating a large stamp while using batteries may cause poor stamp quality.

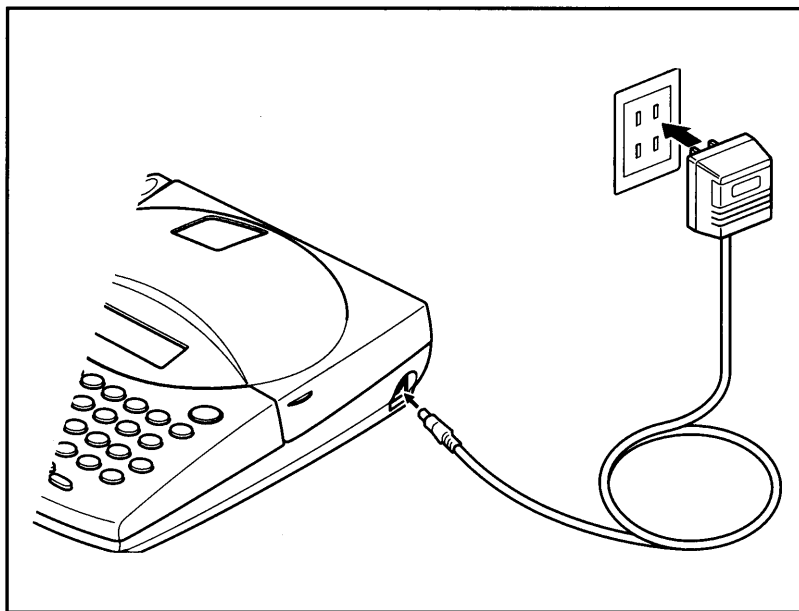

TAPE CASSETTE

A single TZ tape cassette is supplied with this unit. However, since TZ tape cassettes are available for this machine in a wide variety of colors and sizes, it is possible to make distinctive color-coded and stylized labels.

In addition, this machine has been designed to allow you to change the tape cassettes quickly and easily.

To change the tape cassette:



- 1 Lift open the tape compartment cover. The installed cassette is also released.
- 2 If a tape cassette is already installed, remove it by pulling it straight up.
- 3 Remove the stopper from a new tape cassette.

 *Make sure that the end of the tape feeds under the tape guides.*

If the ink ribbon in the cassette is loose, use your finger to wind the toothed wheel in the direction of the arrow on the tape cassette until the ribbon is taut. If you are using an old tape cassette, be sure the ribbon is taut before inserting it into the unit.

- 4 Insert the tape cassette firmly into the tape compartment, making sure that the entire back of the cassette contacts the bottom of the compartment.

 *When inserting the tape cassette, make sure that the inner ribbon does not catch on the corner of the metal guide.*

- 5 Close the compartment cover, then turn on the machine if it is off.
- 6 Hold down  and press  once to advance the tape and remove any slack.
- 7 Push down on the tape cutter lever to cut off the excess tape.

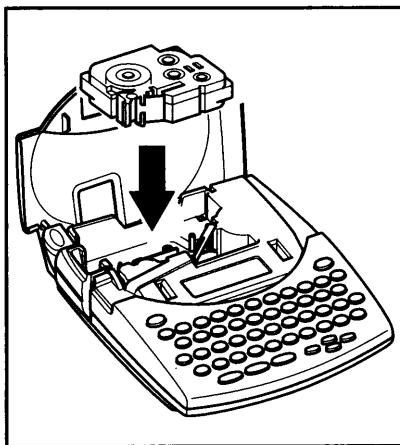
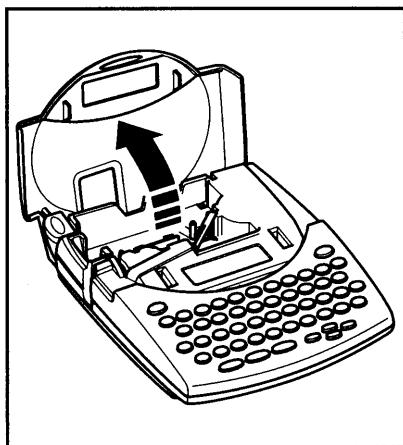

ATTACHING LABELS

LAMINATED TAPE

The enclosed stick enables you to easily remove the backing from labels printed on laminated tapes.

- 1 Hold the tape in your left hand, with the printed surface facing up, and hold the stick in your right hand.
- 2 Pass the tape halfway through the long narrow hole in the stick.
- 3 Turn the stick one quarter of a turn towards you and pull the stick away from you as shown below.
- 4 Peel off the label backing.

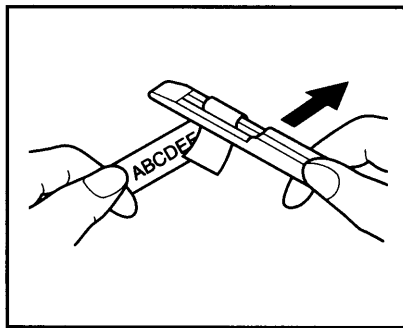
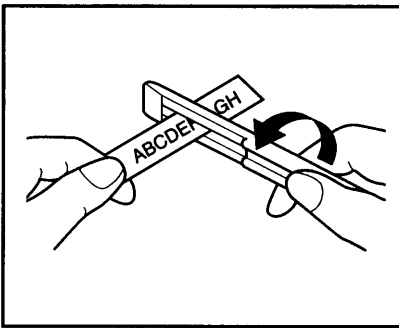

FABRIC TAPE

Fabric tape is used to attach a piece of fabric printed with your text onto garments using an iron. After printing the text onto fabric tape and cutting off the label using scissors, place the label on an ironed garment at the location where you wish to attach it in such a way that the printed text can be read correctly. Cover the label with another piece of cloth and use an iron set to a medium-high temperature (160 to 180 °C) to press down firmly for 10 to 15 seconds. For more details, refer to the instructions included with the fabric tape cassette.

STAMP TAPE

Refer to pages 53 through 55 for a detailed explanation on using the stamp tape to make stamps.

PRINT HEAD & ROLLERS

Occasionally, specks of dust or dirt become attached to the machine's print head and rollers. This is particularly likely when you are using the unit outdoors or in a very dusty environment. If a section of the print head is covered with dust, a blank horizontal streak may appear through the label text.

Therefore, as with a tape recorder, the machine's head may need to be cleaned from time to time.

To clean the print head and rollers:

- 1 Turn off the machine.
- 2 Open the tape compartment cover, then remove the tape cassette if one is installed. The print head and rollers are located in the tape compartment.
- 3 **Print head:** Use a dry cotton swab to gently wipe the print head with an up-and-down motion.
Rollers: Use a dry cotton swab to wipe each roller with an up-and-down motion while rotating them with your finger.
- 4 Try printing again.

If dust still remains:

- 5 Repeat step 3 using a cotton swab dipped in isopropyl (rubbing) alcohol.

If none of the above works, contact your service representative.

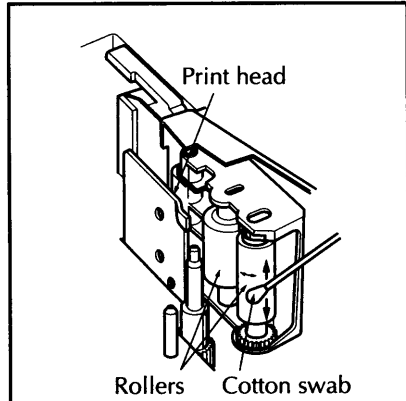
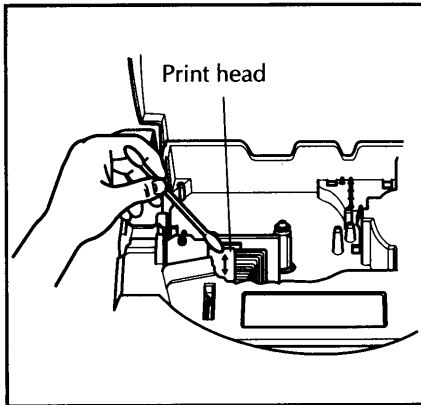

*Learning
the Ropes*

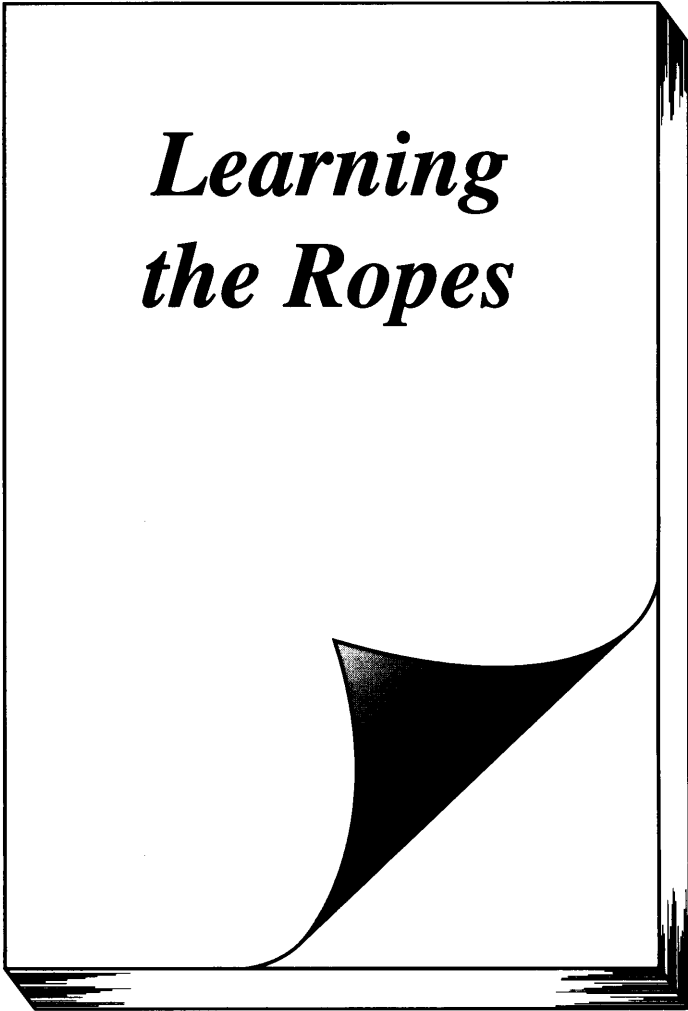

DOOR LABEL EXAMPLE



After you have inserted the batteries and the enclosed tape cassette as explained in the previous section, let's practice using some of the basic functions of your P-Touch 330/350. We must first begin by turning on the power to the machine.

To turn on the machine:

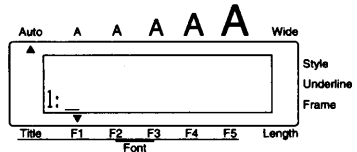
- 1 Press  in the top right-hand corner of the keyboard.



The underline in the LCD display is called the "cursor". It is like a pointer which shows your current position and lets you select characters in your text.

The text you create may sometimes be longer than the 11 characters that the LCD display can show at one time. Therefore, the cursor can be moved to show other parts of the text. Pressing the left cursor key () moves the cursor to left so that the left side of the text can be seen and pressing the right cursor key () moves the cursor to the right so that the right side of the text can be seen.

Some format settings are shown by the triangles and squares above and below the display. The default settings (the selected settings when the power is turned on for the very first time) have been pre-programmed into the machine and represent the most common settings for labels. However, you can design your own label to have any format that you wish. Detailed explanations of the formats can be found on pages 56 through 73.

Now, let's enter the text for our first example, the simple door label shown below.



MEETING ROOM

 The label in this example was made using the enclosed 1/2" (12-mm)-wide tape.

ENTERING THE TEXT

Since all of the text will be in capital letters, we will use the Caps mode, which allows us to type capital letters continuously without holding down .





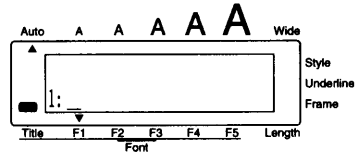

To enter Caps mode:

- ② Hold down  and press  once. The Caps indicator on the left side of the display lights up.





Then, let's type in the text in the same way that you would type on a typewriter or a computer keyboard.

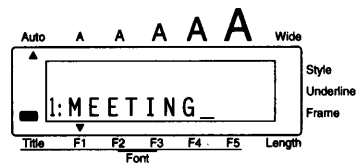

To type in "MEETING":

- ③ Press  once and  twice, then press , ,  and  once each.

 All letters are automatically entered as capital letters.



Also like on a typewriter or computer keyboard, the space key () allows you to add blank spaces to the text.

 The space key () is different from the right cursor key () , which moves the cursor through the entered text without adding blank spaces.

To add a space:

- ④ Press .

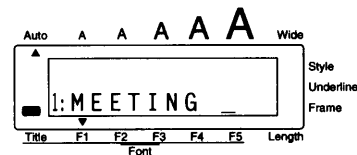

Type the second word, "ROOM", to finish the text.

To type in "ROOM":

- 5 Press ^{Stamp} (R) once, ^{Length} (C) twice, then ^{M_n} once.

Since the text is longer than the LCD display, "ME" moves off the display to the left.

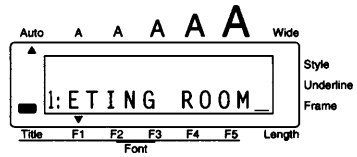

Now that we are finished entering capital letters, we can exit Caps mode.

To exit Caps mode:

- 6 Hold down ^{Code} and press ^{Caps} (Shift) once. The Caps indicator goes off.

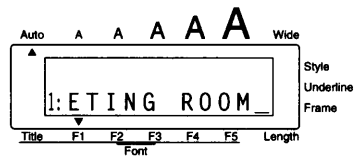

Once you have entered the text, you can easily edit it by correcting mistakes or simply adjusting it or its format. For detailed explanations of text editing methods, see pages 41 to 45.

PRINTING THE TEXT

Several format settings are available, however, in this example we will use the default settings pre-programmed into the machine and print out our label.

To print the door label:

- 7 Press ^{Mirror} (Print) once. The message "WORKING" appears just before printing begins, then "COPIES 1/1" appears while the label is being printed.

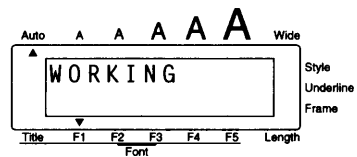

To cut off the door label:

- 8 Push down on the tape cutter lever.

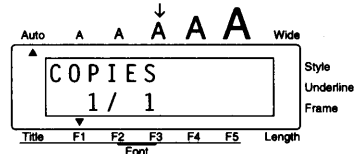

ADDRESS LABEL EXAMPLE

While making the multi-line address label in this example, we will learn how to create more decorative labels using the various format settings.

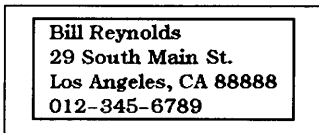

☞ Four-line labels, such as this address label, can only be printed on either 3/4" (18-mm)- or 1" (24-mm)-wide tape.

Before entering our new text, we must first erase the text from the previous time that the P-Touch was used.

To clear the display for a new label:

- 1 Hold down **Code** and press **Clear** (Del).

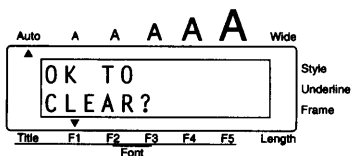



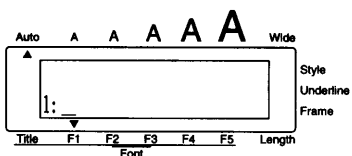

- 2 Press **New Block** (←).





ENTERING THE TEXT

Let's begin by typing in the first row of text, the name "Bill Reynolds".

To type in "Bill Reynolds":

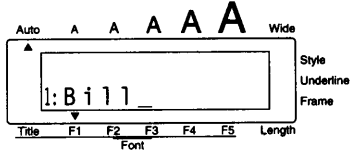
- 3 Hold down ^{Caps}  and press ^B  once, then release ^{Caps} . Press ^{H.Ali}  once, then ^{L_o}  twice.



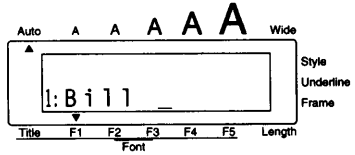

- 4 Press ^{Feed} .

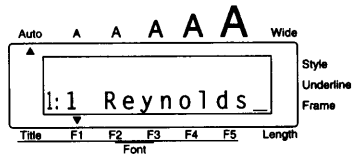

- 5 Type in "Reynolds".
Again the text is longer than the LCD display. So "Bill" moves off the display to the left.



In a multi-line label, the return key (^{New Block} ) is used to end one line and start the next one. The return mark () indicates the end of the line.

To end the first line and begin another one:

- 6 Press ^{New Block} .

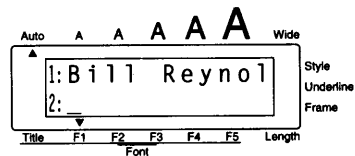

Now, we can enter the address and telephone number: 29 South Main St.; Los Angeles, CA 88888; 012-345-6789.

To type in the address:

- 7 Type "29 South Main St.", then press

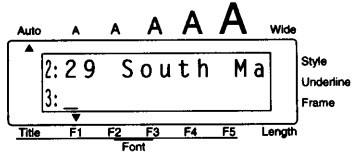

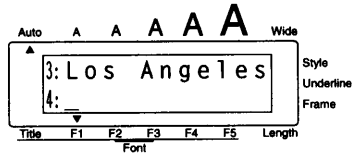

- 8 Type "Los Angeles, CA 88888", then press



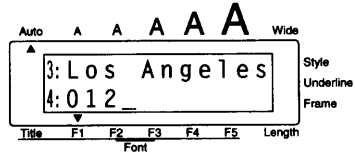

To type in the phone number:

- 9 Type "012".

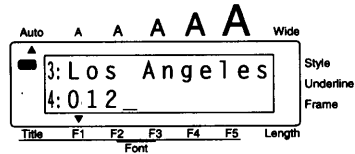

- 10 Hold down . The Alt indicator on the left side of the display lights up.



- 11 Keep  held down and press .

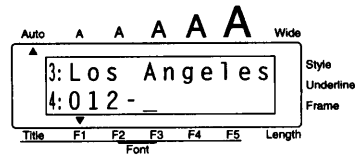

- 12 Finish the text by typing "345-6789".

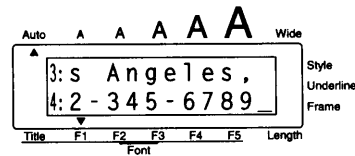

FORMATTING THE TEXT

Now the text is entered as we wish. If it were printed, the standard default settings would be used. The text would be aligned on the left side with 1" (25 mm) margins and would not be framed or underlined. In addition, the characters would be auto-sized (Auto) and printed using the HELSINKI Font (F1) and NORMAL Style settings. For more details concerning format settings, please see pages 56 and 73.

For this label, though, let's assume we want a different style of text: Brussels font (F2), framed with 1/3" (8 mm) margins. Therefore, we must change the format.

To select the BRUSSELS Font setting:

- 13 Hold down **Code** and press **Font**  once.

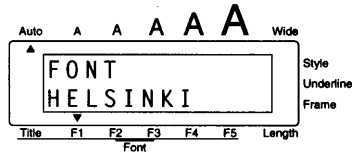

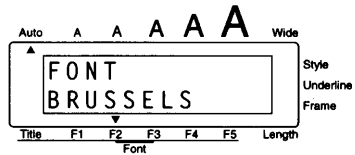

- 14 Keep **Code** held down and continue pressing **Font**  until BRUSSELS is displayed, then release **Code**.

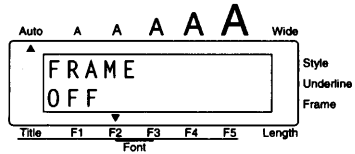

To select the SQUARE Frame setting:

- 15 Hold down **Code** and press **Frame**  once.



- 16 Keep **Code** held down and continue pressing **Frame**  until SQUARE is displayed, then release **Code**.

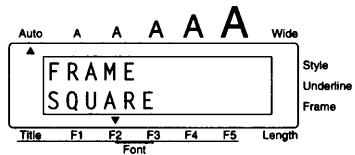

To select the ## Tape setting:

- 17 Hold down **Code** and press **Tape** once.

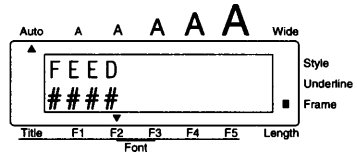

- 18 Keep **Code** held down and continue pressing **Tape** until ## is displayed, then release **Code**.

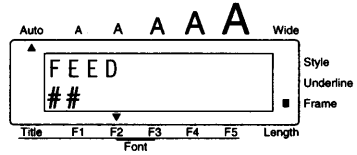

Different format settings can be chosen either before or after the text is entered. The procedure shown above can be used to change the other format settings.

PRINTING THE TEXT

If we want only one copy of the text, we could just press **Mirror** **Print** to print it. However, let's assume that we have three letters onto which we wish to attach address labels. Therefore, we need to print three copies of the same text.

To print three copies of the label:

- 19 Hold down **Code** and press **Repeat** once.

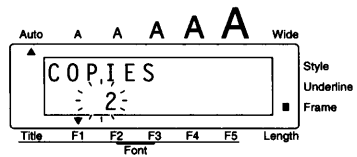

- 20 Press **Home** until setting 3 is displayed.

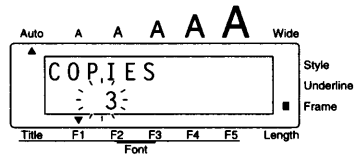

- 21 Press . The message "WORKING" appears just before printing begins, then the number of each copy is displayed while it is being printed.

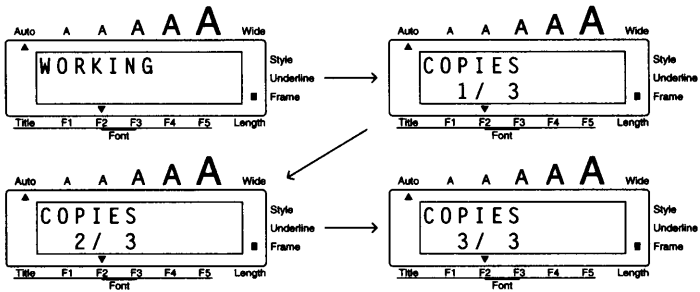

- 22 Push down on the tape cutter lever to cut the tape, then use scissors to cut along the printed dots to separate the labels.

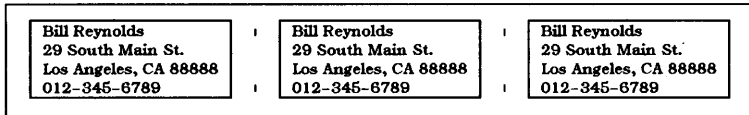

VIDEO CASSETTE LABEL



Now, we will design a label for a video cassette tape. This example will show how to make a more complex, multi-block label.



 The labels in this example were made using 3/4" (18-mm)-wide tape.

Before entering our new text, we must first erase the text from the previous time that the P-Touch was used.

To clear the display for a new label:

- Hold down  and press  once.
- Press .

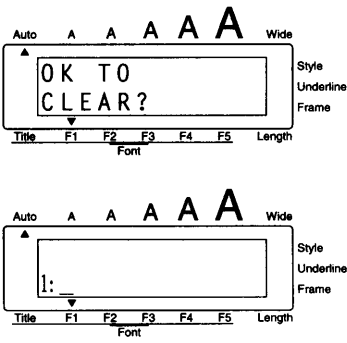

The diagram shows two states of a P-Touch display. The top display shows the text 'OK TO CLEAR?' in a simple font. Above the display are five font style options: 'Auto', 'A', 'A', 'A', 'A', and 'Wide'. To the right of the display are three style options: 'Style', 'Underline', and 'Frame'. Below the display are five function keys labeled 'Title', 'F1', 'F2', 'F3', 'F4', 'F5', and 'Length'. The bottom display shows a cursor at the beginning of a line, with a colon and a space ': ' visible. It has the same font style options above, style options to the right, and function keys below.

Each time the number of lines change, a new block of text must be created. Therefore, the text for our label must be entered in three separate blocks.

Since we will now change from a one-line to a two-line block, we will use the New Block function instead of a normal return. The new block mark () indicates the end of a block. For more details about the New Block function, refer to *NEW BLOCK FUNCTION* on page 38.

To enter the remaining text:

- 7 Hold down **Code** and press  once.

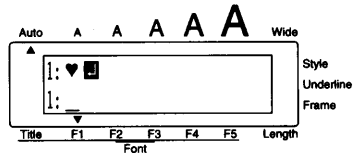

- 8 Hold down **Code** and press **Caps Shift** once to enter Caps mode.

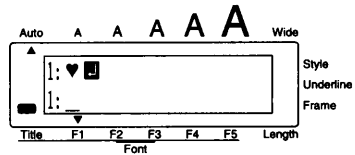

- 9 Type "FAVORITE MOVIES", then press  .

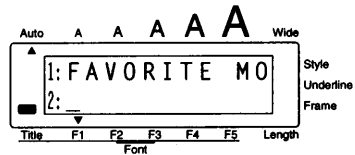

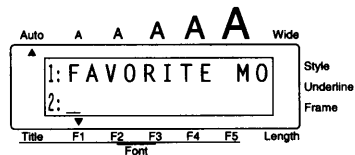

- 20 Hold down **Code** and press **Caps Shift** once to exit Caps mode.

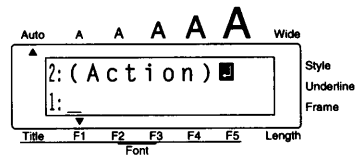

- 21 Type "(Action)".

- 22 Hold down **Code** and press  once.



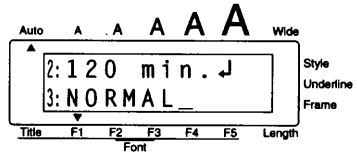

- 23 Type "Tape 1", "120 min.", and then "NORMAL", pressing  after each line except the last.





FORMATTING THE TEXT

Now that we've entered all of the text, we can start formatting it. Since we want to make a label for a video cassette, we can use the Length function to select the exact label length for a VHS video cassette. By keeping the AUTO Size setting, the size of our characters will adjust to fit within the selected label length. However, we will change the style of the characters to make them more decorative.

To select the VCR VHS Length setting:

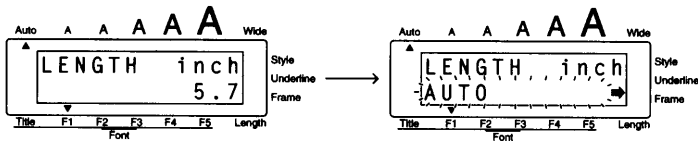
- 24 Hold down  and press  once. The length of the entered text briefly appears on the display.



- 25 Press  to select VCR VHS.

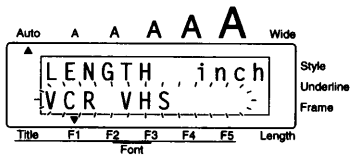

- 26 Press .

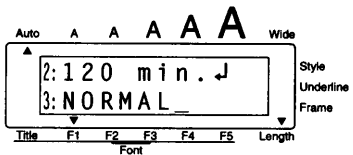

To select the SOLID Style setting:

- 27 Hold down **Code** and press **Style** once.

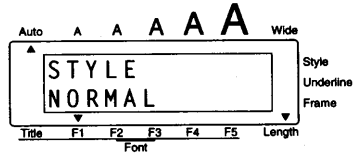

- 28 Keep **Code** held down and continue pressing **Style** until SOLID is displayed, then release **Code**.

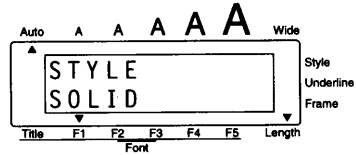

PRINTING THE TEXT

These labels are printed on 3/4" (18-mm)-wide tape.

If we have two video cassettes containing our favorite action movies, we can use the Numbering function to print two copies of our text while automatically increasing the tape number. Before we can print using the Numbering function, we must first select the numbering field.

To use the Numbering function:

- 29 Press **Left Arrow** and **Home** to position the cursor below the "1" of "Tape 1".

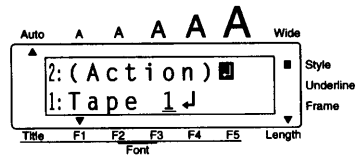

- 30 Hold down **Code** and press **Number**.

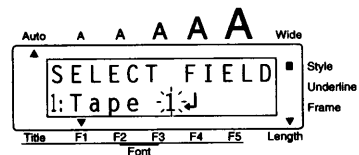

- 31 Since we only want one character in the numbering field, press  .

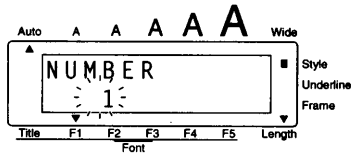

- 32 Press  until setting 2 is displayed.

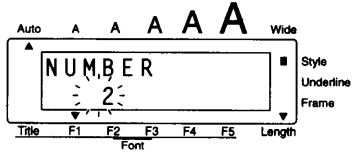

- 33 Press  to begin printing the labels.

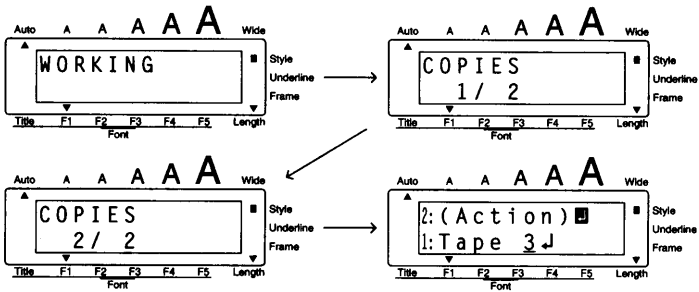

- 34 Push down on the tape cutter lever to cut the tape, then use scissors to cut along the printed dots to make two separate video cassette labels.

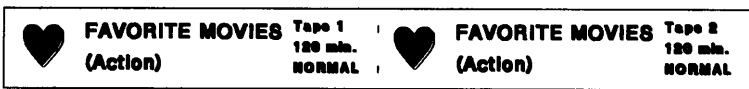

With these three examples, we have covered many of the basic features of your PT-330/350 so that you can begin creating your own customized labels. If you have any questions about any of the functions or keys, refer to the appropriate explanation in the following section.

***For Your
Information***

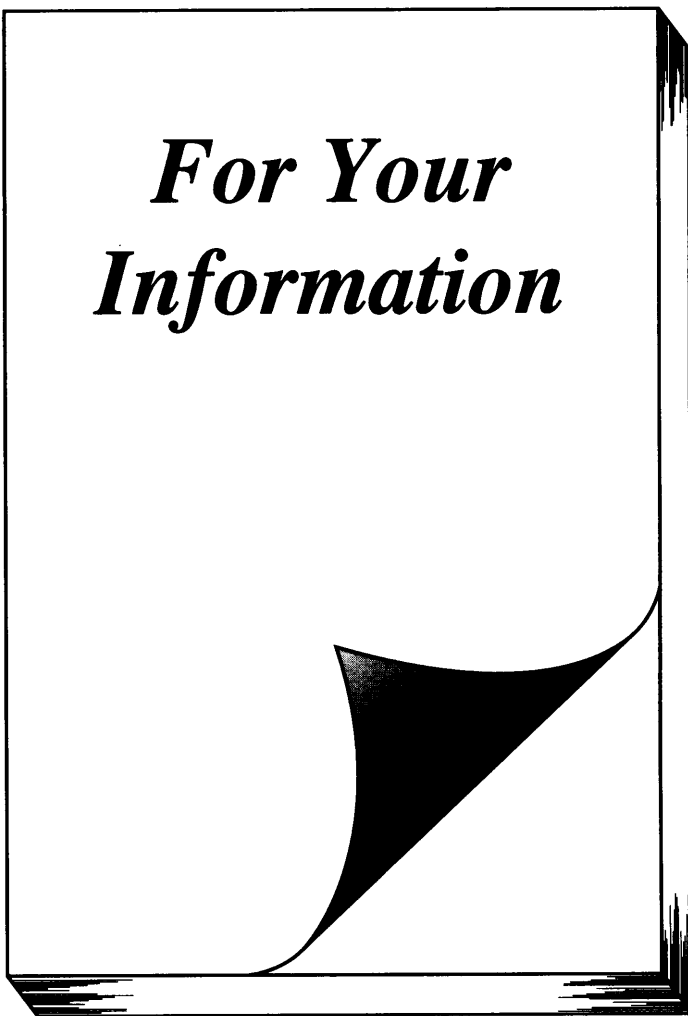

POWER KEY

The power key () is located in the top right-hand corner of the keyboard. If batteries have been installed or the machine has been plugged in using the optional AC adaptor, the previous session's information is displayed when the machine is turned on. This feature allows you to stop work on a label, turn off the machine, and return to it later without having to re-enter the text.

The machine will automatically turn off if no key is pressed within 5 minutes. The machine's internal memory stores the current session's information and displays it when you turn on the machine again.

To turn on the machine:

- Press . The previous session's information appears in the LCD display.

To turn off the machine:

- Press . The current session's information is stored in the internal memory.

CURSOR KEYS

The machine's LCD display shows two rows of 11 characters; however, the text that you create can be up to 255 characters long. You can review and edit your text by using the cursor keys to move the cursor so that different parts are shown in the display.

LEFT CURSOR KEY



To move the cursor one character to the left:

- Press  once.



To move the cursor several characters to the left:

- Hold down  until the cursor moves to the desired position.

To move the cursor to the beginning of the current line:

- Hold down  and press .

To move the cursor to the beginning of the current text block:

- Hold down  and press .

 *If the cursor is at the beginning of a text block, it will move to the beginning of the previous block.*

RIGHT CURSOR KEY

To move the cursor one character to the right:

- Press  once.



To move the cursor several characters to the right:

- Hold down  until the cursor moves to the desired position.

To move the cursor to the end of the current line:

- Hold down  and press .

To move the cursor to the beginning of the following text block:

- Hold down  and press .

 *If the cursor is in the last text block, it will move to the end of the text.*

UP CURSOR KEY

To move the cursor up to the previous line:

- Press  once.

 *If the cursor is in the first line of text, it will move to the beginning of the line.*

To move the cursor up several lines:

- Hold down  until the cursor moves to the desired position.

To move the cursor to the beginning of the entire text:

- Hold down  and press .

DOWN CURSOR KEY

To move the cursor down to the following line:

- Press  once.

 *If the cursor is in the last line of text, it will move to the end of the line.*

To move the cursor down several lines:

- Hold down  until the cursor moves to the desired position.

To move the cursor to the end of the entire text:

- Hold down  and press .

CODE, ATT & SHIFT KEYS

Most characters can be entered simply by pressing their keys. However, to use special functions or to enter capital letters, accented characters and some symbols, the following special keys are necessary.

CODE KEY

To use a function printed above a key:

- Hold down **Code** and press the key immediately below the desired function.

EXAMPLE

To start the Symbol function:

- Hold down **Code** and press **Alt**.

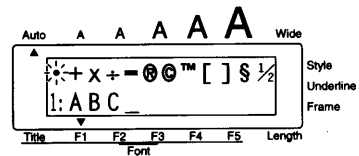
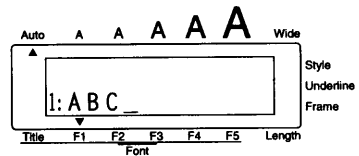

ALT KEY

To type in characters printed in color on the right-hand side of the keys:

- Hold down ^{Symbol} (Alt) and press the key of the desired character written in color. The Alt indicator on the left side of the display lights up while ^{Symbol} (Alt) is held down.

EXAMPLE

To type in “-”:

- Hold down ^{Symbol} (Alt) and press (/) once. The Alt indicator lights up while ^{Symbol} (Alt) is held down.

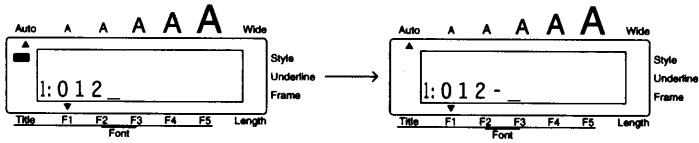

SHIFT KEY



To type in a capital letter or a symbol printed in the top left-hand corner of a key:

- Hold down  and press the key of the desired letter or symbol.

EXAMPLE

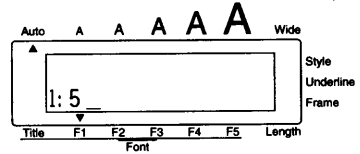
- 1 To type in “%”:



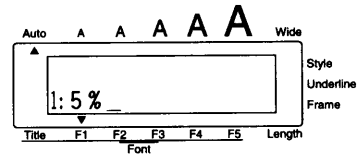

- Hold down  and press .





The Caps mode is similar to holding down the shift key. It allows you to type capital letters continuously.

To type in many capital letters:

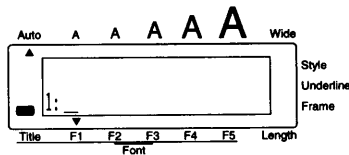
- 1 Hold down  and press . The Caps indicator on the left side of the display lights up.



- 2 Press the keys of the desired letters or symbols.
- 3 To exit Caps mode, hold down  and press . The Caps indicator goes off.

SPACE KEY

The space key lets you add blank spaces between characters in your text. It is different from the right cursor key (), which just moves the cursor without adding blank spaces.

To add a space:

- Press  .

EXAMPLE

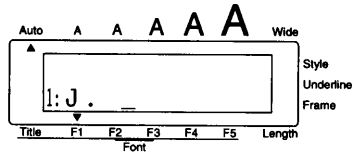
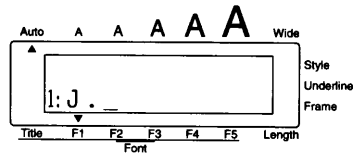

To add a space:

- Press  .



RETURN KEY



Like on a typewriter or word processor, this machine's return key () is used to end a line of text and start another one. When you have finished entering one line, press the return key to make a new line and move the cursor to it.

 A block can only contain one text line when a Title font is used. If you press  when a Title font is selected, the error message "FIXED SIZE!" will appear.

A single block can only contain a maximum of four text lines. If you press  when the cursor is located on the fourth line, the error message "4 LINE LIMIT!" will appear.

Tape Widths	Maximum Number Of Lines That Can Be Printed
1/4" (6 mm)	1
3/8" (9 mm)	2
1/2" (12 mm)	2
3/4" (18 mm)	4
1" (24 mm)	4

The return key can also be used to apply a selected item (e.g., add a symbol or accented character to the text) or to begin printing the set number of labels.

Some questions asking you to confirm a command may appear on the LCD display, especially when the function that you have chosen will delete or affect files. In these cases, pressing  is like answering "yes". To answer "no", press . Refer to *DELETE KEY* on page 39.

To add a new line:

- Press  . The return mark (↵) appears to indicate the end of the line.

EXAMPLE

To add a second line:

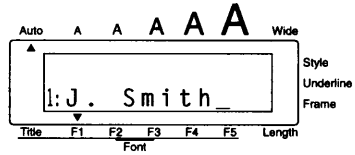

- Press  .

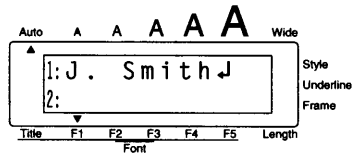



To apply a selected item:

- Press  .

EXAMPLE

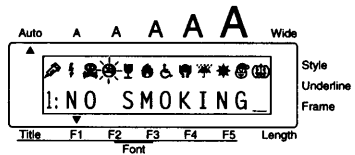
To add "☹" to your text:



- Press  .

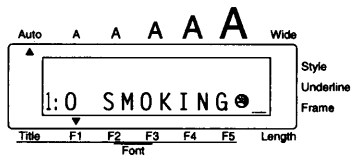

To answer "yes":

- Press  .

EXAMPLE

To clear the display:

- Press  .

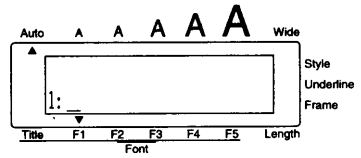
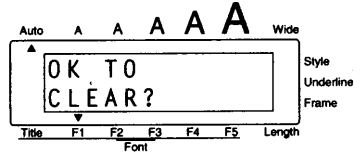

NEW BLOCK FUNCTION

Whenever the number of lines in a section of the label changes, a new block must be created.

☞ A single label can only contain a maximum of five blocks. If the cursor is located in the fifth block when **Code** is held down and **New Block** is pressed, the error message "5 BLOCK LIMIT" will appear.

If the cursor is positioned in the middle of a text block when **Code** is held down and **New Block** is pressed, the block splits into two and the character to the left of the cursor's current position becomes the end of the block.

To add a new block:

- Hold down **Code** and press **New Block** once. The new block mark () appears to indicate the end of the block.

EXAMPLE

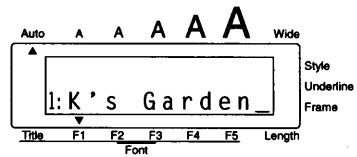

To add a new block:



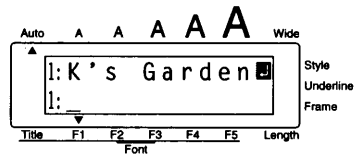

- Hold down **Code** and press **New Block** once.





DELETE KEY





The delete key () allows you to remove characters to the left of the cursor's current position. It differs from the left cursor key (), which only moves the cursor without deleting any characters.

The delete key can also be used to quit most functions and return to the previous display without changing the text.





 *The delete key cannot be used to quit the Bar code function. Hold down  and press  to quit the Bar code function.*

Some questions asking you to confirm a command may appear on the LCD display, especially when the function that you have chosen will delete or affect files. In these cases, pressing  is like answering "no". To answer "yes", press . Refer to *RETURN KEY* on page 35.

To delete one character:

- 1 Press , ,  or  to position the cursor below the character immediately to the right of the character that you wish to delete.
- 2 Press  once.

To delete a sequence of characters:

- 1 Press , ,  or  to position the cursor below the character immediately to the right of the last character that you wish to delete.
- 2 Hold down  until all of the characters that you wish to delete are deleted.

EXAMPLE

To delete "9":

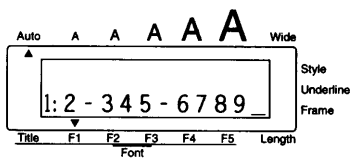

- 1 Press  once.

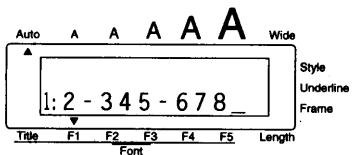

To delete "-678":

- 2 Hold down  until "-678" are deleted.

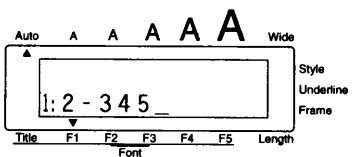

To quit a function without changing your text:

- Press  to return to your text.

EXAMPLE

To quit the Symbol function without adding a symbol to your text:

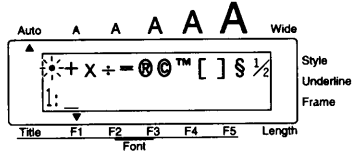

- Press .

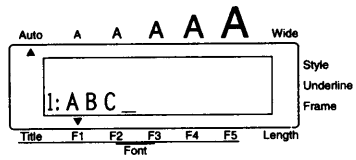

To answer "no":

- Press .

EXAMPLE

To stop the text from being cleared:

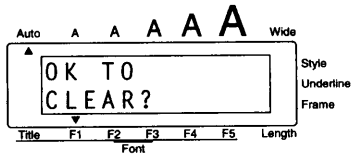

- Press .

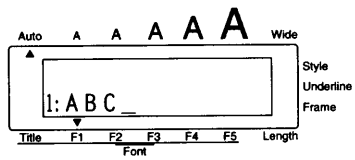

LINE OUT FUNCTION

With the Line Out function, you can easily remove an entire line of text.

To delete a line of text:

1 Press \leftarrow , \rightarrow , Home or End to position the cursor within the line of text that you wish to delete.

2 Hold down Code and press Line out once.

 Each time Line out is pressed while Code is held down, one line of text is deleted.

EXAMPLE

To delete "012-345-6789":

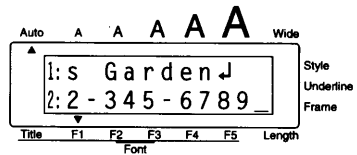

● Hold down Code and press Line out once.

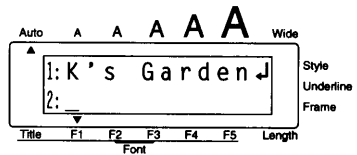

CLEAR FUNCTION

The Clear function is used to remove all characters from the display and return all of the character formats (selected using $\text{\textcircled{1}}$, $\text{\textcircled{2}}$, $\text{\textcircled{3}}$, $\text{\textcircled{4}}$ and $\text{\textcircled{5}}$) and label formats (selected using $\text{\textcircled{T}}$, $\text{\textcircled{E}}$, $\text{\textcircled{U}}$, $\text{\textcircled{I}}$ and $\text{\textcircled{Print}}$) to their default settings. In other words, the display is completely emptied. You can then begin entering new text.

To delete all of the text and return all formats to their default settings:

- 1 Hold down $\text{\textcircled{Code}}$ and press $\text{\textcircled{Clear Del}}$. The message "OK TO CLEAR?" appears on the display.
- 2 Press $\text{\textcircled{New Block}}$.
 To stop the text from being cleared, press $\text{\textcircled{Clear Del}}$. Refer to DELETE KEY on page 39.

EXAMPLE

To clear the display:

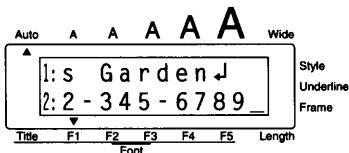

- 1 Hold down $\text{\textcircled{Code}}$ and press $\text{\textcircled{Clear Del}}$.

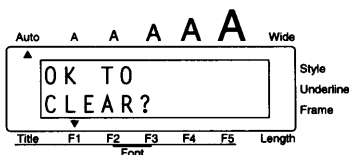

- 2 Press $\text{\textcircled{New Block}}$.

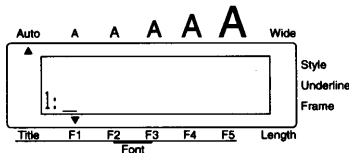

COMPOSITE CHARACTER KEYS







When writing in other languages, composite characters, which consist of a letter and a diacritical mark, are often used. This machine can also display and print these characters. The diacritical marks available are ^, ¨, ´, and `.

Several composite characters can be found on the key tops. Characters such as ü, ç, and ñ can be entered using . Before inputting a composite character as described below, check whether it is already available as a keytop character.

The following diacritical mark and letter combinations are available:

Diacritical Marks	Letters Which Can Be Combined
^	A E I O U a e i o u
¨	A E I O U a e i o u
´	A E I O U a e i o u
`	A E I O U a e i o u

To type in a composite character:

- 1 Hold down  and press the key (, ,  or ) of the desired diacritical mark. The diacritical mark is added to the text. The Alt indicator on the left side of the display lights up while  is held down.
- 2 Press the key of the letter that you wish to combine with the diacritical mark. The letter and the diacritical mark flash alternately within the text.
 *If the letter of the key that you pressed cannot be combined with the diacritical mark (see the above table), the letter is added to the text instead of the diacritical mark.*

EXAMPLE

To add the composite character "ö":

- 1 Hold down Alt and press W .

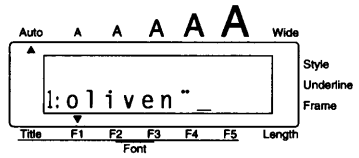
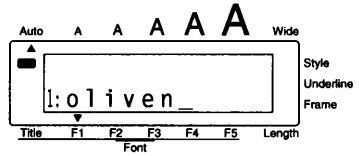

- 2 Press O .

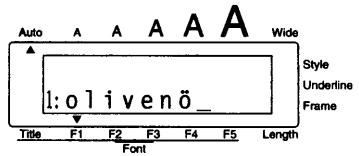

ACCENT FUNCTION

The Accent function can also be used to add accented characters to your text. Many of these characters either can be entered using the composite character keys or can be found on the keys and typed in using ^{Symbol} (Alt). Refer to *COMPOSITE CHARACTER KEYS* on pages 44 and 45.

The accented characters are grouped according to the capital or small letter that they are combined with. The following accented characters are available:

Letters	Accented Characters	Letters	Accented Characters
a	ä á à â ã æ	l	ĺ ł ľ
A	Ä Á Â Ã Ä Æ	n	ñ
c	ç	N	Ñ
C	Ç	o	ö ó ò ô õ
e	ë é è ê ë	O	Ö Ó Ô Õ
E	Ë É Ê Ë	u	ü ú û
i	ï í î	U	Ü Ú Û

To type in an accented character:

- 1 Hold down ^{Code} (Alt) and press ^{Accent} (A). The message "a – u / A – U?" appears on the display.
- 2 Press the key of the letter in the desired accented character.
 - ☞ If you wish to type in a capital letter, hold down ^{Caps} (Shift) while pressing the letter key.
- 3 Press ^{Left} (←) or ^{Right} (→) until the desired accented character flashes.
- 4 Press ^{New Block} (↵). The letter and the accent flash alternately with the text.
 - ☞ If you wish to type in a sequence of accented characters, hold down ^{Code} (Alt) while pressing ^{New Block} (↵). Continue adding accented characters to your text by selecting them, then holding down ^{Code} (Alt) while pressing ^{New Block} (↵). Press just ^{New Block} (↵) after the last character in the sequence is chosen.

EXAMPLE

To add the accented character "É":

- 1 Hold down **Code** and press **Accent** (A).

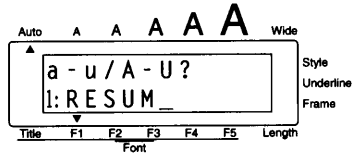

- 2 Hold down **Caps** (SHIF) and press **Frame** (E).

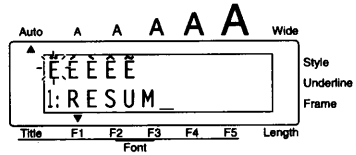

- 3 Press **▶▶** until "É" flashes.

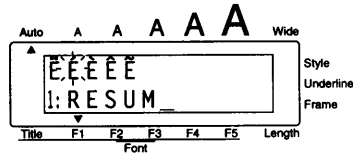

- 4 Press **New Block** (←).

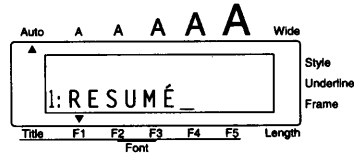

SYMBOL FUNCTION

In addition to the letters, symbols and numerals on the key tops, there are 126 additional marks available with the Symbol function.

The following symbols are available:

•	+	×	÷	=	®	©	™	[]	\$	½
☎	♥	★	²	³	Æ	∞	↑	↓	→	←	°
①	②	③	④	⑤	⑥	⑦	⑧	⑨	⑩	±	∅
1	2	3	4	5	6	7	8	9	-	+	±
0	1	2	3	4	5	6	7	8	9	-	+
✂	✂	✂	✂	✂	✂	✂	✂	✂	✂	✂	✂
✂	✂	✂	✂	✂	✂	✂	✂	✂	✂	✂	✂
✂	✂	✂	✂	✂	✂	✂	✂	✂	✂	✂	✂
✂	✂	✂	✂	✂	✂	✂	✂	✂	✂	✂	✂
✂	✂	✂	✂	✂	✂	✂	✂	✂	✂	✂	✂
✂	✂	✂	✂	✂	✂	✂	✂	✂	✂	✂	✂
✂	✂	✂	✂	✂	✂	✂	✂	✂	✂	✂	✂

To type in a symbol:

- 1 Hold down **Code** and press **Alt**. A row of symbols appear in the display.
- 2 Press **Home** or **End** to display different rows of symbols and press **Left** or **Right** until the desired symbol flashes.
- 3 Press **New Block**. The symbol appears in the text.

 If you wish to type in a sequence of symbols, hold down **Code** while pressing **New Block**. Continue adding symbols to your text by selecting them, then holding down **Code** while pressing **New Block**. Press just **New Block** after the last symbol in the sequence is chosen.

EXAMPLE

To add the symbol "☹":

- ① Hold down **Code** and press **Symbol**.

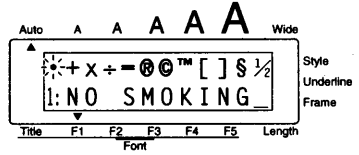

- ② Press **End** or **Home** until the row containing "☹" appears, then press **Left Arrow** or **Right Arrow** until "☹" flashes.

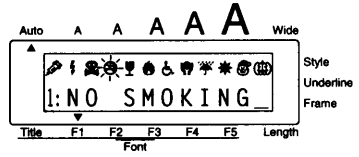

- ③ Press **New Block**.

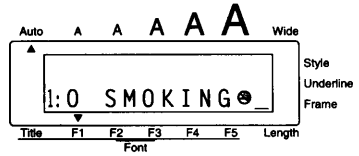

LENGTH FUNCTION

When the Length function is first selected, the length of the text and both margins is briefly displayed. With this function, you can set the label length between 1.5" (3.8 cm) and 10.0" (25.4 cm), choose from seven different preset lengths, or select AUTO, which automatically adjusts the label length to fit your text.

The default Length setting is AUTO. If any setting other than AUTO is selected, the Length indicator below the display lights up.

The following preset lengths are also available:

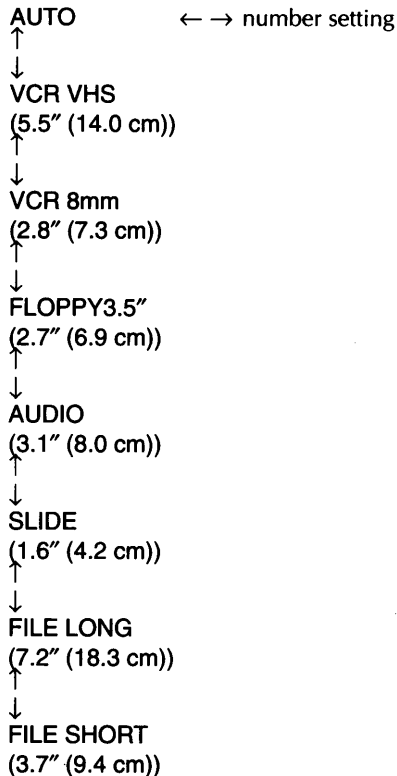

To set the length of the label:

- 1 Hold down **Code** and press **Length** once. The length of the current label briefly appears in the display.
- 2 Press **←** or **→** to select either AUTO, which allows you to choose from preset lengths, or the number setting, which allows you enter a specific length.

 To change the setting from a preset length to a number setting, select AUTO first.

3 Press or to select the desired setting.

To change the units (inches or centimeters) that the lengths are displayed in, select the number setting, then press until the desired units are displayed.

To change the number values in 1" (1.0 cm) steps, hold down either or , then release the key when the desired setting is displayed.

The default setting (AUTO with a default length of 4.0" (10.2 cm)) can be selected by pressing .

4 Press to apply the selected Length setting to the text.

The Length indicator lights up if any setting other than AUTO is selected.

EXAMPLE

To select the FLOPPY3.5" setting:

1 Hold down and press .

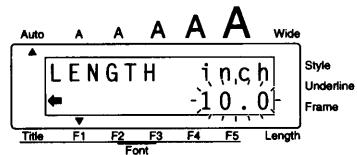
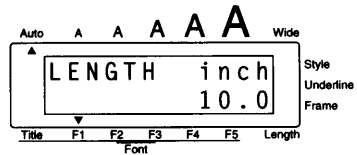

2 Press to select the AUTO setting.

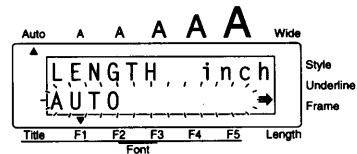

3 Press or until the FLOPPY3.5" setting is displayed.

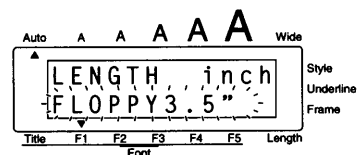

4 Press .

To set the length back to 10.0":

5 Hold down **Code** and press **Length**.

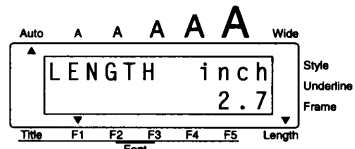

6 Press **Home** or **End** until the AUTO setting is selected.

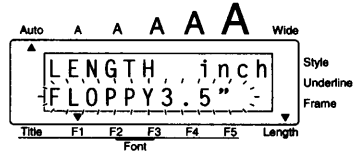

7 Press **Right Arrow** to select the number setting.

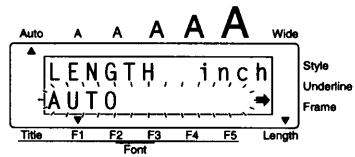

8 Press **Home** or **End** until setting 10.0 is displayed.

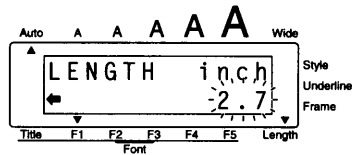



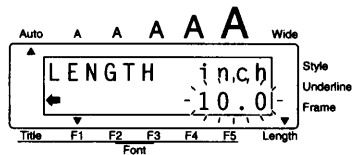

9 Press **New Block**.



STAMP FUNCTION

The Stamp function allows you to quickly and easily create your own stamp stencil films for customized stamps. Select this function to automatically center the text and adjust the tape length and margins to a perfect format for the pre-inked stamp film holders. Since the stamp holder is reusable, just make a new stamp stencil film and replace the one in the holder.

To make a stamp:

- 1 Type in your text, then insert a stamp film cassette in the tape compartment.
 *Be sure to install a 3/4" (18-mm)- or 1" (24-mm)-wide stamp film cassette.*
When making a large stamp, use an AC Adapter (model AD-60). Creating a large stamp while using batteries may cause poor stamp quality.
- 2 Hold down  and press  once. The message "STAMP FORMAT" appears in the display.
- 3 Press . The text is formatted for a stamp: centered within the preset message area with the tape length and margins automatically adjusted.
- 4 Press  to carve the text out of the stamp stencil film.
- 5 Push down on the tape cutter lever, remove the backing paper from the stamp stencil film and affix it to the ink pad of a stamp film holder.

EXAMPLE

To cut a stamp:

- 1 Enter the text and insert a stamp film cassette in the tape compartment.

- 2 Hold down  and press .

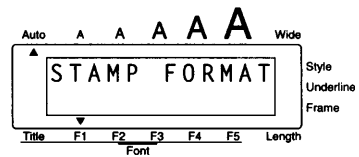

- 3 Press .

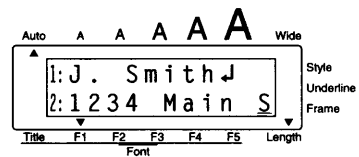

- 4 Press  .

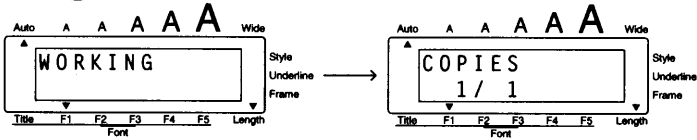

- 5 Push down on the tape cutter lever to cut the stamp stencil film.

To affix a stamp:

- 6 Remove the stamp frame from around the stamp film holder ink pad one side at a time, then remove the protective seal covering the ink pad and the backing paper from the stamp stencil film.
- 7 With the glossy side of the stamp stencil film upward, align one of its ends with the slit on the side of the stamp film holder.

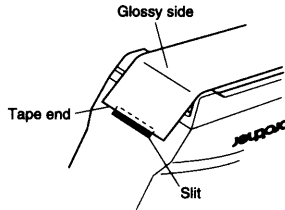

- 8 Hold the end of the stamp stencil film in place with your thumb, then pass the tape through the guides while pulling it tight.

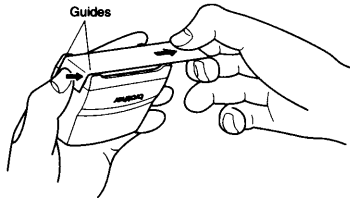

- 9 Fold the other end of the stamp stencil film over the other side of the stamp film holder and hold it in place with your finger.

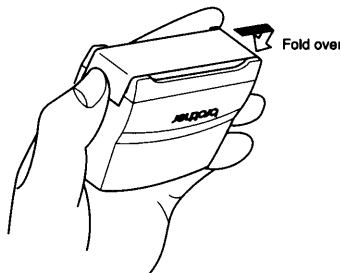

- 10 Fit the stamp frame over the stamp stencil film and push it into place.

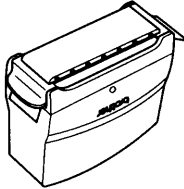
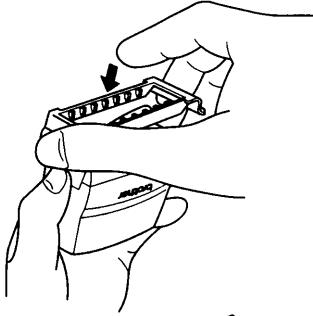

- 11 Insert the stamp film holder straight into its cap.

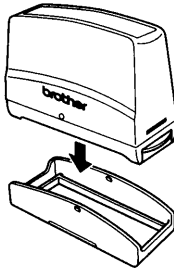

⚠ Be sure that the stamp is correctly covered in order to prevent ink spills.

SIZE & WIDE FUNCTIONS

The character size can be adjusted using both the Size and Wide functions. Since the character size that can be used depends on the width of the tape, the following table shows the character sizes that can be used with each tape width.

Tape Widths	Sizes (in points)
1/4" (6 mm)	10, 13
3/8" (9 mm)	10, 13, 19
1/2" (12 mm)	10, 13, 19
3/4" (18 mm)	10, 13, 19, 26, 38
1" (24 mm)	10, 13, 19, 26, 38

The default Size setting is AUTO and the default Wide setting is OFF. The currently selected Size and Wide settings are always shown by the indicators above the display.

With the AUTO Size setting, the machine compares your text with the width of the installed tape and automatically adjusts the characters to the largest possible size. However, five other point sizes are also available and each can be printed in wide characters.

Size Settings (in points)	Wide function OFF	Wide function ON
10	ABC	ABC
13	ABC	ABC
19	ABC	ABC

Size Settings (in points)	Wide function OFF	Wide function ON
26	ABC	ABC
38	ABC	ABC

To change the Size setting:

- Hold down **Code** and press **Size** once. The currently selected Size setting appears in the display.

 The indicators above the display also show the current Size setting.
- Keep **Code** held down and continue pressing **Size** until the desired setting appears in the display and is shown by the indicators above the display.
- Release **Code** to apply the selected Size setting to all of the characters in the text.

EXAMPLE

To select the 26 point Size setting:

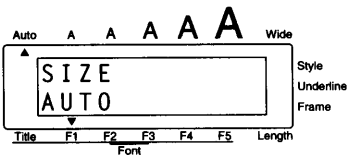
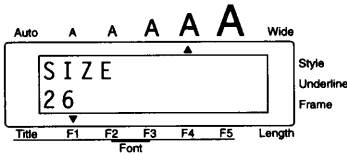
- Hold down **Code** and press **Size** once.
 
- Keep **Code** held down and continue pressing **Size** until the 26 Size setting is displayed.
 
- Release **Code**.

To change the Wide setting:

- 1 Hold down **Code** and press **Wide** once. The currently selected Wide setting appears in the display.
- 2 Keep **Code** held down and continue pressing **Wide** until the desired setting appears in the display.
- 3 Release **Code** to apply the selected Wide setting to all of the characters in the text.
 *The Wide indicator lights up if the ON setting is selected.*

EXAMPLE

To turn on the Wide function:

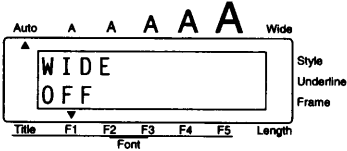
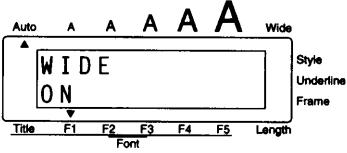
- 1 Hold down **Code** and press **Wide** once.

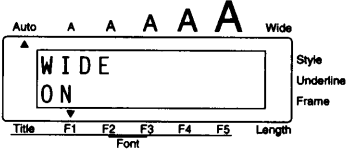
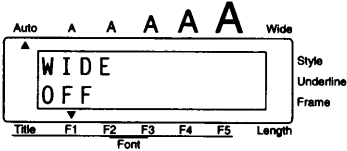
- 2 Keep **Code** held down and press **Wide** until the ON setting is displayed.

- 3 Release **Code**.



STYLE FUNCTION

You can choose from twelve different character styles to apply to your text.

 Characters printed using the smaller sizes may be difficult to read if certain Style settings (e.g., I+SHADOW) are selected.





The following Style settings are available:

NORMAL	ITALIC
BOLD	I+BOLD (italic & bold)
OUTLINE	I+OUTLINE (italic & outline)
SOLID	I+SOLID (italic & shadow)
SHADOW	I+SHADOW (italic & shadow)
O+SHADOW (outline & shadow)	I+O+SHADOW (italic & outline & shadow)

The default Style setting is NORMAL. If any setting other than NORMAL is selected, the Style indicator on the right side of the display lights up.

Refer to *Reference* at the end of this section for samples of the available settings.

To change the Style setting:

- 1 Hold down  and press  once. The currently selected Style setting appears in the display.
- 2 Keep  held down and continue pressing  until the desired setting appears in the display.
- 3 Release  to apply the selected Style setting to all of the characters in the text.

 The Style indicator lights up if any setting other than NORMAL is selected.

EXAMPLE

To select the I+SHADOW Style setting:

- 1 Hold down  and press  once.

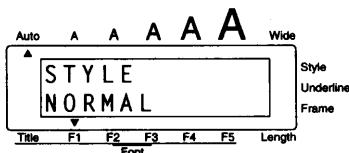

- Keep **Code** held down and continue pressing **Style** until the I+SHADOW Style setting is displayed.

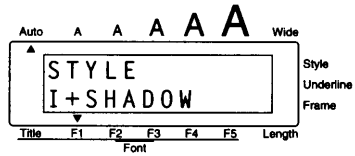

- Release **Code**.

REFERENCE

Font Settings	Style Settings			
	NORMAL	BOLD	OUTLINE	SOLID
HELSINKI	abc	abc	abc	abc
BRUSSELS	abc	abc	abc	abc
BERMUDA*	<i>abc</i>	<i>abc</i>	<i>abc</i>	<i>abc</i>
TITLE SAN DIEGO	ABC	ABC	ABC	ABC
TITLE CALGARY	<i>ABC</i>	<i>ABC</i>	<i>ABC</i>	<i>ABC</i>
TITLE FLORIDA	ABC	ABC	ABC	ABC
TITLE ISTANBUL*	ABC	ABC	ABC	ABC
TITLE U.S.*	ABC	ABC	ABC	ABC

*: These fonts are only available on the P-Touch 350.

Font Settings	Style Settings			
	SHADOW	O+SHADOW	ITALIC	I+BOLD
HELSINKI	abc	abc	<i>abc</i>	<i>abc</i>
BRUSSELS	abc	abc	<i>abc</i>	<i>abc</i>
BERMUDA*	<i>abc</i>	<i>abc</i>	<i>abc</i>	<i>abc</i>
TITLE SAN DIEGO	ABC	ABC	<i>ABC</i>	<i>ABC</i>
TITLE CALGARY	<i>ABC</i>	<i>ABC</i>	<i>ABC</i>	<i>ABC</i>
TITLE FLORIDA	ABC	ABC	<i>ABC</i>	<i>ABC</i>
TITLE ISTANBUL*	ABC	ABC	<i>ABC</i>	<i>ABC</i>
TITLE U.S.*	ABC	ABC	<i>ABC</i>	<i>ABC</i>

*: These fonts are only available on the P-Touch 350.

Font Settings	Style Settings			
	I+OUTLINE	I+SOLID	I+SHADOW	I+O+SHADOW
HELSINKI	<i>abc</i>	abc	<i>abc</i>	<i>abc</i>
BRUSSELS	<i>abc</i>	abc	<i>abc</i>	<i>abc</i>
BERMUDA*	<i>abc</i>	abc	<i>abc</i>	<i>abc</i>
TITLE SAN DIEGO	<i>ABC</i>	ABC	<i>ABC</i>	<i>ABC</i>
TITLE CALGARY	<i>ABC</i>	ABC	<i>ABC</i>	<i>ABC</i>
TITLE FLORIDA	<i>ABC</i>	ABC	<i>ABC</i>	<i>ABC</i>
TITLE ISTANBUL*	<i>ABC</i>	ABC	<i>ABC</i>	<i>ABC</i>
TITLE U.S.*	<i>ABC</i>	ABC	<i>ABC</i>	<i>ABC</i>

*: These fonts are only available on the P-Touch 350.

UNDERLINE FUNCTION

You can emphasize your text by crossing it out or underlining it.

The default Underline setting is OFF; however, two other settings are also available. If any setting other than OFF is selected, the Underline indicator on the right side of the display lights up.

ON ABC

STRIKEOUT

~~ABC~~

To change the Underline setting:

- 1 Hold down **Code** and press **Underline** once. The currently selected Underline setting appears in the display.
- 2 Keep **Code** held down and continue pressing **Underline** until the desired setting appears in the display.
- 3 Release **Code** to apply the selected Underline setting to all of the characters in the text.
 *The Underline indicator lights up if any setting other than OFF is selected.*

EXAMPLE

To select the ON Underline setting:

- 1 Hold down **Code** and press **Underline** once.
- 2 Keep **Code** held down and continue pressing **Underline** until the ON setting is displayed.
- 3 Release **Code**.

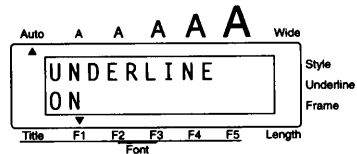
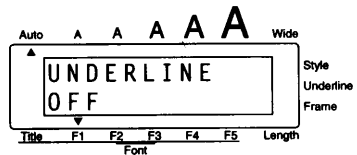

FONT FUNCTION

With the Font function, you can choose from a variety of fonts for your text.

The following Font settings are available on the PT-330:

HELSINKI, BRUSSELS, TITLE SAN DIEGO, TITLE CALGARY and TITLE FLORIDA

The following Font settings are available on the PT-350:



HELSINKI, BRUSSELS, BERMUDA, TITLE SAN DIEGO, TITLE CALGARY, TITLE FLORIDA, TITLE ISTANBUL and TITLE U.S.

The default Font setting is HELSINKI. The currently selected Font setting is always shown by the Font indicators below the display.



 The *TITLE* fonts are only available if the text consists of only one line and if 1/2" (12-mm)-, 3/4" (18-mm)- or 1" (24-mm)-wide tape is installed. In addition, the text will only be printed in capital letters and cannot be printed vertically or with other character sizes.

Refer to *Reference* at the end of this section for samples of the available settings.

To change the Font setting:

1 Hold down  and press  once. The currently selected Font setting appears in the display.

 The Font indicators below the display also show the current Font setting.

2 Keep  held down and continue pressing  until the desired setting appears in the display and is shown by the Font indicators.

3 Release  to apply the selected Font setting to all of the characters in the text.

EXAMPLE

To select the TITLE FLORIDA Font setting:

● Hold down  and press  once.

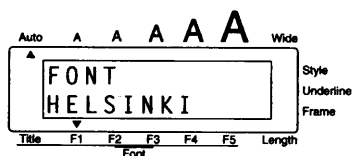

- ② Keep **Code** held down and continue pressing **Font** until the TITLE FLORIDA Font setting is displayed.

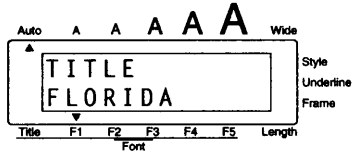

- ③ Release **Code**.

REFERENCE

Font Settings	Font Samples	Display Indicators	
		PT-330	PT-350
HELSINKI	<i>abc</i>	F1	F1
BRUSSELS	<i>abc</i>	F2	F2
BERMUDA	<i>abc</i>	Not available on the PT-330	F3
TITLE SAN DIEGO	ABC	Title F3	Title F1

Font Settings	Font Samples	Display Indicators	
		PT-330	PT-350
TITLE CALGARY	<i>ABC</i>	Title F4	Title F2
TITLE FLORIDA	ABC	Title F5	Title F3
TITLE ISTANBUL	ABC	Not available on the PT-330	Title F4
TITLE U.S.	ABC	Not available on the PT-330	Title F5

FRAME FUNCTION

With the Frame function, you can choose from various frames and highlights to design a more decorative or emphasized label.

The following Frame settings are available on the PT-330:

OFF, SQUARE, ROUND, DOT, CANDY, POINTING, NAME PLATE

The following Frame settings are available on the PT-350:

OFF, SQUARE, ROUND, DOT, DIAMOND, SLANT, CANDY, POINTING, NAME PLATE, DOG, MOVIE FILM, DINOSAUR, TELEPHONE, HANDS, WINDOW, BANNER

The default Frame setting is OFF; however, other settings are also available. If any setting other than OFF is selected, the Frame indicator on the right side of the display lights up.

Refer to *Reference* at the end of this section for samples of the available settings.

To change the Frame setting:

- 1 Hold down **Code** and press **Frame E** once. The currently selected Frame setting appears in the display.
- 2 Keep **Code** held down and continue pressing **Frame E** until the desired setting appears in the display.
- 3 Release **Code** to apply the selected Frame setting to the entire text.
 *The Frame indicator lights up if any setting other than OFF is selected.*







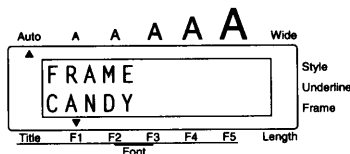
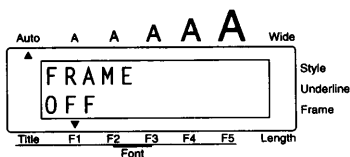







EXAMPLE

To select the CANDY Frame setting:

- 1 Hold down **Code** and press **Frame E** once.
- 2 Keep **Code** held down and continue pressing **Frame E** until the CANDY Frame setting is displayed.
- 3 Release **Code**.



REFERENCE

Frame Settings	Frame Samples	Frame Settings	Frame Samples
OFF	ABC	CANDY	
SQUARE		POINTING	
ROUND		NAME PLATE	
DOT		DOG (Not available on the PT-330)	
DIAMOND (Not available on the PT-330)		MOVIE FILM (Not available on the PT-330)	
SLANT (Not available on the PT-330)		DINOSAUR (Not available on the PT-330)	
TELEPHONE (Not available on the PT-330)		WINDOW (Not available on the PT-330)	
HANDS (Not available on the PT-330)		BANNER (Not available on the PT-330)	

TAPE FUNCTION

The Tape function allows you to adjust the size of the margins on the left and right sides of your text.

The default Tape setting is #####; however, four other settings are also available.

####

(25 mm
margins)



-

(no margins)

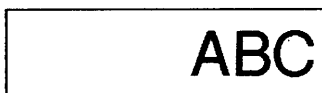

#

(4 mm
margins)



##

(8 mm
margins)

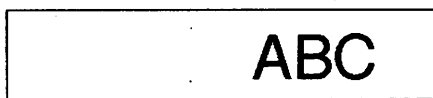



###

(12 mm
margins)







 If an instant-lettering (rub-on) or iron-on tape cassette is installed, the text will be printed with 1" (25 mm) margins, even if a different Tape setting is selected.

After printing a label using the - Tape setting, hold down  and press  once to feed the tape before pushing down on the tape cutter lever to cut it. Otherwise some of the printed characters may be cut off.

After printing using the #, ## or ### Tape settings, push down on the tape cutter lever to cut off the label, then use scissors to cut along the printed dots (:) to center the text within the label.

To change the Tape setting:

- 1 Hold down  and press  once. The currently selected Tape setting appears in the display.
- 2 Keep  held down and continue pressing  until the desired setting appears in the display.
- 3 Release  to apply the selected Tape setting to the entire text.

EXAMPLE

To select the ## Tape setting:

- Hold down **Code** and press **Tape** once.

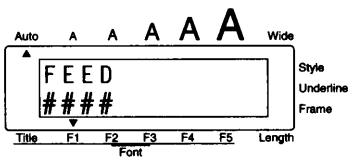

- Keep **Code** held down and continue pressing **Tape** until the ## Tape setting is displayed.

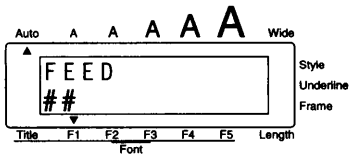

- Release **Code**.

HORIZONTAL ALIGNMENT FUNCTION

You can choose to align the characters in each text block in one of four ways. In addition, if the Length function was used to set the length of the label, the blocks will align within the label according to the selected Horizontal Alignment setting.

The default Horizontal Alignment setting is LEFT; however, three other settings are also available.

LEFT	AB CDE FG	RIGHT	AB CDE FG
CENTER	AB CDE FG	JUSTIFY	A B CDE F G

To change the Horizontal Alignment setting:

- 1 Hold down **Code** and press **H.All** once. The currently selected Horizontal Alignment setting appears in the display.
- 2 Keep **Code** held down and continue pressing **H.All** until the desired setting appears in the display.
- 3 Release **Code** to apply the selected Horizontal Alignment setting to the entire text.

EXAMPLE

To select the RIGHT Horizontal Alignment setting:

- 1 Hold down **Code** and press **H.All** once.
- 2 Keep **Code** held down and continue pressing **H.All** until the RIGHT Horizontal Alignment setting is displayed.
- 3 Release **Code**.

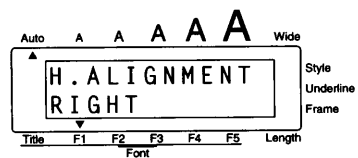
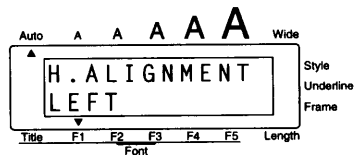



VERTICAL PRINTING FUNCTION

This function allows you to print the characters in your text vertically along the length of your label.





The default Vertical Printing setting is OFF.

ON







 If  is pressed while the Vertical Printing function is set to ON and a TITLE font is selected, the text is printed horizontally.

To change the Vertical Printing setting:

- 1 Hold down  and press  once. The currently selected Vertical Printing setting appears in the display.
- 2 Keep  held down and continue pressing  until the desired setting appears in the display.
- 3 Release  to apply the selected Vertical Printing setting to the entire text.

EXAMPLE

To select the ON Vertical Printing setting:

- 1 Hold down  and press  once.
- 2 Keep  held down and continue pressing  until the ON setting is displayed.
- 3 Release .

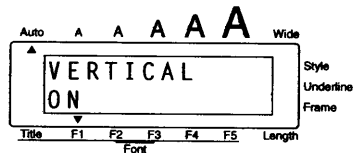
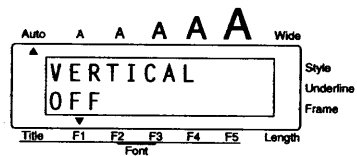

MIRROR PRINTING FUNCTION

With this function, you can print your text so that the characters can be read from the adhesive side of the tape. If mirror-printed labels are attached to glass, such as in a showroom or some other clear material, they can be read correctly from the opposite side.





 When using the Mirror Printing function, the text should be printed on clear tape.

The default Mirror Printing setting is OFF.

ON





ABC

To change the Mirror Printing setting:

- 1 Hold down  and press  once. The currently selected Mirror Printing setting appears in the display.
- 2 Keep  held down and continue pressing  until the desired setting appears in the display.
- 3 Release  to apply the selected Mirror Printing setting to the entire text.

EXAMPLE

To select the ON Mirror Printing setting:

- 1 Hold down  and press  once.
- 2 Keep  held down and continue pressing  until the ON setting is displayed.
- 3 Release .

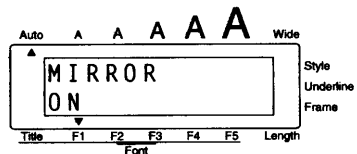
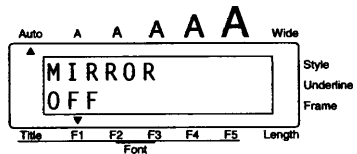

BAR CODE FUNCTION

The Bar Code function, which enables bar codes to be printed as part of labels, is one of this machine's most advanced features.

 This section will explain how to enter a bar code into your text. It is not intended as a comprehensive introduction to the concept of bar coding. For more detailed information, please consult one of the many reference books available.

Since this machine is not specifically designed for special bar code label making, some bar code readers may not be able to read the labels.

Print bar codes with black ink on a white background.

Four different parameters enable you to create custom bar codes.

PARAMETER
PROTOCOL

SETTINGS
CODE 39, I-2/5, EAN13, EAN8,
UPC-A, UPC-E*, CODABAR*

*: Only available on the P-Touch 350.

WIDTH (bar code width)

LARGE, SMALL

UNDER#S (numbers printed below bar code)

ON, OFF



CHECK DIG. (check digit)

OFF, ON



The default settings are CODE 39 PROTOCOL, LARGE WIDTH, ON UNDER#S and OFF CHECK DIG.



 We recommend printing bar codes using the ##### Tape setting and the LARGE bar code width. Bar codes printed using a smaller Tape setting or a SMALL bar code width may be difficult to read.

To use the Bar Code function:

1 Hold down  and press  once.

 If the cursor was located below the right bar code mark, the current bar code data will be displayed.



A label can only contain a maximum of five bar codes. If five bar codes have already been entered when  is held down and  is pressed, the error message "5 BARS LIMIT" will appear.

To quit the Bar Code function without making any changes, hold down  and press .



2 Enter or edit the bar code data.

To change the bar code parameter settings:

3 Press .

 To display the bar code data without changing the parameter settings, press .



4 Press  or  until the parameter that you wish to change appears.

5 Press  or  until the desired setting is displayed.



6 Repeat steps 4 and 5 until all parameters are set as you wish.

7 Press  .

To add a special character to the bar code data:

8 Press  or  until the cursor is below the character immediately to the right of the position where you want to add the special character.

9 Hold down  and press  .

10 Press  or  until the desired special character is displayed.

 The following special characters can only be entered when using protocols CODE 39 or CODABAR.

Symbol	Character
1	+
2	\$

11 Press  to add the selected special character to the bar code data.

To add the bar code to your text:

12 Press  .

EXAMPLE

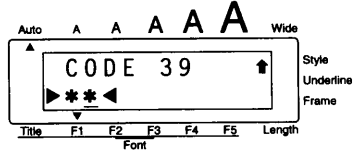

To add a bar code to the label:

1 Hold down  and press  once.



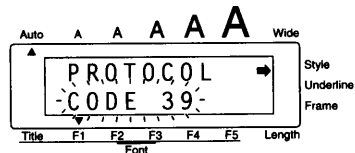

2 Press  .

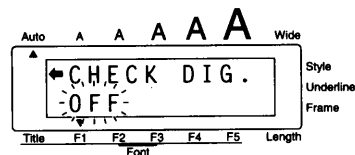

3 Press  or  until the CHECK DIG. parameter is displayed.





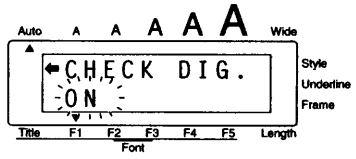

4 Press  or  until the ON setting is displayed.

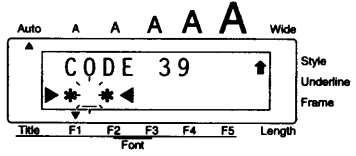

5 Press .



6 Press , , , then .

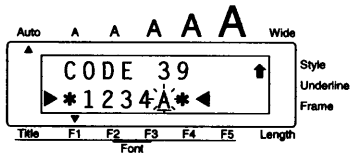





7 Press .

PRINT KEY & FEED FUNCTION



After you have entered your text and chosen the desired format settings, you are ready to print.

To print a label:

- Press  once. The message “WORKING” appears in the display just before printing begins, then “COPIES 1/1” is displayed.

 After printing using the – Tape setting, hold down  and press  once to feed the tape before cutting it, otherwise some of the printed characters may be cut off.

To feed the tape:

- Hold down  and press  once. 1-1/6” (28 mm) of tape is fed out.

To cut the tape:

- Push down on the tape cutter lever.



 In order to prevent damaging the tape, do not try to cut it while printing or feeding. Pushing down on the tape cutter lever too far may break it.

EXAMPLE

To make a label using the - Tape setting:

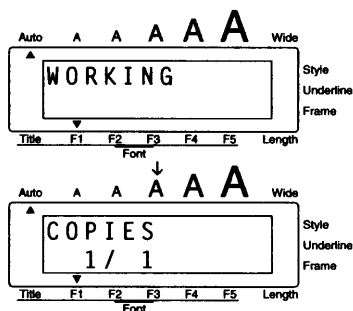
- 1 Press  once.



- 2 Hold down  and press  once.
- 3 Push down on the tape cutter lever.

NUMBERING FUNCTION

This function can be used to print a number of copies of the same text while increasing certain characters (letters or numbers) with each printed label.

To use the Numbering function:

1 Press , , or to position the cursor below the first character (letter or number) that you wish to include in the numbering field.

2 Hold down and press once. The message "SELECT FIELD" appears in the display and the first character of the numbering field flashes.

3 Press or until all characters that you wish to include in the field flash.

Up to five characters can be selected for the numbering field. If more than five are selected, the error message "WRONG SELECT!" appears in the display.

A numbering field must be located entirely within one line of text of a single block.

4 Press . The message "NUMBER" appears in the display.

5 Press or to select the number of labels that you wish to print.

6 Press to begin printing the labels. The message "WORKING" appears in the display just before printing begins, then the number of each copy is displayed while it is being printed.

Letters and numbers simply increase as shown below:

0 → 1 → ... → 9 → 0 → ...

A → B → ... → Z → A → ...

a → b → ... → z → a → ...

A0 → A1 → ... → A9 → B0 → ...

Spaces (shown as underlines) in the example below) can be used to adjust the space between characters or to control the number of digits printed:

 A → B → ... → Z → AA → ...

 0 → 1 → ... → 99 → 0 → ...

7 Push down on the tape cutter lever to cut the tape, then use scissors to cut along the printed dots to separate the labels.

After printing using the – Tape setting, hold down and press once to feed the tape before cutting it, otherwise some of the printed characters may be cut off.

EXAMPLE

To print three labels with numbers 1A, 1B and 1C:

① Position the cursor below "A".

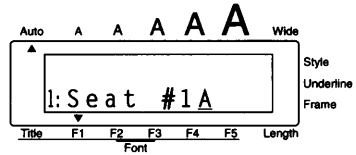

② Hold down **Code** and press **Q** once.

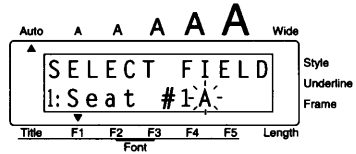

③ Press **New Block**.

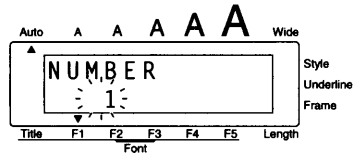

④ Press **Home** or **End** until setting 3 is displayed.

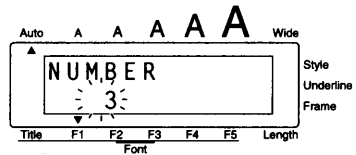

⑤ Press **New Block**.

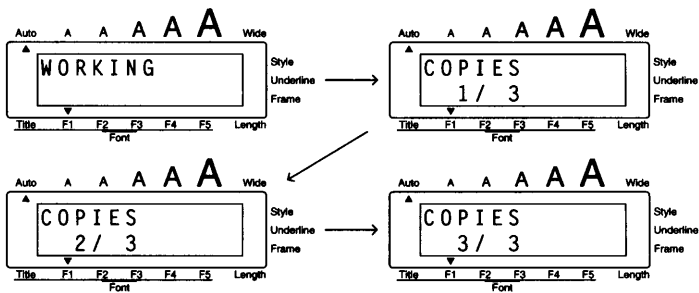

- ⑥ Push down on the tape cutter lever to cut the tape, then use scissors to cut along the printed dots to separate the labels.

Seat #1A Seat #1B Seat #1C

REPEAT PRINTING FUNCTION

This function allows you to print up to 99 copies of the same text.

To use the Repeat Printing function:

- 1 Hold down **Code** and press **Repeat (W.)** once. The message "COPIES" appears in the display.
- 2 Press **Home** or **End** to select the number of labels that you wish to print.
- 3 Press **New Block** to begin printing the labels. The message "WORKING" appears in the display just before printing begins, then the number of each copy is displayed while it is being printed.
- 4 Push down on the tape cutter lever to cut the tape, then use scissors to cut along the printed dots to separate the labels.

 After printing using the – Tape setting, hold down **Code** and press **Feed Space** once to feed the tape before cutting it, otherwise some of the printed characters may be cut off.

EXAMPLE

To print three copies of a label:

- 1 Hold down **Code** and press **Repeat (W.)** once.
- 2 Press **Home** or **End** until setting 3 is displayed.

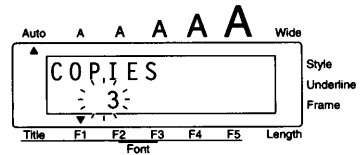
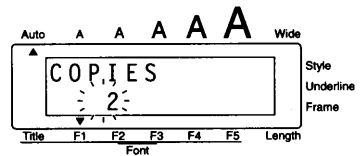

3 Press  .

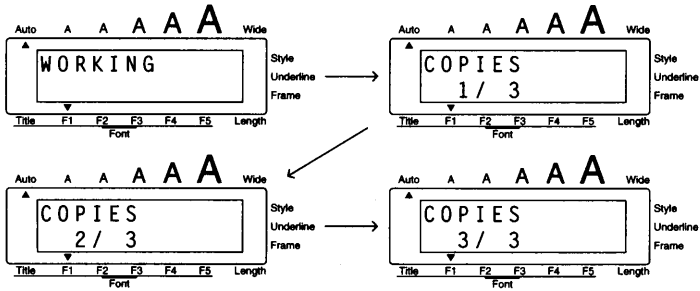

4 Push down on the tape cutter lever to cut the tape, then use scissors to cut along the printed dots to separate the labels.

Bill Reynolds
29 South Main St.
Los Angeles, CA 88888
012-345-6789

Bill Reynolds
29 South Main St.
Los Angeles, CA 88888
012-345-6789

Bill Reynolds
29 South Main St.
Los Angeles, CA 88888
012-345-6789



CALENDAR FUNCTION



(This function is only available on the PT-350.)

The Calendar function allows you to print out a calendar of any month or year from 1901 to 2099.

 Calendars should be printed on 3/4" (18-mm)- or 1" (24-mm)-wide tape.

To use the Calendar function:

① Hold down  and press  once.

 If text has already been entered, the message "OK TO CLEAR TEXT BUFFER?" appears in the display. To continue using the Calendar function, press . All character and label formats except the Tape, Frame and Mirror Printing settings return to their default settings.



② Press  or  to select either YEAR or MONTH.

③ Use the number keys to enter the desired year or month. To print the calendar of an entire year, only enter the year. To print the calendar of only one month, enter both the year and the month.

 If a year is entered, but "0" is entered for the MONTH setting, the calendar for the entire year is printed.

④ Press  to print the label. The message "WORKING" appears in the display just before printing begins, then "COPIES 1/1" is displayed.

 The calendars are printed using the selected Tape, Frame and Mirror Printing settings.

After printing using the – Tape setting, hold down  and press  once to feed the tape before cutting it, otherwise some of the printed characters may be cut off.

EXAMPLE

To print a calendar of August 1997:

① Hold down  and press  once.

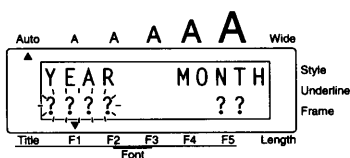

2 Press $\text{Size } \left(\begin{smallmatrix} 1 \\ 1 \end{smallmatrix} \right)$, $\text{M.Del } \left(\begin{smallmatrix} 6 \\ 6 \end{smallmatrix} \right)$, $\text{M.Del } \left(\begin{smallmatrix} 6 \\ 6 \end{smallmatrix} \right)$, then $\text{Store } \left(\begin{smallmatrix} 4 \\ 7 \end{smallmatrix} \right)$.

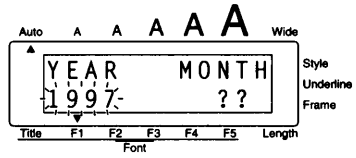

3 Press $\text{DP} \left(\begin{smallmatrix} \triangleright \\ \triangleright \end{smallmatrix} \right)$ until "MONTH" is selected.

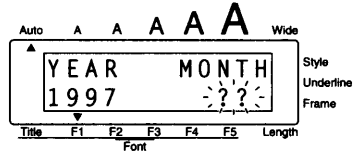

4 Press $\text{Recall } \left(\begin{smallmatrix} 8 \\ 8 \end{smallmatrix} \right)$.

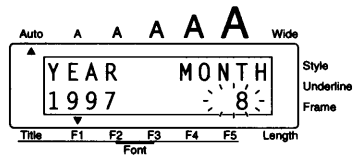

5 Press $\text{New Block } \left(\begin{smallmatrix} \leftarrow \\ \leftarrow \end{smallmatrix} \right)$.

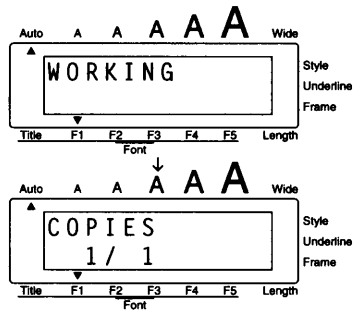

MEMORY FUNCTIONS

You can use the memory to store frequently used text. These text files remain in the memory, even after the Clear function is used to remove all characters from the display.

When each file is stored, it is given a number to make recalling easier. Up to 99 text files and as many as 2,000 characters can be stored in the memory. Since a copy of the stored text file is recalled when the Recall function is used, it can be edited or printed without changing the original file. When a file is no longer needed or more space is needed, you can use the M.Del function to delete it.

To store a text file:

1 Hold down **Code** and press **Store**.

2 Press **Home** or **End** to choose a file number between 0 and 99.

 If a text file has already been stored under the selected file number, you can see the rest of the file by pressing **Left Arrow** or **Right Arrow**.

3 Press **New Block** to save the file so that it can be recalled at any time.

 If 100 text files which contain less than 2,000 characters have already been stored, the message "OVERWRITE?" appears in the display. If this occurs, an existing text file must be deleted before the new one can be stored.

If a file is already stored under the selected number, the message "OVERWRITE?" appears in the display and you must decide whether or not to overwrite it (delete it and store the new one).

To overwrite the stored file with the new one:

● Press **New Block** to store the new file under the selected number and delete the previously stored one.

 To quit the Store function without storing your text, press **Clear** or hold down **Code** and press **Store**.

To recall a text file:

1 Hold down **Code** and press **Recall**. The number and the first characters of the most recently stored or recalled file are displayed.

2 Press **Home** or **End** until the file you want to recall is displayed.

 To scan through the text file that is displayed, press **Left Arrow** or **Right Arrow**.

3 Press **New Block**.

 If no text has been entered in the display, the file is now recalled. If some text has already been entered in the display, "JOINING" appears and you must decide whether you want to join or overwrite the display text with the recalled file.

To join the recalled file with the display text:

- 1 Press or until "ON" is displayed.
 If you choose "OFF", the stored text file will be recalled to overwrite the display text.
- 2 Press . The stored text file is recalled and inserted in a new block at the cursor's position.
 To quit the Recall function without recalling the text file, press or hold down and press .

To delete a text file:

- 1 Hold down and press .
- 2 Press or until the file that you want to delete is displayed.
 To scan through the text file that is displayed, press or .
- 3 Press . The message "OK TO CLEAR?" is displayed.
- 4 Press to delete the file that was displayed.

EXAMPLE

To store text in file number 8:

- 1 Hold down and press once.

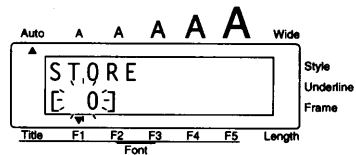

- 2 Press or until file number 8 is displayed.

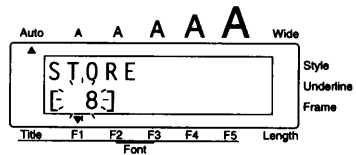

- 3 Press .

To recall the text from file number 4:

- 4 Hold down **Code** and press **Recall** once.

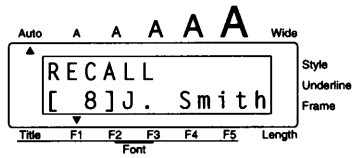

- 5 Press **Home** or **End** until file number 4 is displayed.

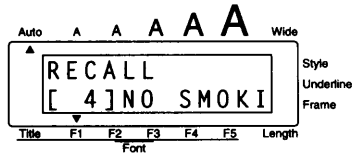

- 6 Press **New Block**.

To delete file number 8:

- 7 Hold down **Code** and press **M.Del** once.

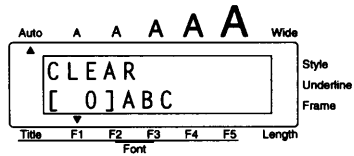

- 8 Press **Home** or **End** until file number 8 is displayed.

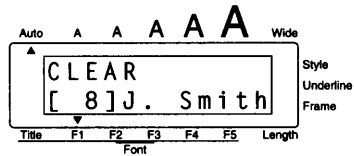

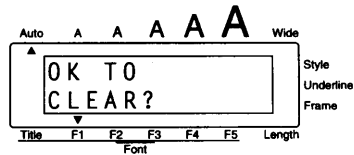

- 9 Press **New Block**.









- 10 Press **New Block**.

TROUBLESHOOTING

Problem	Remedy
1. The display stays blank after you have turned on the machine.	<ul style="list-style-type: none"> • Check that the AC adaptor is connected correctly. • If you are using alkaline batteries, check that they are correctly inserted. • If the batteries are low, replace them.
2. The machine does not print or the printed characters are blurred.	<ul style="list-style-type: none"> • Check that the tape cassette has been inserted properly. • If the tape cassette is empty, replace it with a new one. • Make sure that the tape cassette cover has been closed.
3. The printed characters are not formed properly.	<ul style="list-style-type: none"> • If you are using alkaline batteries, they may be low. Try using the AC adaptor.
4. A blank horizontal line appears through the printed label.	<ul style="list-style-type: none"> • There may be some dust on the print head. Remove the tape cassette and use a dry cotton swab to gently wipe the print head (see page 9) with an up-and-down motion. • If dust still remains, dip the cotton swab in isopropyl (rubbing) alcohol and gently wipe the print head again.
5. Striped tape appears.	<ul style="list-style-type: none"> • You have reached the end of the tape. Replace the tape cassette with a new one.
6. The machine has "locked up" (i.e. it does not respond when a key is pressed).	<ul style="list-style-type: none"> • Turn off the machine, then while holding down  and , turn the machine back on. The text and formats in the display and all text files stored in the memory are erased.

ERROR MESSAGE LIST

Error Message	Cause	Remedy
4 DIGIT MIN.	<ul style="list-style-type: none"> This message appears when less than the minimum four digits are entered in a bar code. 	<ul style="list-style-type: none"> Enter a minimum of four digits before pressing .
4 LINE LIMIT!	<ul style="list-style-type: none"> This message appears if four lines already exist when you press  or if you try to join a text file recalled from the memory to the current message, causing the block to exceed the four line limit. This message appears if the cursor is positioned at the beginning of a block when you press  to join two blocks, resulting in a block containing a total of more than four lines. 	<ul style="list-style-type: none"> Limit the number of lines in the current block to four and press . Adjust the total number of lines in the two blocks so that they will have no more than four lines after they are joined, otherwise do not try to join the two blocks.
5 BARS LIMIT!	<ul style="list-style-type: none"> This message appears if five bar codes already exist when you press  or if you try to join a text file recalled from the memory to the current message, causing the number of bar codes to exceed the five bar limit. 	<ul style="list-style-type: none"> Limit the number of bar codes in the text message to five.

Error Message	Cause	Remedy
5 BLOCK LIMIT!	<ul style="list-style-type: none"> This message appears if five blocks already exist when you press  or if you try to join a text file recalled from the memory to the current message, causing the message to exceed the five block limit. 	<ul style="list-style-type: none"> Limit the number of blocks in the text message to five.
ABCD AT BEGIN&END	<ul style="list-style-type: none"> This message appears when the CODABAR bar code protocol is used, but a letter between A and D has not been entered at the beginning and end of the bar code. 	<ul style="list-style-type: none"> Enter a letter between A and D at the beginning and end of the bar code.
BATTERIES WEAK!	<ul style="list-style-type: none"> This message appears when the installed alkaline batteries become weak. 	<ul style="list-style-type: none"> Replace the batteries or use the AC adaptor.
BUFFER EMPTY!	<ul style="list-style-type: none"> This message appears if you press some function keys, but no text has been entered in the display. This message appears if you try to print, but no text has been entered in the display. This message appears if you try to store a message as a text file, but no text has been entered in the display. 	<ul style="list-style-type: none"> Enter some text before starting the function. Enter text before printing. Enter text before storing.

Error Message	Cause	Remedy
BUFFER FULL!	<ul style="list-style-type: none"> • This message appears if you try to enter a character, symbol, bar code return, new block or space when 255 characters have already been entered in the display. • This message appears if you try to join a text file recalled from the memory to the current message when the display is already full. 	<ul style="list-style-type: none"> • Delete some existing text so that more text can be entered. • Delete some of the text before joining the recalled file to the current message.
CAN'T HERE!	<ul style="list-style-type: none"> • This message appears if a character, symbol, space, return or new block is entered while the cursor is located in a bar code field. • This message appears if a text file is recalled and joined to the current message while the cursor is located in a bar code field. 	<ul style="list-style-type: none"> • Move the cursor or delete the bar code field before entering the character, symbol, return or new block. • Move the cursor or delete the bar code field before recalling the text file.
CHANGE ADAPTOR	<ul style="list-style-type: none"> • This message appears if a high-voltage adaptor is being used. 	<ul style="list-style-type: none"> • Remove the high-voltage adaptor and connect the adaptor designed exclusively for this machine.
FIXED SIZE!	<ul style="list-style-type: none"> • This message appears if <small>New Block</small>  is pressed while a Title font is selected. • This message appears if a 1/4" (6-mm)- or 3/8" (9-mm)-wide tape is installed while a Title font is selected. • This message appears if you try to change the character size while a Title font is selected. 	<ul style="list-style-type: none"> • Change the font. • Insert a tape cassette that is wide enough for Title font text to be printed on it. • Since the size is fixed, do not change it.

Error Message	Cause	Remedy
INPUT WHOLE CODE	<ul style="list-style-type: none"> This message appears if the set number of digits are not entered while inputting the bar code data. 	<ul style="list-style-type: none"> Input the correct number of digits or change the number of digits set in the bar code parameters.
INVAL. CHRS!	<ul style="list-style-type: none"> This message appears if any characters other than letters and numbers are selected in the numbering field. 	<ul style="list-style-type: none"> Only select letters and numbers in the numbering field.
LENGTH LIMIT!	<ul style="list-style-type: none"> This message appears if a character, bar code, space, return or new block is entered, causing the text to exceed the one meter limit. 	<ul style="list-style-type: none"> Delete some of the text or reduce the character size.
LINE LIMIT!	<ul style="list-style-type: none"> This message appears if the number of lines in the text is greater than the maximum number of lines possible for the installed tape. 	<ul style="list-style-type: none"> Reduce the number of lines or install a tape of greater width.
MEMORY FULL!	<ul style="list-style-type: none"> This machine can store about 2,000 characters in its memory. This message appears when you try to store a message that is too large to fit in the available memory space. 	<ul style="list-style-type: none"> Stop trying to store the message or delete an unwanted file to make room for the new one.
NO FILES!	<ul style="list-style-type: none"> This message appears if you try to recall or delete a text file from the memory when none are currently stored. 	<ul style="list-style-type: none"> Store a text file first.
NO TAPE!	<ul style="list-style-type: none"> This message appears if you try to print a label or feed the tape when a tape cassette is not installed. 	<ul style="list-style-type: none"> Install a tape cassette and try again.

Error Message	Cause	Remedy
RAM PROBLEM!	<ul style="list-style-type: none"> • This message appears if there is a problem with the machine's random access memory. 	<ul style="list-style-type: none"> • Contact your service representative.
REPLACE BATTERIES!	<ul style="list-style-type: none"> • This message appears when the installed alkaline batteries are about to run out. 	<ul style="list-style-type: none"> • Replace the batteries or use the AC adaptor.
ROM PROBLEM!	<ul style="list-style-type: none"> • This message appears when there is a problem with the machine's read only memory. 	<ul style="list-style-type: none"> • Contact your service representative.
SYSTEM ERROR!	<ul style="list-style-type: none"> • This message appears if there is a problem with the machine's software. 	<ul style="list-style-type: none"> • Contact your service representative.
TEXT TOO HIGH!	<ul style="list-style-type: none"> • This message appears if the size of the text is larger than the width of the installed tape. 	<ul style="list-style-type: none"> • Reduce the size of the characters or install a tape of greater width.
TEXT TOO LONG!	<ul style="list-style-type: none"> • This message appears if the length of the text is longer than the label length that has been set. 	<ul style="list-style-type: none"> • Delete some of the text, reduce the character width or increase the pre-set label length.
WRONG SELECT	<ul style="list-style-type: none"> • This message appears if more than five characters are selected as the numbering field. 	<ul style="list-style-type: none"> • Limit the numbering field to five characters.

SPECIFICATIONS

HARDWARE

Input Device:	Keyboard - 51 keys
LCD:	7 × 5 dots 12 characters × 2 line 19 indicators
Print Tape:	Pressure-sensitive, adhesive-based 26' 3" (8 m) long Five widths available: 1/4" (6 mm) 3/8" (9 mm) 1/2" (12 mm) 3/4" (18 mm) 1" (24 mm)
Power Supply:	Six AA alkaline batteries (AM3, LR6) or optional AC adaptor Auto power-off if no key is pressed for 5 minutes
Print Head:	128 dot / 180 dpi
Dimensions:	7" (W) × 8 1/16" (D) × 2 23/63" (H) (178 × 205 × 60 mm)
Weight:	24.5 oz. (700 g) (without a tape cassette and batteries installed)

SOFTWARE

Buffer Size:	Maximum 255 characters Single line - 1 m Maximum four lines Maximum five blocks
Memory Size:	2,000 characters
Character Size:	Five sizes (10, 13, 19, 26 and 38 points) + AUTO All are available in normal and WIDE
Character Fonts:	PT-330: Five built-in typefaces PT-350: Eight built-in typefaces
Print Styles:	Normal, Bold, Outline, Solid, Shadow, Outline + Shadow (all can be combined with Italic)

ACCESSORIES

● Supplies

Obtain tape cassettes, AC adaptors and tape cutters from your nearest authorized dealer. Brother cannot be held responsible for trouble caused by the use of unauthorized supplies.

Use only Brother TZ tapes with this machine. Do not use tapes that do not have the **TZ** mark.

Stock No.	Description	QTY/ PACKAGE	PRICE
1" (24mm) laminated tapes			
TZ-151	Black Characters on Clear Adhesive	1	\$23.95
TZ-251	Black Characters on White Adhesive	1	\$23.95
TZ-451	Black Characters on Red Adhesive	1	\$23.95
TZ-651	Black Characters on Yellow Adhesive	1	\$23.95
TZ-252	Red Characters on White Adhesive	1	\$23.95
TZ-354	Gold Characters on Black Adhesive	1	\$26.95
TZ-355	White Characters on Black Adhesive	1	\$26.95
3/4" (18mm) laminated tapes			
TZ-141	Black Characters on Clear Adhesive	1	\$20.95
TZ-241	Black Characters on White Adhesive	1	\$20.95
TZ-242	Red Characters on White Adhesive	1	\$20.95
TZ-243	Blue Characters on White Adhesive	1	\$20.95
TZ-344	Gold Characters on Black Adhesive	1	\$24.95
TZ-345	White Characters on Black Adhesive	1	\$23.95
TZ-441	Black Characters on Red Adhesive	1	\$20.95
TZ-541	Black Characters on Blue Adhesive	1	\$20.95
TZ-545	White Characters on Blue Adhesive	1	\$23.95
TZ-641	Black Characters on Yellow Adhesive	1	\$20.95
TZ-741	Black Characters on Green Adhesive	1	\$20.95
TZ-B41	Black Characters on Orange Fluorescent Adhesive	1	\$24.95
TZ-M41	Black Characters on Clear (matte) Adhesive	1	\$20.95
1/2" (12mm) laminated tapes			
TZ-131	Black Characters on Clear Adhesive	1	\$16.95
TZ-231	Black Characters on White Adhesive	1	\$17.95
TZ-232	Red Characters on White Adhesive	1	\$17.95
TZ-335	White Characters on Black Adhesive	1	\$20.95
3/8" (9mm) laminated tapes			
TZ-121	Black Characters on Clear Adhesive	1	\$14.95
TZ-221	Black Characters on White Adhesive	1	\$16.95
TZ-325	White Characters on Black Adhesive	1	\$18.95
TZ-421	Black Characters on Red Adhesive	1	\$16.95

Stock No.	Description	QTY/ PACKAGE	PRICE
1/4" (6mm) laminated tapes			
TZ-111	Black Characters on Clear Adhesive	1	\$12.95
TZ-211	Black Characters on White Adhesive	1	\$14.95
TZ-315	White Characters on Black Adhesive	1	\$17.95

Special tapes

Stock No.	Description	QTY/ PACKAGE	PRICE
TZ-SE4	Black characters on 3/4" (18 mm) Security Adhesive	1	\$29.95
TZ-FA3	Blue characters on 1/2" (12 mm) Fabric Adhesive	1	\$24.95

STAMP KIT

Stock No.	Description	QTY/ PACKAGE	PRICE
SK-LB	Stamp Making Kit for Large Black	1	\$39.95
SK-MB	Stamp Making Kit for Medium Black	1	\$37.95
SH-LB	Additional Stamper for Large Black	1	\$27.95
SH-MB	Additional Stamper for Medium Black	1	\$24.95

OPTIONS

Stock No.	Description	QTY/ PACKAGE	PRICE
AD-60	AC Adapter for PT-330/350	1	\$24.95

SUPPLIES ORDER FORM

Dear Customer:

Please send this order form along with proper payment to the address below. Visa card, MasterCard, American Express or Discover card holders: Call 1-888-879-3232 toll-free anytime or fax your completed order form to 1-800-947-1445.

Stock No.	Description	Price	Quantity	Total

Name: _____ **Accessory Subtotal:** \$ _____

Address: _____ AZ, CA, CO, CT, FL, GA, IL, LA, MA, MD,

City: _____ MI, MN, MO, NC, NJ, NV, NY, OH, PA, TN,

State/Zip: _____ TX, VA, WA

residents add applicable sales tax \$ _____

Daytime Phone: _____

Shipping/Handling Options
Please choose one:

SEND ORDER FORM TO:

Brother International Corp.
Attn: Consumer Accessory Div.
P.O. Box 341332
Bartlett, TN38184-1332

- Standard (\$5.00)
- 2nd day air freight (\$8.75)
Mandatory for all deliveries
outside of the continental U.S.
(Alaska, Hawaii, Puerto Rico,
Virgin Islands & Canada)
- All other overseas orders (\$25.00) \$ _____

TOTAL DUE (US dollars) \$ _____

Method of payment (Check one)

() Visa () MasterCard () Discover () American Express () Check/Money Order

Account Number _____

Expiration Date _____

Signature _____

* Prices subject to change without notice.

SUPPLIES ORDER FORM

Dear Customer:
 Please send this order form along with proper payment to the address below. Visa card, MasterCard, American Express or Discover card holders: Call 1-888-879-3232 toll-free anytime or fax your completed order form to 1-800-947-1445.

Stock No.	Description	Price	Quantity	Total

Name: _____ **Accessory Subtotal:** \$ _____

Address: _____ AZ, CA, CO, CT, FL, GA, IL, LA, MA, MD,
 City: _____ MI, MN, MO, NC, NJ, NV, NY, OH, PA, TN,
 TX, VA, WA

State/Zip: _____ residents add applicable sales tax \$ _____

Daytime Phone: _____ **Shipping/Handling Options**

SEND ORDER FORM TO:

Brother International Corp.
 Attn: Consumer Accessory Div.
 P.O. Box 341332
 Bartlett, TN38184-1332

- Please choose one:
- Standard (\$5.00)
 - 2nd day air freight (\$8.75)
 Mandatory for all deliveries
 outside of the continental U.S.
 (Alaska, Hawaii, Puerto Rico,
 Virgin Islands & Canada)
 - All other overseas orders (\$25.00) \$ _____

TOTAL DUE (US dollars) \$ _____

Method of payment (Check one)

() Visa () MasterCard () Discover () American Express () Check/Money Order

Account Number _____

Expiration Date _____

Signature _____

* Prices subject to change without notice.

***GUIA DE
INSTRUCCIONES***

A 3D perspective drawing of a book cover. The cover is white with a black border. The text "GUIA DE INSTRUCCIONES" is printed in a bold, italicized, serif font. The bottom right corner of the cover is curled up, revealing a dark, shaded underside. The book is shown from a slightly elevated angle, giving it a three-dimensional appearance.

INTRODUCCION

Gracias por adquirir una P-Touch 330/350.

Su nueva P-Touch le permitirá diseñar y crear etiquetas y membretes para cualquier tipo de aplicación. Su versatilidad le permitirá crear etiquetas personales seleccionando distintos diseños de marcos y muchos tamaños y estilos de caracteres. Además, los cuatro diferentes anchos de cinta (1/4" (6 mm), 3/8" (9 mm), 1/2" (12 mm), 3/4" (18 mm) y 1" (24 mm)) y la variedad de los colores de la cintas le hará posible imprimir etiquetas personales, útiles para relleno con código de colores. Con la función de membretes, podrá hacer membretes con facilidad y rapidez para soportes de membretes entintados reutilizables.

Ya no hay por qué preocuparse por tareas urgentes que requieren impresión profesional. En la oficina, la fábrica, el laboratorio, o en casa, la calidad y el rendimiento de la P-Touch 330/350 la convierten en una máquina muy práctica.

Para terminar, puesto que esta guía del usuario le será de gran utilidad, le aconsejamos que la guarde en un lugar accesible para poder consultar en cualquier momento.

AVISO DE LA FCC

Este equipo ha sido probado y cumple con los límites de un aparato digital de la Clase B, siguiendo el apartado 15 de las normas de la FCC. Estos límites están pensados para proporcionar una protección razonable contra interferencias nocivas dentro de una instalación residencial. Este equipo podría interferir de forma nociva con comunicaciones por radio si no se instala y utiliza siguiendo las instrucciones. No obstante, no existe ninguna garantía de que no vayan a suceder interferencias en una instalación concreta. Si este equipo causara interferencias nocivas con la recepción de radio o televisión, lo cual puede determinarse poniendo el equipo en ON u OFF, se recomienda que el usuario intente corregir dichas interferencias mediante una de las siguientes medidas:

- Reoriente o ponga la antena receptora en otro lugar.
- Aumente la separación entre el equipo y el receptor.
- Conecte el equipo en una toma de un circuito diferente de la que esté conectada el receptor.
- Consulte a su distribuidor o a un técnico experimentado de radio/televisión.

A continuación se indican los números de patente y de publicación de patente relacionados con este producto:

USP4839742	USP4983058	USP5120147
USP4927278	USP5009530	
USP4976558	USP5069557	

ÍNDICE

PRECAUCIONES GENERALES.....	1
PILAS	2
ADAPTADOR DE CA OPCIONAL	3
CASSETES DE CINTA	4
CABEZAL DE IMPRESIÓN Y RODILLOS	5
TECLA DEL CURSOR	6
TECLAS CODE, ALT Y SHIFT	8
TECLA DE RETORNO	9
FUNCIÓN DE NUEVO BLOQUE (NEW BLOCK)	10
TECLA DE BORRADO (DEL)	10
FUNCIÓN DE BORRADO DE LÍNEA (LINE OUT).....	11
FUNCIÓN DE REPOSICIÓN (CLEAR)	11
TECLAS DE CARACTERES COMPUESTOS	12
FUNCIÓN DE ACENTOS.....	13
FUNCIÓN DE SÍMBOLOS	14
FUNCIÓN DE LONGITUD	15
FUNCIÓN DE MEMBRETE.....	17
FUNCIONES DE TAMAÑO Y DE ANCHURA	18
FUNCIÓN DE ESTILO.....	19
FUNCIÓN DE SUBRAYADO	20
FUNCIÓN DEL TIPO DE CARACTERES	21
FUNCIÓN DE MARCOS	23
FUNCIÓN DE CINTA	25
FUNCIÓN DE LA ALINEACIÓN HORIZONTAL	26
FUNCIÓN DE IMPRESIÓN VERTICAL	27
FUNCIÓN DE IMPRESIÓN DE ESPEJO	27
FUNCIÓN DE CÓDIGOS DE BARRAS	28
FUNCIÓN DE LA TECLA DE IMPRESIÓN Y AVANCE.....	30
FUNCIÓN DE NUMERACIÓN.....	31
FUNCIÓN DE IMPRESIÓN REPETIDA	32
FUNCIÓN DE CALENDARIO	33
FUNCIONES DE LA MEMORIA	34
SOLUCIÓN DE PROBLEMAS.....	36
LISTA DE MENSAJES DE ERROR	37
ESPECIFICACIONES	43
ACCESORIOS	44

PRECAUCIONES GENERALES

- Con esta máquina emplee sólo cintas TZ Brother. No emplee cintas que no tengan la marca .
- No tire de la cinta que se alimenta desde la P-Touch. Podría dañar el casete de cinta.
- No emplee la máquina en lugares demasiado polvorientos. Manténgala apartada de la luz directa del sol y de la lluvia.
- No exponga la máquina a altas temperaturas ni humedad. No la deje nunca en el tablero de instrumentos ni en la parte trasera de su automóvil.
- No deje nada que sea de goma o vinilo encima de la máquina durante períodos prolongados. Podría producir manchas.
- No limpie la máquina con alcohol ni con otros solventes orgánicos. Emplee solamente un paño suave y seco.
- No ponga ningún objeto encima de la máquina.
- Para evitar daños, no toque el borde de la cuchilla.
- Cuando inserte pilas nuevas, asegúrese de hacerlo antes de que transcurran cinco minutos desde el momento en que extrae las pilas gastadas, porque de lo contrario se perderían todos los archivos de texto (a menos que la máquina esté enchufada a una toma de CA con el adaptador de CA).
- Emplee sólo el adaptador de CA (modelo AD-60) exclusivamente diseñado para esta máquina. El empleo de otro cancelaría la garantía.
- No intente desmontar el adaptador de CA.
- Cuando la máquina no se utilice durante períodos prolongados de tiempo y no sea necesario conservar los archivos de texto en la memoria, desenchufe el adaptador de CA, y saque las pilas para evitar fugas de las mismas que podrían ser causa de daños en la máquina.
- Cuando el adaptador de CA esté enchufado en la máquina, si se desenchufa el adaptador de la toma de CA se correrá el riesgo de perder todos los archivos de texto de la memoria, aunque las pilas estén insertadas.
- **En esta máquina, emplee seis pilas alcalinas del tamaño AA.**

PILAS

Esta máquina ligera y portátil puede utilizarse en cualquier lugar instalando seis (6) **pilas alcalinas AA**. Cuando cambie las pilas, reemplace siempre las seis pilas al mismo tiempo.

Para cambiar las pilas:

- 1 Extraiga la cubierta del compartimiento de las pilas de la parte posterior de la máquina.
- 2 Si ya hay pilas instaladas, extráigalas.
- 3 Inserte seis pilas alcalinas AA nuevas, asegurándose de que quedan orientadas en la dirección correcta.
- 4 Coloque la cubierta del compartimiento de las pilas.

 *Asegúrese de insertar las pilas nuevas antes de que transcurran cinco minutos desde que se extraen las pilas gastadas, porque de lo contrario el texto que se visualiza en la pantalla y los archivos de texto almacenados en la memoria se perderían (a menos que la máquina esté enchufada a una toma de CA con el adaptador de CA).*

Extraiga las pilas y desconecte el adaptador de CA si no se propone utilizar la máquina durante períodos de tiempo prolongados. Cuando se desconecta la alimentación, se pierden el texto que se muestra en la pantalla y el que está almacenado en la memoria.

Si no se emplean pilas alcalinas, no podrán imprimirse tipos de caracteres grandes ni códigos de barras.

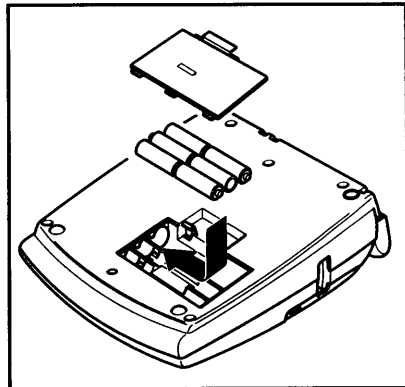
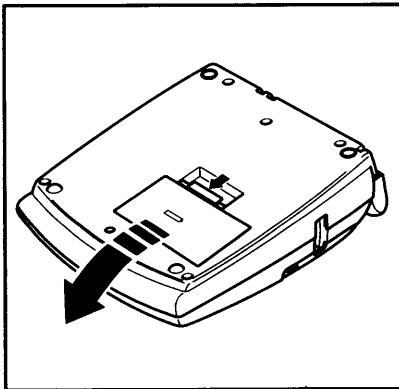

ADAPTADOR DE CA OPCIONAL

El adaptador de CA (modelo AD-60) le permite emplear esta máquina siempre que disponga de una toma de corriente eléctrica.

Para conectar el adaptador de CA opcional:

- 1 Inserte la clavija del adaptador en el conector que tiene la marca DC IN 9.5V al lado derecho de la máquina.
- 2 Inserte la clavija del adaptador de CA en la toma de corriente más cercana.

 *Emplee sólo el adaptador de CA diseñado exclusivamente para esta máquina.*

Extraiga las pilas y desconecte el adaptador de CA si no se propone utilizar la máquina durante períodos de tiempo prolongados. Cuando se desconecta la alimentación, se pierden el texto que se muestra en la pantalla y el que está almacenado en la memoria.

Se recomienda emplear el adaptador de CA para imprimir tipos de caracteres grandes y códigos de barras con cintas de 18 mm (3/4") o de 24 mm (1") porque estas operaciones pueden gastar las pilas con rapidez.

Para hacer membretes grandes, emplee un adaptador de CA (modelo AD-60). Si se crean membretes grandes empleando las pilas, es posible que la calidad del membrete sea insatisfactoria.

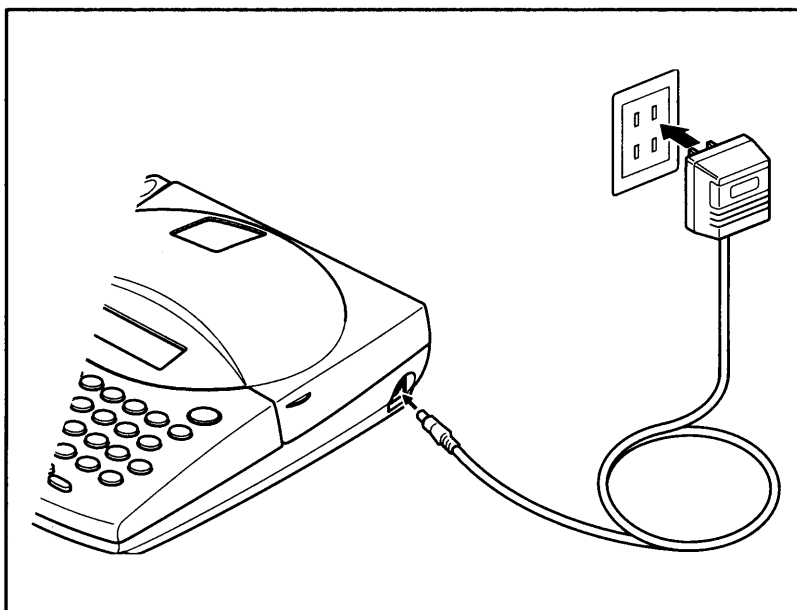

CASETES DE CINTA

Un casete de TZ se suministra con la unidad. Sin embargo, para esta máquina hay disponibles una amplia gama de casetes de cinta TZ de distintos colores y tamaños, es posible crear etiquetas diferentes codificadas por colores o tamaños.

Para cambiar el casete de cinta:



- 1 Levante la cubierta del compartimiento de la cinta para abrirla. Se libera también entonces el casete instalado.
- 2 Si ya hay un casete instalado, extráigalo tirando del mismo recto hacia arriba.
- 3 Extraiga el tope del casete de cinta nuevo.

 Asegúrese de que el extremo de la cinta se alimenta por debajo de las guías de cinta.

Si la cinta entintada del casete está floja, bobine la rueda dentada con el dedo en la dirección de la flecha hasta que la cinta quede tensada. Si emplea un casete de cinta usado, asegúrese de que la cinta esté tensa antes de insertarla en la unidad.

- 4 Inserte firmemente el casete de cinta en el compartimiento de la cinta asegurándose de que toda la parte posterior del casete está en contacto con la inferior del compartimiento.

 Cuando inserte el casete de cinta, asegúrese de que la cinta interior no esté enganchada en la esquina de la guía metálica.

- 5 Cierre la cubierta del compartimiento y conecte la alimentación de la máquina si estaba desconectada.
- 6 Mantenga pulsada  y presione  una vez para que la cinta avance y así quede con la tensión óptima.
- 7 Presione la palanca de la cuchilla de la cinta para cortar la cinta sobrante.

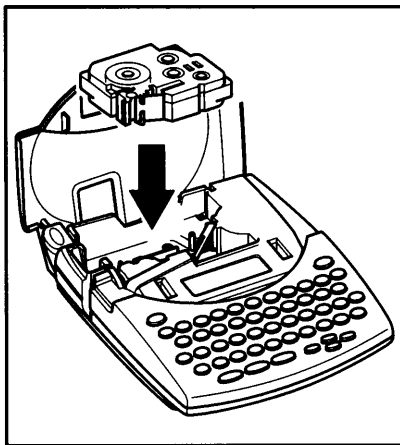
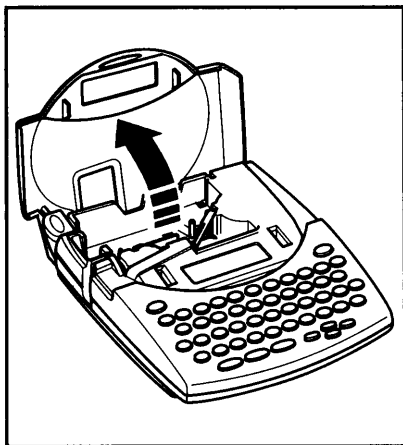

CABEZAL DE IMPRESIÓN Y RODILLOS

De vez en cuando, motas de polvo o suciedad se adhieren al cabezal de impresión y a los rodillos de la máquina. Suele suceder cuando se emplea la unidad en exteriores o en lugares con mucho polvo. Si alguna parte del cabezal de impresión está cubierta de polvo, es posible que aparezca una franja horizontal blanca por el texto de la etiqueta.

Por lo tanto, al igual que con las grabadoras de cintas, el cabezal de la máquina deberá limpiarse de vez en cuando.

Para limpiar el cabezal de impresión y los rodillos:

- 1 Desconecte la alimentación de la máquina.
- 2 Abra la cubierta del compartimiento de la cinta, extraiga el casete, si está dentro. El cabezal de impresión y los rodillos están situados dentro del compartimiento de la cinta.
- 3 **Cabezal de impresión:** Emplee un palillo con punta de algodón seco para frotar con cuidado el cabezal de impresión con movimiento hacia arriba y abajo.
Rodillos: Emplee un palillo con punta de algodón seco para frotar cada rodillo con movimiento hacia arriba y abajo mientras los gira con el dedo.
- 4 Pruebe de nuevo la impresión.

Si todavía queda polvo:

- 5 Repita el paso 3 empleando un palillo con cabeza de algodón humedecido en alcohol isopropílico (limpieza).

Si no funciona nada de lo de arriba, póngase en contacto con el representante de servicio.

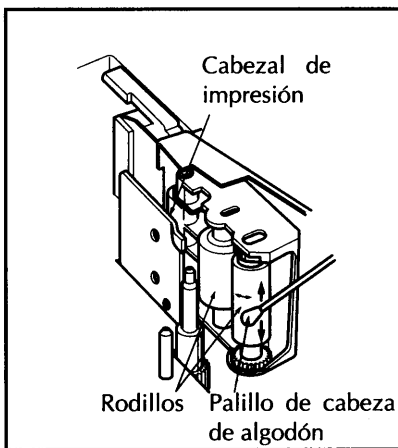
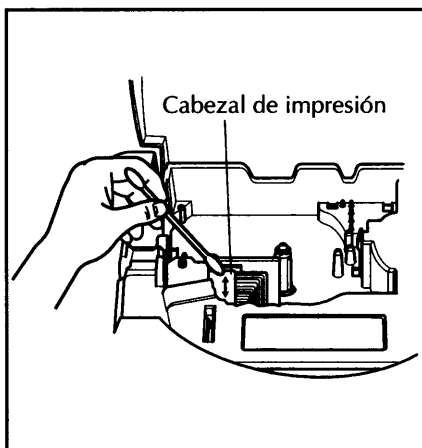

TECLA DEL CURSOR

El visualizador de LCD de esta máquina muestra dos filas de 11 caracteres; sin embargo, el texto que usted cree puede tener hasta 255 caracteres de longitud. Podrá revisar y editar el texto empleando las teclas del cursor para moverlo y que muestre las distintas partes en el visualizador.

TECLA DEL CURSOR IZQUIERDA



Para mover el cursor un carácter hacia la izquierda:

- Presione  una vez.



Para mover el cursor varios caracteres hacia la izquierda:

- Mantenga presionado  hasta que el cursor se mueva a la posición deseada.

Para mover el cursor al principio de la línea actual:

- Mantenga presionado  y presione .

Para mover el cursor al principio del bloque de texto actual:

- Mantenga presionado  y presione .

 *Si el cursor está al principio de un bloque de texto, se moverá al principio del bloque anterior.*

TECLA DEL CURSOR DERECHA

Para mover el cursor un carácter hacia la derecha:

- Presione  una vez.



Para mover el cursor varios caracteres hacia la derecha:

- Mantenga presionado  hasta que el cursor se mueva a la posición deseada.

Para mover el cursor al final de la línea actual:

- Mantenga presionado  y presione .

Para mover el cursor al principio del bloque de texto siguiente:

- Mantenga presionado  y presione .

 *Si el cursor está en el último bloque de texto, se moverá al final del texto.*

TECLA DEL CURSOR HACIA ARRIBA

Para mover el cursor a la línea anterior:



- Presione  una vez.

 Si el cursor está en la primera línea del texto, se moverá al principio de la línea.

Para mover el cursor varias líneas hacia arriba:

- Mantenga presionado  hasta que el cursor se mueva a la posición deseada.

Para mover el cursor al principio de todo el texto:

- Mantenga presionado  y presione .

TECLA DEL CURSOR HACIA ABAJO

Para mover el cursor a la línea siguiente:

- Presione  una vez.

 Si el cursor está en la última línea del texto, se moverá al final de la línea.

Para mover el cursor varias líneas hacia abajo:

- Mantenga presionado  hasta que el cursor se mueva a la posición deseada.

Para mover el cursor al final de todo el texto:

- Mantenga presionado  y presione .

TECLAS CODE, ALT Y SHIFT

La mayoría de los caracteres pueden introducirse simplemente presionando sus teclas. Sin embargo, para emplear funciones especiales o para introducir letras en mayúsculas, caracteres acentuados y algunos símbolos, se requieren las siguientes teclas especiales.



TECLA CODE

Para emplear una función impresa encima de la tecla:

- Mantenga presionado  y presione la tecla que está inmediatamente debajo de la función deseada.

TECLA ALT

Para escribir los caracteres impresos en color del lado derecho de las teclas:

- Mantenga presionado  y presione la tecla del carácter deseado escrita en color. El indicador Alt, de la izquierda del visualizador, se encenderá mientras se tiene presionado .





TECLA SHIFT

Para escribir una letra mayúscula o un símbolo impreso en la esquina superior izquierda de la tecla:

- Mantenga presionado  y presione la tecla de la letra o símbolo deseado.

El modo Caps (mayúsculas) es similar a mantener presionada la tecla Shift. Le permite escribir letras mayúsculas continuamente.

Para escribir muchas letras mayúsculas:

- 1 Mantenga presionado  y presione . El indicador de Caps, de la izquierda del visualizador, se encenderá.
- 2 Presione las teclas de las letras o símbolos deseados.
- 3 Para salir del modo Caps, mantenga presionado  y presione . Se apagará el indicador de Caps.

TECLA DE RETORNO



Al igual que en una máquina de escribir o procesador de texto, la tecla de retorno () de esta máquina se emplea para poner fin a una línea de texto y empezar otra. Cuando haya terminado de introducir una línea, presione la tecla de retorno para hacer una línea nueva y mover al cursor a la misma.

 *Un bloque sólo puede contener una línea de texto cuando se emplea un tipo de caracteres para títulos. Si presiona  cuando tiene seleccionado un tipo de caracteres para títulos, aparecerá el mensaje de error "FIXED SIZE!".*

Un bloque sólo puede contener un máximo de cuatro líneas de texto. Si presiona  cuando el cursor está situado en la cuarta línea, aparecerá el mensaje de error "4 LINE LIMIT!".



Anchuras de cinta	Número máximo de líneas que pueden imprimirse
1/4" (6 mm)	1
3/8" (9 mm)	2
1/2" (12 mm)	2
3/4" (18 mm)	4
1" (24 mm)	4



La tecla de retorno también puede utilizarse para aplicar un ítem seleccionado (por ej., para añadir un símbolo o carácter acentuado al texto) o para empezar a imprimir el número ajustado de etiquetas.

Es posible que aparezcan en el visualizador de LCD algunas preguntas para que confirme un comando, especialmente cuando la función que usted ha seleccionado es para borrar o afectar archivos. En estos casos, si presiona  es como si respondiera "sí". Para contestar "no", presione . Consulte la descripción de la TECLA DE BORRADO (DEL) de la página 10.



FUNCIÓN DE NUEVO BLOQUE (NEW BLOCK)

Siempre que cambia el número de líneas de una sección de la etiqueta, debe crearse un nuevo bloque.



☞ Una misma etiqueta sólo puede contener un máximo de cinco bloques. Si el cursor está situado en el quinto bloque cuando se mantiene presionado  y se presiona , aparece el mensaje de error "5 BLOCK LIMIT".

Si el cursor está situado a mitad de un bloque de texto cuando se mantiene presionado  y se presiona , el bloque se divide en dos y el carácter de la izquierda de la posición actual del cursor pasa a ser el final del bloque.



Para añadir un bloque nuevo:



- Mantenga presionado  y presione  una vez. Aparecerá la marca de nuevo bloque () para indicar el final del bloque.

TECLA DE BORRADO (DEL)





La tecla de borrado () le permite eliminar caracteres situados a la izquierda de la posición actual del cursor. Se diferencia de la tecla del cursor izquierda () que sólo mueve el cursor sin borrar ningún carácter.

La tecla de borrado también puede utilizarse para abandonar la mayor parte de funciones y volver a la visualización anterior sin cambiar el texto.





☞ La tecla de borrado no puede utilizarse para abandonar la función de códigos de barras. Mantenga presionado  y presione  para abandonar la función de códigos de barras.

Es posible que aparezcan en el visualizador de LCD algunas preguntas para que confirme un comando, especialmente cuando la función que usted ha seleccionado es para borrar o afectar archivos. En estos casos, si presiona  es como si respondiera "sí". Para contestar "no", presione . Consulte la descripción de la TECLA DE RETORNO de la página 9.

Para borrar un carácter:

- 1 Presione , , , o  para situar el cursor debajo del carácter que está inmediatamente a la derecha del carácter que usted desea borrar.
- 2 Presione  una vez.









Para borrar una secuencia de caracteres:

- 1 Presione , , , o  para situar el cursor debajo del carácter que está inmediatamente a la derecha del último carácter que usted desea borrar.
- 2 Mantenga presionado  hasta que se hayan borrado todos los caracteres que usted deseaba borrar.











FUNCIÓN DE BORRADO DE LÍNEA (LINE OUT)

Con la función de borrado de línea, podrá sacar con facilidad una línea entera de texto.





Para borrar una línea de texto:

- 1 Presione , , , o  para situar el cursor dentro de la línea del texto que usted desee borrar.
- 2 Mantenga presionado  y presione  una vez.
 Cada vez que se presione  mientras se tiene presionado , se borrará una línea de texto.

FUNCIÓN DE REPOSICIÓN (CLEAR)

La función de reposición se emplea para sacar todos los caracteres del visualizador y reponer todos los formatos de caracteres (seleccionados empleando , , , , y ) y formatos de etiquetas (seleccionados empleando , , , , y ) a sus ajustes iniciales. En otras palabras se vacía por completo el visualizador. Entonces podrá empezar a introducir texto nuevo.

Para borrar todo el texto y reponer todos los formatos a sus ajustes iniciales:

- 1 Mantenga presionado  y presione . Aparecerá el mensaje "OK TO CLEAR?" en el visualizador.
- 2 Presione .
 Para detener el borrado del texto, presione . Consulte la TECLA DE BORRADO (DEL) en la página 10.

TECLAS DE CARACTERES COMPUESTOS

Cuando se escribe en algunos idiomas, se utilizan frecuentemente caracteres compuestos, que constan de una letra y de un signo diacrítico. Esta máquina también puede visualizar e imprimir estos caracteres. Los signos diacríticos disponibles son ^, ¨, ´, y `.

Varios caracteres compuestos pueden encontrarse en la parte superior de las teclas. Los caracteres tales como ü, ç, y ñ pueden introducirse empleando ^{Symbol} (Alt). Antes de introducir un carácter compuesto como se describe abajo, compruebe si es uno de los que están disponibles en la parte superior de las teclas.

Las siguientes combinaciones de signos diacríticos y letras están disponibles:

Signos diacríticos	Letras que pueden combinarse
^	A E I O U a e i o u
¨	A E I O U a e i o u
´	A E I O U a e i o u
`	A E I O U a e i o u

Para escribir un carácter compuesto:

- Mantenga presionado ^{Symbol} (Alt) y presione la tecla (^{Number} (Q), ^{Repeat} (W), ^{Frame} (E), o ^{Stamp} (R)) del signo diacrítico deseado. El signo diacrítico se añade al texto. El indicador Alt, situado a la izquierda del visualizador, se enciende mientras se tiene presionado ^{Symbol} (Alt).
 - Presione la tecla de la letra que desee combinar con el signo diacrítico. La letra y el signo diacrítico parpadearán alternadamente dentro del texto.
-  *Si la letra de la tecla que usted ha presionado no puede combinarse con el signo diacrítico (vea la tabla de arriba), la letra se añade al texto en lugar de la marca diacrítica.*



FUNCIÓN DE ACENTORS





La función de acentos también puede utilizarse para añadir caracteres acentuados al texto. Muchos de estos caracteres pueden introducirse empleando las teclas de caracteres compuestos o pueden encontrarse en las teclas y escribirse empleando . Consulte la TECLAS DE CARACTERES COMPUESTOS en la página 12.







Los caracteres acentuados se agrupan de acuerdo con la letra mayúscula o minúscula con la que se combinan. Hay disponibles los siguientes caracteres acentuados:

Letras	Caracteres acentuados	Letras	Caracteres acentuados
a	ä á à â ã æ	l	l̄ l̇ l̈ l̉
A	Ä Á À Â Ã Æ	n	ñ
c	ç	N	Ñ
C	Ç	o	ö ó ò ô õ
e	ë é è ê ë	O	Ö Ó Ò Ô Õ
E	Ë É Ê Ë Ì	u	ü ú ù û
i	ï í î ï	U	Ü Ú Û Ü

Para escribir un carácter acentuado:

- Mantenga presionado  y presione . Aparecerá el mensaje “a-u/A-U?” en el visualizador.
- Presione la tecla de la letra acentuada deseada.

 Si desea escribir una letra mayúscula, mantenga presionado  mientras presiona la tecla de la letra deseada.
- Presione  o  hasta que parpadee el carácter acentuado.
- Presione . La letra y el acento parpadearán alternadamente en el texto.

 Si desea escribir una secuencia de caracteres acentuados, mantenga presionado  mientras presiona . Siga añadiendo caracteres acentuados al texto seleccionándolos, y manteniendo luego presionado  mientras presiona . Presione solamente  después de seleccionar el último carácter de la secuencia.

FUNCIÓN DE SÍMBOLOS

Además de letras, de los símbolos y los números de las teclas, hay 126 marcas adicionales con la función de símbolos.

Los siguientes símbolos están disponibles:

•	+	×	÷	=	®	©	™	[]	\$	½
🏠	♥	★	♠	♣	Æ	∞	↑	↓	→	←	°
①	②	③	④	⑤	⑥	⑦	⑧	⑨	⑩	±	0
1	2	3	4	5	6	7	8	9	-	+	±
0	1	2	3	4	5	6	7	8	9	-	+
✂	✂	✂	✂	✂	✂	✂	✂	✂	✂	✂	✂
✂	✂	✂	✂	✂	✂	✂	✂	✂	✂	✂	✂
✂	✂	✂	✂	✂	✂	✂	✂	✂	✂	✂	✂
✂	✂	✂	✂	✂	✂	✂	✂	✂	✂	✂	✂
✂	✂	✂	✂	✂	✂	✂	✂	✂	✂	✂	✂
✂	✂	✂	✂	✂	✂	✂	✂	✂	✂	✂	✂
✂	✂	✂	✂	✂	✂	✂	✂	✂	✂	✂	✂

Para escribir un símbolo:

- 1 Mantenga presionado **Code** y presione **Alt**^{Symbol}. Aparecerá una fila de símbolos en el visualizador.
- 2 Presione **Home** o **End** para visualizar distintas filas de símbolos y presione **◀** o **▶** hasta que parpadee el símbolo deseado.
- 3 Presione **New Block**[←]. El símbolo aparecerá en el texto.

🗨️ Si desea escribir una secuencia de símbolos, mantenga presionado **Code** mientras presiona **New Block**[←]. Siga añadiendo símbolos al texto seleccionándolos, y manteniendo presionado entonces **Code** mientras presiona **New Block**[←]. Presione solamente **New Block**[←] después de haber seleccionado el último símbolo de la secuencia.

FUNCIÓN DE LONGITUD



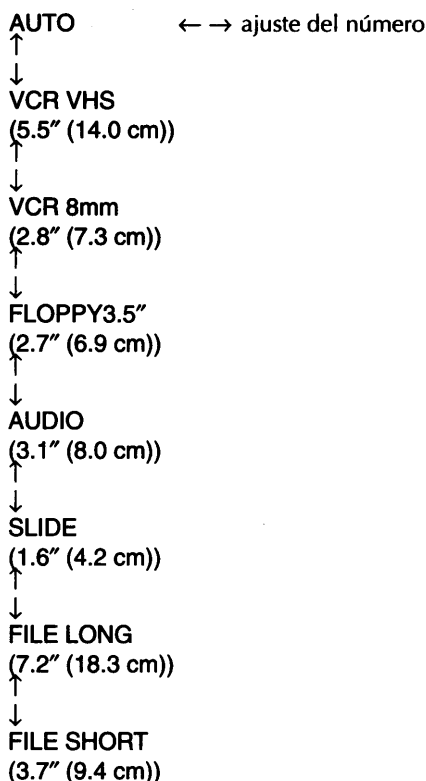

Cuando se selecciona la función de longitud, se visualiza brevemente la longitud del texto y ambos márgenes. Con esta función, podrá ajustar la longitud de la etiqueta entre 3,8 cm (1,5") y 25,4 cm (10,0"), seleccionar entre distintas longitudes preajustadas, o seleccionar AUTO, que ajusta automáticamente la longitud de la etiqueta para adaptarla a su texto.

El ajuste de longitud de ajuste inicial es AUTO. Si se selecciona cualquier otro ajuste que no sea AUTO, se encenderá el indicador de longitud, situado debajo del visualizador.



También hay disponibles las siguientes longitudes preajustadas:







Para ajustar la longitud de la etiqueta:

- 1 Mantenga presionado  y presione  una vez. La longitud de la etiqueta actual aparecerá brevemente en el visualizador.
- 2 Presione  o  para seleccionar AUTO, que le permite seleccionar entre longitudes preajustadas, o ajustes de números, que le permiten introducir una longitud específica.

 Para cambiar el ajuste desde una longitud preajustada a un ajuste de número, seleccione primero AUTO.

③ Presione  o  para seleccionar el ajuste deseado.

 Para cambiar las unidades (pulgadas o centímetros) en que se visualizan las longitudes, seleccione el ajuste del número, y presione entonces  hasta que se visualicen las unidades deseadas.

Para cambiar los valores de números en pasos de 1,0 cm (1"), mantenga presionado  o , y suelte la tecla cuando se visualice el ajuste deseado.

El ajuste inicial (AUTO con una longitud de ajuste inicial de 10,2 cm (4,0")) puede seleccionarse presionando .





④ Presione  para aplicar el ajuste de la longitud seleccionada al texto.

 El indicador de longitud se encenderá si se selecciona algún otro ajuste que no sea AUTO.

FUNCIÓN DE MEMBRETE

La función de membrete le permite crear con rapidez y facilidad sus propios clichés para membretes personalizados. Seleccione esta función para centrar automáticamente el texto y ajustar la longitud de la cinta y los márgenes a un formato perfecto para los soportes de películas de membrete entintados. Puesto que el soporte del membrete es reutilizable, haga un nuevo cliché de membrete y reemplácelo por el que hay en el soporte de películas.

Para hacer un membrete:

- 1 Escriba el texto, y entonces inserte un casete de película de membretes en el compartimiento de la cinta.
 -  *Asegúrese de instalar un casete de película de membretes de 18 mm (3/4") o de 24 mm (1").*
Para hacer membretes grandes, emplee un adaptador de CA (modelo AD-60). Si se crean membretes grandes empleando las pilas, es posible que la calidad del membrete sea insatisfactoria.
- 2 Mantenga presionado  y presione  una vez. Aparecerá el mensaje "STAMP FORMAT" en el visualizador.
- 3 Presione . Se hará el formato del texto para un membrete: centrado dentro del área preajustada del mensaje con la longitud y los márgenes de la cinta automáticamente ajustados.
- 4 Presione  para separar el texto del cliché de membrete.
- 5 Presione la palanca de la cuchilla de la cinta, extraiga el papel del dorso del cliché del membrete y adhiéralo al tampón de tinta o soporte de películas.

Para adherir un membrete:

- 1 Extraiga el marco del membrete de entorno al lado al tampón de tinta del soporte de películas de una vez, y saque entonces el sello protector que cubre el tampón de tinta y el papel del dorso del cliché del membrete.
- 2 Con el lado brillante del cliché del membrete encarado hacia arriba, alinee uno de sus extremos con la ranura del lado del soporte de películas de membrete.
- 3 Retenga el extremo del cliché del membrete en su lugar con el dedo pulgar, y pase la cinta por las guías mientras la tensa bien.
- 4 Pliegue el otro extremo del cliché del membrete por en otro lado del soporte de películas de membrete y reténgalo en su lugar con el dedo.
- 5 Adapte el marco del membrete encima del cliché del membrete y presiónelo a su lugar.
- 6 Inserte el soporte de películas de membrete recto en su tapa.
 -  *Asegúrese de que el membrete quede correctamente cubierto para evitar derrames de tinta.*

FUCIONES DE TAMAÑO Y DE ANCHURA



El tamaño de los caracteres puede ajustarse empleando las funciones de tamaño (Size) y de ancho (Wide). Puesto que el tamaño de los caracteres que puede utilizarse depende del ancho de la cinta, la tabla siguiente indica los tamaños de caracteres que pueden utilizarse con cada ancho de cinta.

Anchos de cinta	Tamaños (en puntos)
1/4" (6 mm)	10, 13
3/8" (9 mm)	10, 13, 19
1/2" (12 mm)	10, 13, 19
3/4" (18 mm)	10, 13, 19, 26, 38
1" (24 mm)	10, 13, 19, 26, 38



El ajuste del tamaño de ajuste inicial es AUTO y el ajuste inicial para el ancho es OFF. El tamaño y el ancho actualmente seleccionados siempre se indican con los indicadores de encima del visualizador.

Con el ajuste de tamaño AUTO, la máquina compara su texto con el ancho de la cinta instalada y ajusta automáticamente los caracteres al tamaño más grande posible. Sin embargo, hay también otros cinco tamaños de puntos disponibles y cada uno puede imprimirse con caracteres anchos.

Para cambiar el ajuste del tamaño:



- 1 Mantenga presionado  y presione  una vez. El ajuste del tamaño actualmente seleccionado aparece en el visualizador.



 *Los indicadores de encima del visualizador también indican el ajuste del tamaño actual.*

- 2 Mantenga presionado  y siga presionando  hasta que aparezca el ajuste deseado en el visualizador y se indique con los indicadores de encima del visualizador.

- 3 Suelte  para aplicar el ajuste del tamaño deseado a todos los caracteres del texto.

Para cambiar el ajuste del ancho:

- 1 Mantenga presionado  y presione  una vez. El ajuste del ancho actualmente seleccionado aparece en el visualizador.

- 2 Mantenga presionado  y siga presionando  hasta que aparezca el ajuste deseado en el visualizador.

- 3 Suelte  para aplicar el ajuste del ancho deseado a todos los caracteres del texto.

 *El indicador del ancho se enciende si se selecciona el ajuste ON.*

FUNCIÓN DE ESTILO

Podrá seleccionar entre doce estilos de caracteres distintos que podrá aplicar a su texto.

 *Los caracteres que se imprimen utilizando los tamaños más pequeños pueden resultar difíciles de leer si se seleccionan ciertos ajustes de estilos (por ejemplo, (I+SHADOW).*





Hay disponibles los siguientes ajustes de estilos:

NORMAL	ITALIC (cursiva)
BOLD (negrilla)	I+BOLD (cursiva y negrilla)
OUTLINE (perfilado)	I+OUTLINE (cursiva y perfilado)
SOLID (sólido)	I+SOLID (cursiva y sólido)
SHADOW (sombreado)	I+SHADOW (cursiva y sombreado)
O+SHADOW (perfilado y sombreado)	I+O+SHADOW (cursiva, perfilado, y sombreado)

El ajuste de estilo de ajuste inicial es NORMAL. Si se selecciona un ajuste que no sea el de NORMAL, se encenderá el indicador de estilo, situado a la derecha del visualizador.

Consulte el apartado de Referencia, al final de esta sección, para ver muestras de los ajustes disponibles.

Para cambiar el ajuste del estilo:

- 1 Mantenga presionado  y presione  una vez. El ajuste del estilo actualmente seleccionado aparece en el visualizador.
- 2 Mantenga presionado  y siga presionando  hasta que aparezca el ajuste deseado en el visualizador.
- 3 Suelte  para aplicar el ajuste del estilo deseado a todos los caracteres del texto.

 *El indicador del estilo se enciende si se selecciona un ajuste que no sea el de NORMAL.*

FUNCIÓN DE SUBRAYADO

Podrá acentuar el texto tachándolo o subrayándolo.

El ajuste inicial para subrayado es OFF, aunque tiene disponibles otros dos ajustes. Si se selecciona un ajuste que no sea el de OFF, se encenderá el indicador de subrayado, situado a la derecha del visualizador.





ACTIVADO

ABC

TACHADO

~~ABC~~

Para cambiar el ajuste del subrayado:

- 1 Mantenga presionado  y presione  una vez. El ajuste del subrayado actualmente seleccionado aparece en el visualizador.
- 2 Mantenga presionado  y siga presionando  hasta que aparezca el ajuste deseado en el visualizador.
- 3 Suelte  para aplicar el ajuste del subrayado deseado a todos los caracteres del texto.

 *El indicador de subrayado se enciende si se selecciona un ajuste que no sea OFF.*

FUNCIÓN DEL TIPO DE CARACTERES

Con la función del tipo de caracteres podrá seleccionar una amplia variedad de tipos de caracteres para su texto.

Los ajustes de tipos de caracteres siguientes están disponibles en la PT-330:

HELSINKI, BRUSSELS, TITLE SAN DIEGO, TITLE CALGARY y TITLE FLORIDA

Los ajustes de tipos de caracteres siguientes están disponibles en la PT-350:



HELSINKI, BRUSSELS, BERMUDA, TITLE SAN DIEGO, TITLE CALGARY, TITLE FLORIDA, TITLE ISTAMBUL y TITLE U.S.

El ajuste inicial del tipo de caracteres es HELSINKI. El ajuste actualmente seleccionado del tipo de caracteres siempre se muestra con los indicadores del tipo de caracteres de debajo del visualizador.



 *Los tipos de caracteres TITLE están sólo disponibles si el texto consta de una sola línea y si se tiene instalada una cinta de 12 mm (1/2") o de 24 mm (1") de ancho. Además, el texto sólo se imprimirá en mayúsculas y no podrá imprimirse verticalmente ni con otros tamaños de caracteres.*

Consulte el apartado de Referencia, al final de esta sección, para ver muestras de los ajustes disponibles.

Para cambiar el ajuste del tipo de caracteres:

1 Mantenga presionado  y presione  una vez. El ajuste del tipo de caracteres actualmente seleccionado aparece en el visualizador.

 *Los indicadores del tipo de caracteres de debajo del visualizador también indican el ajuste del tipo de caracteres actual.*

2 Mantenga presionado  y siga presionando  hasta que aparezca el ajuste deseado en el visualizador y se indique con los indicadores del tipo de caracteres.

3 Suelte  para aplicar el ajuste del tipo de caracteres deseado a todos los caracteres del texto.

REFERENCIA

Ajustes del tipo de caracteres	Muestras de tipos de caracteres	Indicadores del visualizador	
		PT-330	PT-350
HELSINKI	abc	F1	F1
BRUSSELS	abc	F2	F2
BERMUDA	<i>abc</i>	No está disponible en la PT-330	F3
TITLE SAN DIEGO	ABC	Title F3	Title F1
TITLE CALGARY	<i>ABC</i>	Title F4	Title F2
TITLE FLORIDA	ABC	Title F5	Title F3
TITLE ISTANBUL	ABC	No está disponible en la PT-330	Title F4
TITLE U.S.	ABC	No está disponible en la PT-330	Title F5

FUNCIÓN DE MARCOS

Con la función de marcos, podrá seleccionar diversos marcos y funciones destacadas para hacer un diseño más decorativo o una etiqueta con más énfasis.

Los ajustes de marcos siguientes están disponibles en la PT-330:

OFF, SQUARE, ROUND, DOT, CANDY, POINTING, NAME PLATE





Los ajustes de marcos siguientes están disponibles en la PT-350:

OFF, SQUARE, ROUND, DOT, DIAMOND, SLANT, CANDY, POINTING, NAME PLATE, DOG, MOVIEE FILM, DINOSAUR, TELEPHONE, HANDS, WINDOW, BANNER

El ajuste inicial de marco es OFF, aunque hay también otros ajustes. Si se selecciona cualquier ajuste que no sea OFF, se encenderá el indicador de marco, situado a la derecha del visualizador.

Consulte el apartado de Referencia, al final de esta sección, para ver muestras de los ajustes disponibles.











Para cambiar el ajuste del marco:

- 1 Mantenga presionado  y presione  una vez. El ajuste del marco actualmente seleccionado aparece en el visualizador.
- 2 Mantenga presionado  y siga presionando  hasta que aparezca el ajuste deseado en el visualizador.
- 3 Suelte  para aplicar el ajuste del marco deseado a todo el texto.

 El indicador de subrayado se enciende si se selecciona un ajuste que no sea OFF.

REFERENCIA

Ajustes del marco	Muestras de marco	Ajustes del marco	Muestras de marco
OFF	ABC	CANDY	
SQUARE		POINTING	
ROUND		NAME PLATE	

Ajustes del marco	Muestras de marco	Ajustes del marco	Muestras de marco
DOT		DOG (No está disponible en la PT-330)	
DIAMOND (No está disponible en la PT-330)		MOVIE FILM (No está disponible en la PT-330)	
SLANT (No está disponible en la PT-330)		DINOSAUR (No está disponible en la PT-330)	
TELEPHONE (No está disponible en la PT-330)		WINDOW (No está disponible en la PT-330)	
HANDS (No está disponible en la PT-330)		BANNER (No está disponible en la PT-330)	

FUNCIÓN DE CINTA

La función de cinta le permite ajustar el tamaño de los márgenes de los lados izquierdo y derecho del texto.

El ajuste inicial de cinta es ####, aunque hay también disponibles otros cuatro ajustes.

####

(márgenes de 25 mm (1"))

–

(sin márgenes)

#

(márgenes de 4 mm (1/6"))

##



(márgenes de 8 mm (1/3"))

###

(márgenes de 12 mm (1/2"))





 Si se ha instalado una cinta de letras instantáneas (por frotación) una cinta de letras de impresión por calor, el texto se imprimirá con márgenes de 25 mm (1") aunque se seleccione un ajuste distinto para la función de cinta.

Después de imprimir una etiqueta usando el ajuste – de cinta, mantenga presionado

 y presione  una vez para que la cinta avance antes de presionar la palanca de la cuchilla de la cinta para cortarla, porque de lo contrario podrían cortarse algunos de los caracteres impresos.

Después de imprimir empleando los ajustes de cinta #, ##, o ###, presione la palanca de la cuchilla de la cinta para cortar la etiqueta, y emplee entonces unas tijeras para cortar a lo largo de los puntos (:) impresos para centrar el texto dentro de la etiqueta.

Para cambiar el ajuste de la cinta:

- 1 Mantenga presionado  y presione  una vez. El ajuste de la cinta actualmente seleccionado aparece en el visualizador.
- 2 Mantenga presionado  y siga presionando  hasta que aparezca el ajuste deseado en el visualizador.
- 3 Suelte  para aplicar el ajuste de la cinta deseado a todo el texto.

FUNCIÓN DE LA ALINEACIÓN HORIZONTAL

Podrá elegir alinear los caracteres de cada bloque de texto en una de las cuatro formas disponibles. Además, si utilizó la función de longitud para ajustar la longitud de la etiqueta, los bloques se alinearán dentro de la etiqueta de acuerdo con el ajuste de alineación horizontal seleccionado.

El ajuste inicial de la alineación horizontal es LEFT (izquierda), aunque también están disponibles otros tres ajustes.

LEFT	AB CDE FG	RIGHT	AB CDE FG
CENTER	AB CDE FG	JUSTIFY	A B CDE F G

Para cambiar el ajuste de la alineación horizontal:

- 1 Mantenga presionado **Code** y presione **H.Ali** una vez. El ajuste de la alineación horizontal actualmente seleccionado aparece en el visualizador.
- 2 Mantenga presionado **Code** y siga presionando **H.Ali** hasta que aparezca el ajuste deseado en el visualizador.
- 3 Suelte **Code** para aplicar el ajuste de la alineación horizontal deseado a todo el texto.



FUNCIÓN DE IMPRESIÓN VERTICAL

Esta función le permite imprimir los caracteres de su texto verticalmente en toda la longitud de su etiqueta.





El ajuste inicial para impresión vertical es OFF.

ON



 Si se presiona  mientras la función de impresión vertical está ajustada a ON y se tiene seleccionado un tipo de caracteres TITLE, el texto se imprimirá horizontalmente.

Para cambiar el ajuste de la impresión vertical:

- 1 Mantenga presionado  y presione  una vez. El ajuste de la impresión vertical actualmente seleccionado aparece en el visualizador.
- 2 Mantenga presionado  y siga presionando  hasta que aparezca el ajuste deseado en el visualizador.
- 3 Suelte  para aplicar el ajuste de la impresión vertical deseado a todo el texto.

FUNCIÓN DE IMPRESIÓN DE ESPEJO

Con esta función, podrá imprimir el texto de modo que los caracteres puedan leerse desde el lado del adhesivo de la cinta. Si se adhieren etiquetas con impresión de espejo a un vidrio, como pueda ser en un escaparate, o en otro material transparente, podrán leerse correctamente desde el lado opuesto.





 Cuando emplee la función de impresión de espejo, el texto se imprimirá en cinta transparente.

El ajuste inicial para la impresión de espejo es OFF.

ON



Para cambiar el ajuste de la impresión de espejo:

- 1 Mantenga presionado  y presione  una vez. El ajuste de la impresión de espejo actualmente seleccionado aparece en el visualizador.
- 2 Mantenga presionado  y siga presionando  hasta que aparezca el ajuste deseado en el visualizador.
- 3 Suelte  para aplicar el ajuste de la impresión de espejo deseado a todo el texto.

FUNCIÓN DE CÓDIGOS DE BARRAS

La función de códigos de barras, que permite imprimir códigos de barras como parte de las etiquetas, es una de las características más avanzadas de la máquina.

 En esta sección explicaremos cómo introducir un código de barras en el texto. No tiene el propósito de ser una introducción amplia al concepto de los códigos de barras. Para encontrar información más detallada al respecto, consulte uno de los muchos libros disponibles en el mercado.

Puesto que esta máquina no está específicamente diseñada para hacer etiquetas de códigos de barras, es posible que algunos lectores de códigos de barras no puedan leer las etiquetas.

Imprima los códigos de barras con tinta negra sobre fondo blanco.

Cuatro parámetros distintos le permiten crear códigos de barras personalizados.

PARÁMETRO
PROTOCOL

AJUSTES

CODE 39 1-2/5, EAN13, EAN8,
UPC-A, UPC-E*, CODABAR*

*: Sólo disponible en la P-Touch 350.

WIDTH (ancho del código de barras)

LARGE (grande), SMALL (pequeño)

UNDER#\$ (números impresos debajo del código de barras)

ON, OFF



CHECK DIG. (dígito de comprobación)

OFF, ON



Los ajustes iniciales son CODE 39 PROTOCOL, LARGE WIDTH, ON UNDER#\$ y OFF CHECK DIG.



 Recomendamos imprimir los códigos de barras empleando el ajuste de cinta (Tape) #### y el ancho de código de barras LARGE (grande). Los códigos de barras impresos empleando un ajuste Tape más pequeño o un ancho de código de barras SMALL (pequeño) pueden resultar difíciles de leer.

Empleo de la función de códigos de barras:

1 Mantenga presionado  y presione  una vez.

 Si el cursor estaba situado debajo de la marca de código de barras derecha, se visualizarán los datos del código de barras actual.



Una etiqueta sólo puede contener un máximo de cinco códigos de barras. Si ya se han introducido cinco códigos de barras cuando se mantiene presionado  y se presiona , aparecerá el mensaje de error "5 BARS LIMIT".



Para abandonar la función de códigos de barras sin hacer ningún cambio, mantenga presionado  y presione .



2 Introduzca o edite los datos de códigos de barra.

Para cambiar el ajuste del parámetro de código de barras:

3 Presione .

 Para visualizar los datos del código de barras sin cambiar los ajustes de los parámetros, presione .



4 Presione  o  hasta que aparezca el parámetro que usted desee cambiar.



5 Presione  o  hasta que se visualice el ajuste deseado.

6 Repita los pasos 4 y 5 hasta ajustar todos los parámetros como usted desee.

7 Presione .

Para añadir un carácter especial a los datos del código de barras:

8 Presione  o  hasta que el cursor esté debajo del carácter que se encuentra inmediatamente a la derecha de la posición en la que usted desea añadir el carácter especial.

9 Mantenga presionado  y presione .

10 Presione  o  hasta que se visualice el carácter especial deseado.

 Los caracteres especiales siguientes sólo pueden introducirse cuando se emplea los protocolos CODE 39 o CODABAR.

Símbolo	Carácter
1	+
2	\$

11 Presione  para añadir el carácter especial a los datos del código de barras.

Para añadir el código de barras al texto:



12 Presione .

FUNCIÓN DE LA TECLA DE IMPRESIÓN Y AVANCE



Después de haber introducido el texto y de haber seleccionado los ajustes del formato deseado, estará preparado para la impresión.

Para imprimir una etiqueta:

- Presione  una vez. Aparecerá el mensaje “WORKING” en el visualizador justo antes de que se inicie la impresión, y luego se visualizará “COPIES 1/1”.

 Después de imprimir empleando el ajuste – Tape, mantenga presionado  y presione  una vez para que avance la cinta antes de cortarla, porque si no lo hace así podrían quedar cortados algunos de los caracteres impresos.

Para hacer avanzar la cinta:

- Mantenga presionado  y presione  una vez. La cinta avanzará 28 mm (1-1/6”) hacia afuera.

Para cortar la cinta:









- Presione la cinta sobre la palanca de la cuchilla.

 Para evitar daños en la cinta, no trate de cortarla durante la impresión ni el avance. Si presiona demasiado la palanca de la cuchilla, puede romperse.

FUNCIÓN DE NUMERACIÓN





Esta función puede utilizarse para imprimir varias copias del mismo texto mientras se incrementan ciertos caracteres (letras o números) en cada etiqueta impresa.



Para emplear la función de numeración:

- 1 Presione , , , o  para situar el cursor debajo del primer carácter (letra o número) que desee incluir en el campo de numeración.
- 2 Mantenga presionado  y presione  una vez. Aparecerá el mensaje "SELECT FIELD" en el visualizador y parpadeará el primer carácter del campo de numeración.
- 3 Presione  o  hasta que parpadeen todos los caracteres que usted desea incluir en el campo.

 *Para el campo de numeración pueden seleccionarse hasta cinco caracteres. Si se seleccionan más de cinco caracteres, aparecerá el mensaje de error "WRONG SELECT!" en el visualizador.*

Un campo de numeración debe situarse por entero dentro de una línea de texto de un mismo bloque.

- 4 Presione . Aparecerá el mensaje "NUMBER" en el visualizador.
- 5 Presione  o  para seleccionar el número de etiquetas que desee imprimir.
- 6 Presione  para iniciar la impresión de las etiquetas. Aparecerá el mensaje "WORKING" en el visualizador justo antes de iniciarse la impresión, y luego se visualizará el número de cada copia mientras se imprime.
- 7 Presione la palanca de la cuchilla de la cinta para cortar la cinta, y emplee luego unas tijeras para cortar a lo largo de los puntos impresos para separar las etiquetas.

 *Después de imprimir empleando el ajuste 'Tape', mantenga presionado  y presione  una vez para que avance la cinta antes de cortarla, porque de no hacerlo así algunos caracteres impresos podrían quedar cortados.*

FUNCIÓN DE IMPRESIÓN REPETIDA

Esta función le permite imprimir hasta 99 copias del mismo texto.

Para emplear la función de impresión repetida:

- 1 Mantenga presionado **Code** y presione **Repeat** una vez. Aparecerá el mensaje "COPIES" en el visualizador.
- 2 Presione **Home** o **End** para seleccionar el número de etiquetas que desee imprimir.
- 3 Presione **New Block** para empezar a imprimir las etiquetas. Aparecerá el mensaje "WORKING" en el visualizador justo antes de que se inicie la impresión, y luego se visualizará el número de cada copia mientras se imprime.
- 4 Presione la palanca de la cuchilla de la cinta para cortar la cinta, y emplee luego unas tijeras para cortar a lo largo de los puntos impresos para separar las etiquetas.

 Después de imprimir empleando el ajuste 'Tape, mantenga presionado **Code** y presione **Feed** una vez para que avance la cinta antes de cortarla, porque de no hacerlo así algunos caracteres impresos podrían quedar cortados.



FUNCIÓN DE CALENDARIO



(Esta función está sólo disponible en la PT-350.)

La función de calendario le permite imprimir un calendario de cualquier mes desde el año 1901 al 2099.

 Los calendarios deben imprimirse en cinta de 18 mm (3/4") o de 24 mm (1") de ancho.

Para emplear la función de calendario:

1 Mantenga presionado  y presione  una vez.

 Si el texto ya ha sido introducido, aparecerá el mensaje "OK TO CLEAR TEXT BUFFER?" en el visualizador. Para seguir utilizando la función de calendario, presione . Todos los caracteres y formatos de etiqueta, excepto los ajustes de Tape (cinta), Frame (marco), y Mirror (espejo) retornarán a sus ajustes iniciales.



2 Presione  o  para seleccionar YEAR (año) o MONTH (mes).

3 Emplee las teclas numéricas para introducir el año o mes deseados. Para imprimir el calendario de un año entero, introduzca solamente el año. Para imprimir el calendario de un mes solamente, introduzca el año y el mes.

 Si se introduce un año, pero se introduce "0" para el ajuste de MONTH, se imprimirá el calendario de todo el año.

4 Presione  para imprimir la etiqueta. Aparecerá el mensaje de "WORKING" en el visualizador justo antes de la impresión, y luego se visualizará "COPIES 1/1".

 Los calendarios se imprimen empleando los ajustes seleccionados para de Tape (cinta), Frame (marco), y Mirror (espejo).









Después de imprimir empleando el ajuste – Tape, mantenga presionado  y presione  una vez para que avance la cinta antes de cortarla, porque de no hacerlo así algunos caracteres impresos podrían quedar cortados.

FUNCIONES DE LA MEMORIS

Podrá emplear la memoria para almacenar texto que utilice con frecuencia. Estos archivos de texto permanecen en la memoria incluso después de emplear la función de reposición (Clear) para sacar los caracteres del visualizador.





Cuando se almacena cada archivo, se le da un número para poderlo abrir posteriormente con facilidad. En la memoria pueden almacenarse hasta 99 archivos de texto y hasta 2.000 caracteres. Puesto que se llama una copia del archivo de texto almacenado cuando se emplea la función de llamada (Recall), puede editarse o imprimirse sin cambiar el archivo original. Cuando un archivo deja de ser necesario, podrá emplear la función M.Del para borrarlo.

Para almacenar un archivo de texto:









- 1 Mantenga presionado **Code** y presione **Store** .
- 2 Presione **Home**  o **End**  para seleccionar un número de archivo entre el 0 y el 99.
 Si ya se ha almacenado un archivo de texto con el mismo número de archivo seleccionado, podrá ver el resto del archivo presionando **Left Arrow**  o **Right Arrow** .
- 3 Presione **New Block**  para almacenar el archivo y poder llamarlo en cualquier momento.
 Si ya se han almacenado 100 archivos de texto que contienen menos de 2.000 caracteres, aparecerá el mensaje "OVERWRITE?" en el visualizador. Si así ocurre, deberá borrarse un archivo de texto existente antes de poder almacenar el archivo nuevo.

Si ya hay un archivo almacenado con el mismo número que el seleccionado, aparecerá el mensaje "OVERWRITE?" en el visualizador y usted deberá decidir si quiere o no sobrescribirlo (borrarlo para almacenar el nuevo).









Para sobrescribir el archivo almacenado con el archivo nuevo:

- Presione **New Block**  para almacenar el archivo nuevo con el número seleccionado y borrar el que había previamente almacenado.
 Para abandonar la función de almacenamiento (Store) sin almacenar el texto, presione **Clear** **Del**  mantenga presionado **Code** y presione **Store** .









Para llamar un archivo de texto:

- 1 Mantenga presionado **Code** y presione **Recall** . Se visualizarán el número y los primeros caracteres del archivo más recientemente almacenado o llamado.
- 2 Presione **Home**  o **End**  hasta que se visualice el archivo que usted desea llamar.
 Para explorar por el archivo de texto que se visualiza, presione **Left Arrow**  o **Right Arrow** .
- 3 Presione **New Block** .
 Si no se ha introducido texto en el visualizador, se llamará el archivo. Si ya se ha introducido algo de texto en el visualizador, aparecerá "JOINING" y usted deberá decidir si desea unir o sobrescribir el texto visualizado por el del archivo llamado.



Para unir el archivo llamado con el texto visualizado:

- 1 Presione  o  hasta que se visualice "ON".
 Si selecciona "OFF", el archivo de texto almacenado se llamará para sobrescribir el texto visualizado.
- 2 Presione . El archivo de texto almacenado se llama y se inserta en un nuevo bloque en la posición del cursor.
 Para abandonar la función de llamada (Recall) sin llamar el archivo de texto, presione  o mantenga presionado  y presione .





Para borrar un archivo de texto:

- 1 Mantenga presionado  y presione .
 Presione  o  hasta que se visualice el archivo que desea borrar.
- 2 Para explorar el archivo de texto que se visualiza, presione  o .
- 3 Presione . Se visualizará el mensaje "OK TO CLEAR?".
- 4 Presione  para borrar el archivo que se había visualizado.

SOLUCIÓN DE PROBLEMAS

Problema	Remedio
1. El visualizador se queda en blanco después de haber conectado la alimentación de la máquina.	<ul style="list-style-type: none"> • Compruebe que el adaptador de CA esté correctamente enchufado. • Si está empleando pilas alcalinas, compruebe que estén correctamente insertadas. • Si las pilas están gastadas, reemplácelas.
2. La máquina no imprime o los caracteres impresos quedan borrosos.	<ul style="list-style-type: none"> • Compruebe que el casete de cinta se haya insertado correctamente. • Si el casete de cinta está vacío, reemplácelo por otro nuevo. • Asegúrese de que la cubierta del casete de cinta se haya cerrado.
3. Los caracteres impresos no se forman correctamente.	<ul style="list-style-type: none"> • Si está empleando pilas alcalinas, quizás estén gastadas. Pruebe utilizando el adaptador de CA.
4. Aparece una línea horizontal en blanco a través de la etiqueta impresa.	<ul style="list-style-type: none"> • Es posible que haya un poco de polvo en el cabezal de impresión. Extraiga el casete de cinta y emplee un palillo con cabeza de algodón seco para frotar con cuidado el cabezal de impresión (vea la página 5) con movimiento hacia arriba y abajo. • Si todavía queda polvo, humedezca el palillo con cabeza de algodón en alcohol isopropílico (limpieza) y frote suavemente otra vez el cabezal de impresión.
5. Aparecen franjas.	<ul style="list-style-type: none"> • Se ha terminado la cinta. Reemplace el casete de cinta por otro nuevo.
6. La máquina se ha "bloqueado" (es decir, no responde cuando se presiona una tecla).	<ul style="list-style-type: none"> • Desconecte la alimentación de la máquina, y entonces, mientras mantiene presionado  y , vuelva a conectar la alimentación. El texto y los formatos del visualizador y todos los archivos de texto almacenados en la memoria quedan borrados.

LISTA DE MENSAJES DE ERROR

Mensaje de error	Causa	Remedio
4 DIGIT MIN.	<ul style="list-style-type: none"> Este mensaje aparece cuando se introducen menos del mínimo de cuatro dígitos en un código de barras. 	<ul style="list-style-type: none"> Introduzca un mínimo de cuatro dígitos antes de presionar .
4 LINE LIMIT!	<ul style="list-style-type: none"> Este mensaje aparece si ya existen cuatro líneas cuando presiona  o cuando intenta unir un archivo de texto llamado de la memoria con el mensaje actual, causando que el bloque exceda del límite de cuatro líneas. Este mensaje aparece si se sitúa el cursor al principio de un bloque cuando se presiona  para unir dos bloques, resultando en un bloque que contiene un total de más de cuatro líneas. 	<ul style="list-style-type: none"> Límite el número de líneas del bloque actual a cuatro y presione . Ajuste el número total de líneas en los dos bloques de modo que no tengan más de cuatro líneas después de la unión, de lo contrario no intente unir los dos bloques.
5 BARS LIMIT!	<ul style="list-style-type: none"> Este mensaje aparece si ya existen cinco códigos de barras cuando usted presiona  o si intenta unir un archivo de texto llamado de la memoria al mensaje actual, causando que el número de códigos de barras exceda el límite de cinco. 	<ul style="list-style-type: none"> Limite el número de códigos de barras en el mensaje de texto a cinco.

Mensaje de error	Causa	Remedio
5 BLOCK LIMIT!	<ul style="list-style-type: none"> Este mensaje aparece si ya existen cinco bloques cuando usted presiona <small>New Block</small>  o si intenta unir un archivo de texto llamado de la memoria al mensaje actual, causando que el mensaje exceda el límite de cinco bloques. 	<ul style="list-style-type: none"> Limite el número de bloques en el mensaje de texto a cinco.
ABCD AT BEGIN&END	<ul style="list-style-type: none"> Este mensaje aparece cuando se emplea el protocolo de código de barras CODABAR, pero no se ha introducido una letra entre la A y la D al principio y final del código de barras. 	<ul style="list-style-type: none"> Introduzca una letra entre la A y la D al principio y al final del código de barras.
BATTERIES WEAK!	<ul style="list-style-type: none"> Este mensaje aparece cuando las pilas alcalinas instaladas están gastadas. 	<ul style="list-style-type: none"> Reemplace las pilas o emplee el adaptador de CA.
BUFFER EMPTY!	<ul style="list-style-type: none"> Este mensaje aparece si presiona algunas teclas de función, pero sin haber introducido texto en el visualizador. Este mensaje aparece si intenta imprimir, pero sin haber introducido texto en el visualizador. Este mensaje aparece si intenta almacenar un mensaje como archivo de texto, pero sin haber introducido texto en el visualizador. 	<ul style="list-style-type: none"> Introduzca algo de texto antes de iniciar la función. Introduzca texto antes de la impresión. Introduzca texto antes del almacenamiento.

Mensaje de error	Causa	Remedio
BUFFER FULL!	<ul style="list-style-type: none"> • Este mensaje aparece si intenta introducir un carácter, símbolo, código de barras, retorno, nuevo bloque o un espacio cuando ya se han introducido 255 caracteres en el visualizador. • Este mensaje aparece si intenta unir un archivo de texto llamado de la memoria al mensaje actual cuando el visualizador ya está lleno. 	<ul style="list-style-type: none"> • Borre algo del texto existente para poder introducir más texto. • Borre algo de texto antes de poner unir el archivo llamado al mensaje actual.
CAN'T HERE!	<ul style="list-style-type: none"> • Este mensaje aparece si introduce un carácter, símbolo, espacio, retorno, o nuevo bloque mientras el cursor está situado un campo de código de barras. • Este mensaje aparece si se llama un archivo de texto y se une al mensaje actual mientras el cursor está situado un campo de código de barras. 	<ul style="list-style-type: none"> • Mueva el cursor o borre el campo de código de barras antes de introducir el carácter, símbolo, retorno, o nuevo bloque. • Mueva el cursor o borre el campo de código de barras antes de llamar el archivo de texto.
CHANGE ADAPTOR	<ul style="list-style-type: none"> • Este mensaje aparece si se está empleando un adaptador de alta tensión. 	<ul style="list-style-type: none"> • Extraiga el adaptador de alta tensión y conecte el adaptador de 9,0V CA 1,2 A.

Mensaje de error	Causa	Remedio
FIXED SIZE!	<ul style="list-style-type: none"> • Este mensaje aparece si se presiona ^{New Block}  mientras se ha seleccionado un tipo de caracteres Title. • Este mensaje aparece si se tiene instalada una cinta de 6 mm (1/4") o de 9 mm (3/8") mientras se ha seleccionado un tipo de caracteres Title. • Este mensaje aparece si intenta cambiar el tamaño de caracteres mientras se ha seleccionado un tipo de caracteres Title. 	<ul style="list-style-type: none"> • Cambie el tipo de caracteres. • Inserte un casete de cinta que tenga ancho suficiente para poder imprimir el texto del tipo de caracteres Title. • Puesto que el tamaño es fijo, no lo cambie.
INPUT WHOLE CODE	<ul style="list-style-type: none"> • Este mensaje aparece si no se introduce el número de dígitos ajustado mientras se introducen los datos del código de barras. 	<ul style="list-style-type: none"> • Introduzca el número correcto de dígitos o cambie el número de dígitos ajustado en los parámetros de códigos de barras.
INVAL. CHRS!	<ul style="list-style-type: none"> • Este mensaje aparece si se selecciona algún carácter que no es de letras o números en el campo de numeración. 	<ul style="list-style-type: none"> • Seleccione sólo letras y números en el campo de numeración.
LENGTH LIMIT!	<ul style="list-style-type: none"> • Este mensaje aparece si se introduce un carácter, código de barras, espacio, retorno o nuevo bloque que causa que el texto exceda el límite de un metro. 	<ul style="list-style-type: none"> • Borre algo de texto o reduzca el tamaño de los caracteres.
LINE LIMIT!	<ul style="list-style-type: none"> • Este mensaje aparece si el número de líneas del texto es mayor que el número máximo de líneas posible para la cinta instalada. 	<ul style="list-style-type: none"> • Reduzca el número de líneas o instale una cinta más ancha.

Mensaje de error	Causa	Remedio
MEMORY FULL!	<ul style="list-style-type: none"> • Esta máquina puede almacenar unos 2.000 caracteres en su memoria. Este mensaje aparece cuando usted intenta almacenar un mensaje que es demasiado grande para que quepa en el espacio de memoria disponible. 	<ul style="list-style-type: none"> • Deje de intentar almacenar el mensaje o borre un archivo innecesario para crear espacio para el nuevo.
NO FILES!	<ul style="list-style-type: none"> • Este mensaje aparece si intenta llamar o borrar un archivo de texto de la memoria cuando realmente no hay ninguno almacenado. 	<ul style="list-style-type: none"> • Almacene primero un archivo de texto.
NO TAPE!	<ul style="list-style-type: none"> • Este mensaje aparece si intenta imprimir una etiqueta o hacer avanzar la cinta cuando no hay instalado ningún casete de cinta. 	<ul style="list-style-type: none"> • Instale un casete de cinta e inténtelo de nuevo.
RAM PROBLEM!	<ul style="list-style-type: none"> • Este mensaje aparece si hay algún problema con la memoria de acceso aleatorio de la máquina. 	<ul style="list-style-type: none"> • Póngase en contacto con su representante de servicio.
REPLACE BATTERIES!	<ul style="list-style-type: none"> • Este mensaje aparece cuando las pilas alcalinas instaladas están casi gastadas. 	<ul style="list-style-type: none"> • Reemplace las pilas o emplee el adaptador de CA.
ROM PROBLEM!	<ul style="list-style-type: none"> • Este mensaje aparece si hay algún problema con la memoria de sólo lectura de la máquina. 	<ul style="list-style-type: none"> • Póngase en contacto con su representante de servicio.
SYSTEM ERROR!	<ul style="list-style-type: none"> • Este mensaje aparece si hay algún problema con el software de la máquina. 	<ul style="list-style-type: none"> • Póngase en contacto con su representante de servicio.

Mensaje de error	Causa	Remedio
TEXT TOO HIGH!	<ul style="list-style-type: none"> • Este mensaje aparece si el tamaño del texto es más grande que el ancho de la cinta instalada. 	<ul style="list-style-type: none"> • Reduzca el tamaño de los caracteres o instale una cinta más ancha.
TEXT TOO LONG!	<ul style="list-style-type: none"> • Este mensaje aparece si la longitud del texto es mayor que la longitud que se ha ajustado para la etiqueta. 	<ul style="list-style-type: none"> • Borre algo de texto, reduzca el ancho de los caracteres o incremente la longitud ajustada de la etiqueta.
WRONG SELECT	<ul style="list-style-type: none"> • Este mensaje aparece si se seleccionan más de cinco caracteres como el campo numérico. 	<ul style="list-style-type: none"> • Limite el campo numérico a cinco caracteres.

ESPECIFICACIONES

HARDWARE

Dispositivo de entrada:	Teclado de 51 teclas
LCD:	7 × 5 puntos 12 caracteres × 2 líneas 19 indicadores
Cinta de impresión:	Sensible a la presión, base adhesiva, 8 m (26'3") de longitud Cinco anchos disponibles: 6 mm (1/4") 9 mm (3/8") 12 mm (1/2") 18 mm (3/4") 24 mm (1")
Alimentación:	Seis pilas alcalinas AA (AM3, LR6) o adaptador de CA opcional Desconexión automática de la alimentación si no se pulsa ninguna tecla durante 5 minutos
Cabezal de impresión:	128 puntos / 180 dpi
Dimensiones:	178 (An) × 205 (Prf) × 60 (Al) mm (7" × 8 1/6" × 2 23/63")
Peso:	700 g (24,5 oz.) (sin casete de cinta ni pilas instalados)

SOFTWARE

Tamaño de la memoria intermedia:	Máximo de 255 caracteres Una línea - 1 m Máximo de cuatro líneas Máximo de cinco bloques
Tamaño de la memoria:	2.000 caracteres
Tamaño de caracteres:	Cinco tamaños (10, 13, 19, 26, y 38 puntos) + AUTO Todos disponibles en el modo normal y WIDE (ancho)
Tipos de caracteres:	PT-330: Cinco tipos de caracteres incorporados PT-350: Ocho tipos de caracteres incorporados
Estilos de impresión:	Normal, negrilla, perfilado, sólido, sombreado, perfilado + sombreado (todos pueden combinarse con cursiva)

ACCESORIOS

● Accesorios de consumo

Adquiera los casetes de cinta, adaptadores de CA y cuchillas de cinta en el distribuidor autorizado que le quede más cerca. Brother no puede hacerse responsable por los problemas causados por el empleo de accesorios de consumo no autorizados.

Emplee **sólo** cintas Brother TZ con esta máquina. No emplee cintas que no tengan la marca **TZ**.

N.º de producto	Descripción	CANT./PAQUETE	PRECIO
Cintas laminadas de 24 mm (1")			
TZ-151	Caracteres negros sobre adhesivo claro	1	\$23.95
TZ-251	Caracteres negros sobre adhesivo blanco	1	\$23.95
TZ-451	Caracteres negros sobre adhesivo rojo	1	\$23.95
TZ-651	Caracteres negros sobre adhesivo amarillo	1	\$23.95
TZ-252	Caracteres rojos sobre adhesivo blanco	1	\$23.95
TZ-354	Caracteres dorados sobre adhesivo negro	1	\$26.95
TZ-355	Caracteres blancos sobre adhesivo negro	1	\$26.95
Cintas laminadas de 18 mm (3/4")			
TZ-141	Caracteres negros sobre adhesivo transparente	1	\$20.95
TZ-241	Caracteres negros sobre adhesivo blanco	1	\$20.95
TZ-242	Caracteres rojos sobre adhesivo blanco	1	\$20.95
TZ-243	Caracteres azules sobre adhesivo blanco	1	\$20.95
TZ-344	Caracteres dorados sobre adhesivo negro	1	\$24.95
TZ-345	Caracteres blancos sobre adhesivo negro	1	\$23.95
TZ-441	Caracteres negros sobre adhesivo rojo	1	\$20.95
TZ-541	Caracteres negros sobre adhesivo azul	1	\$20.95
TZ-545	Caracteres blancos sobre adhesivo azul	1	\$23.95
TZ-641	Caracteres negros sobre adhesivo amarillo	1	\$20.95
TZ-741	Caracteres negros sobre adhesivo verde	1	\$20.95
TZ-B41	Caracteres negros sobre adhesivo naranja fluorescente	1	\$24.95
TZ-M41	Caracteres negros sobre adhesivo claro (MATE)	1	\$20.95
Cintas laminadas de 12 mm (1/2")			
TZ-131	Caracteres negros sobre adhesivo transparente	1	\$16.95
TZ-231	Caracteres negros sobre adhesivo blanco	1	\$17.95
TZ-232	Caracteres rojos sobre adhesivo blanco	1	\$17.95
TZ-335	Caracteres blancos sobre adhesivo negro	1	\$20.95
Cintas laminadas de 9 mm (3/8")			
TZ-121	Caracteres negros sobre adhesivo transparente	1	\$14.95
TZ-221	Caracteres negros sobre adhesivo blanco	1	\$16.95
TZ-325	Caracteres blancos sobre adhesivo negro	1	\$18.95
TZ-421	Caracteres negros sobre adhesivo rojo	1	\$16.95

N.º de producto	Descripción	CANT./ PAQUETE	PRECIO
Cintas laminadas de 6 mm (1/4")			
TZ-111	Caracteres negros sobre adhesivo transparente	1	\$12.95
TZ-211	Caracteres negros sobre adhesivo blanco	1	\$14.95
TZ-315	Caracteres blancos sobre adhesivo negro	1	\$17.95

Cintas especiales

N.º de producto	Descripción	CANT./ PAQUETE	PRECIO
TZ-SE4	Caracteres negros sobre cinta de seguridad de 18 mm (3/4")	1	\$29.95
TZ-FA3	Caracteres azules sobre cinta de tela de 12 mm (1/2")	1	\$24.95

JUEGO DE MEMBRETES

N.º de producto	Descripción	CANT./ PAQUETE	PRECIO
SK-LB	Juego para hacer sellos para negro grande	1	\$39.95
SK-MB	Juego para hacer sellos para negro medio	1	\$37.95
SH-LB	Estampador adicional para negro grande	1	\$27.95
SH-MB	Estampador adicional para negro medio	1	\$24.95

ADAPTADOR DE CA

N.º de producto	Descripción	CANT./ PAQUETE	PRECIO
AD-60	ADAPTADOR DE CA PARA LA PT-330/350	1	\$24.95

brother®