

Introducing Gemma

Created by lady ada

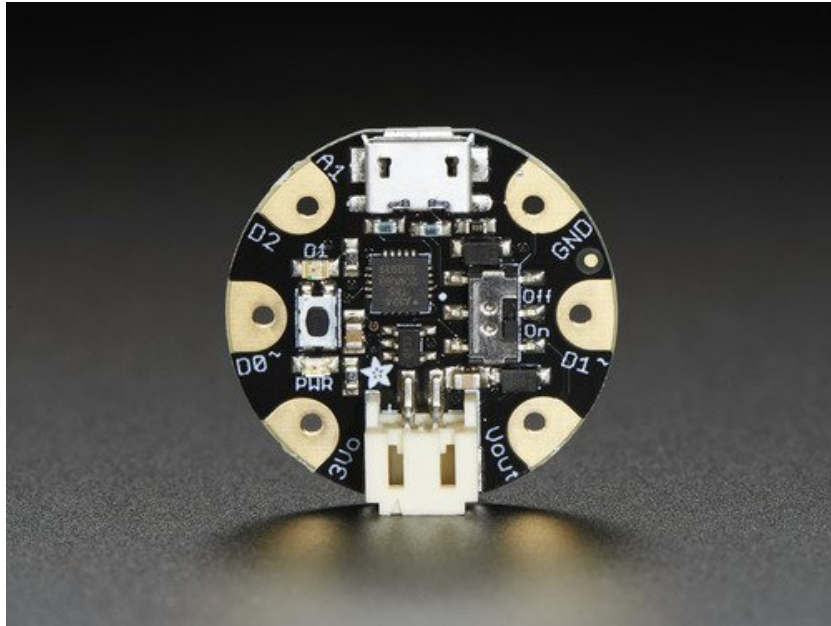

Last updated on 2017-07-26 09:03:35 PM UTC

Guide Contents

Guide Contents	2
Introduction	4
Guided Tour	8
Pinouts	11
JST Battery Input	12
Power Pads	13
Input/Output Pads	13
Secret Reset Pad	14
Windows Driver Installation	15
Manual Driver Installation	17
About the Bootloader	18
Special Notes on using Gemma with Linux	19
How to start the bootloader	20
Setting up with Arduino IDE	21
Arduino IDE Setup	21
Blink!	21
Adafruit Gemma (Black Gemma)	22
Arduino Gemma (Teal Gemma)	23
Get Into Bootloader Mode	24
Something Went Wrong!	25
If you get the error message avrdude: Error: Could not find USBtiny device (0x1781/0xc9f)	25
If you get a lot of red text, errors and also a warning about Verification Failed	25
On Linux if you get the error message "usbtiny_receive: error sending control message: Protocol error (expected 4, got -71)"	26
Programming with Arduino IDE	27
pinMode() & digitalWrite() & digitalRead()	27
analogRead()	28
analogWrite()	28
More...	29
Downloads	30
Datasheets	30

Source code	30
Schematic	30
FAQ	32

Introduction

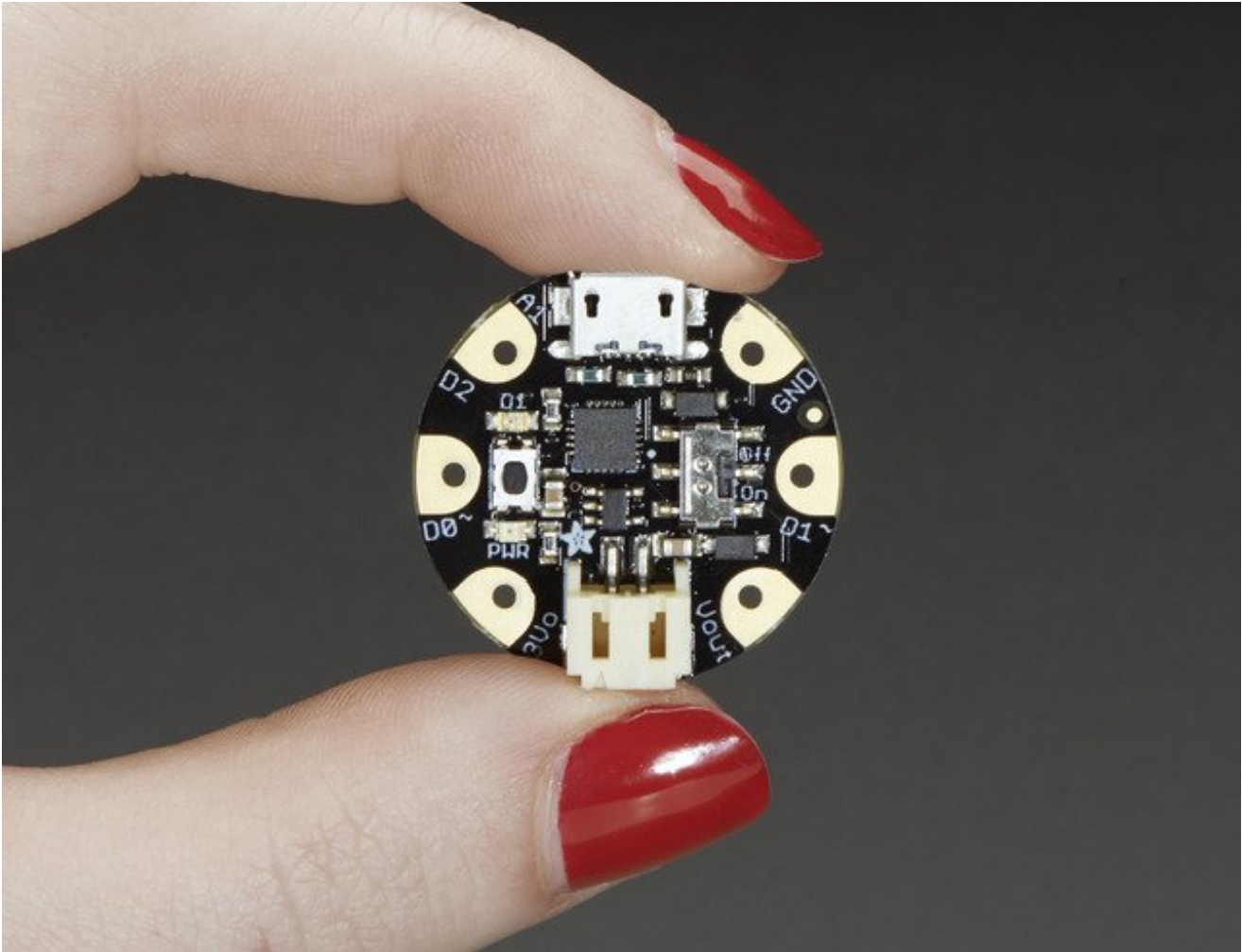

Love Flora but want a bite-sized version? Look no further, Gemma is a tiny wearable platform board with a lot of might in a 1" diameter package. Powered by a Attiny85 and programmable with an Arduino IDE over USB, you'll be able to realize any wearables project!

We wanted to design a microcontroller board that was small enough to fit into any project, and low cost enough to use without hesitation. Perfect for when you don't want to give up your Flora and you aren't willing to take apart the project you worked so hard to design. It's our lowest-cost sewable controller!

The Attiny85 is a fun processor because despite being so small, it has 8K of flash, and 5 I/O pins, including analog inputs and PWM 'analog' outputs. We designed a USB bootloader so you can plug it into any computer and reprogram it over a USB port just like an Arduino

(it uses 2 of the 5 I/O pins, leaving you with 3). In fact we even made some simple modifications to the Arduino IDE so that it works like a mini-Flora. Perfect for small & simple projects the Gemma will be your go-to wearable electronics platform.

Even though you can program Gemma using the Arduino IDE, it's not a fully 100% Arduino-compatible. There are some things you trade off for such a small and low cost microcontroller!

- Gemma does not have a Serial port connection for debugging so the serial port monitor will not be able to send/receive data
- Some computers' USB v3 ports don't recognize the Gemma's bootloader. Simply use a USB v2 port or a USB hub in between
- Gemma is not supported on Linux operating system at this time - try Mac OS or Windows!

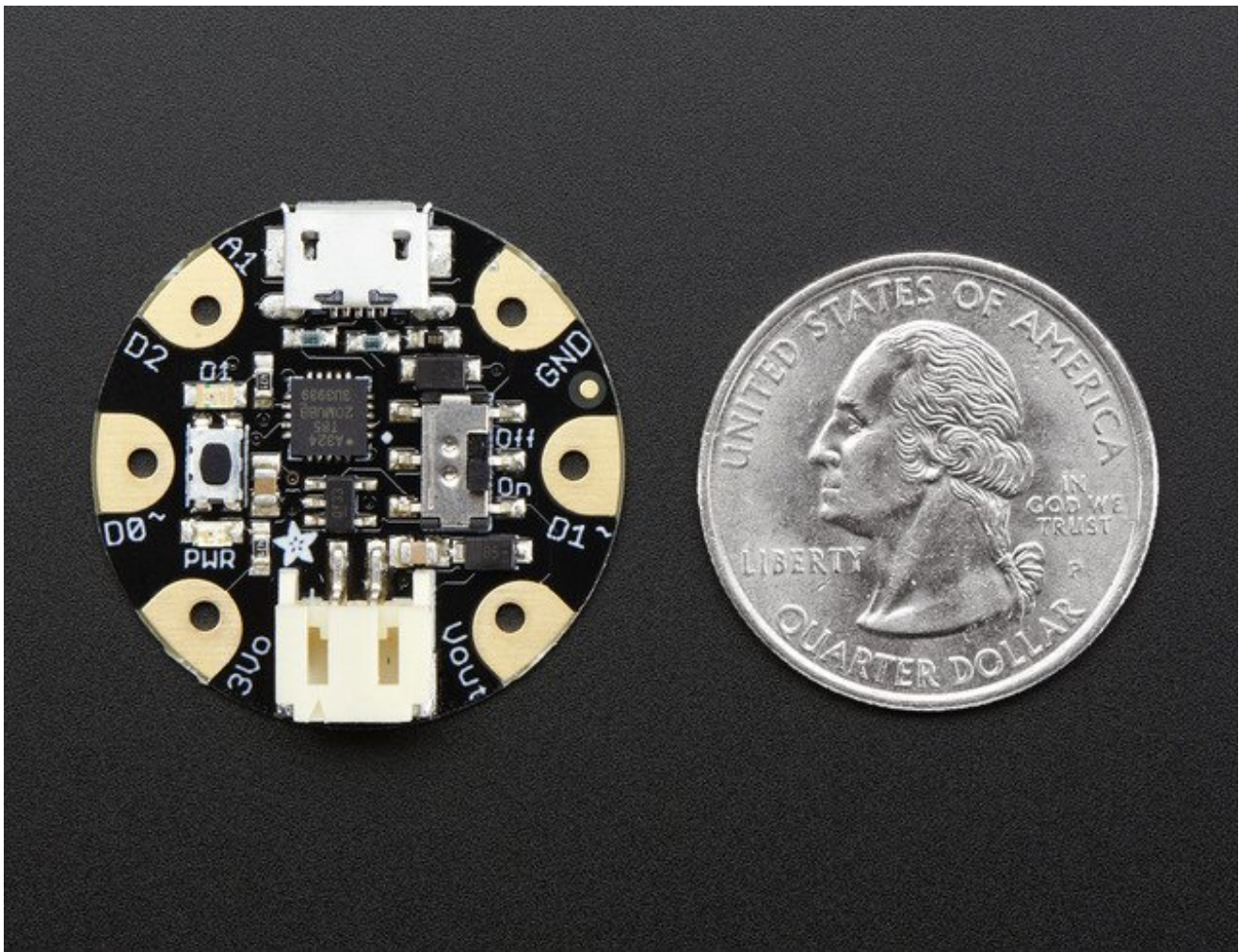

Here are some useful specifications!

- Super small, only 1.1" / 28mm diameter and 0.28" / 7mm thick.

- Easy-to-sew or solder pads for embedding in your wearable project
- Low cost enough, you can use one for every weekend project
- ATtiny85 on-board, 8K of flash, 512 byte of SRAM, 512 bytes of EEPROM
- Internal oscillator runs at 8MHz
- Ultra low power, draws only 9 mA while running
- USB bootloader with a nice LED indicator looks just like a USBtinyISP so you can program it with the Arduino IDE (with a few simple config modifications)
- Mini-USB jack for power and/or USB uploading, you can put it in a box or tape it up and use any USB cable for when you want to reprogram.
- We really worked hard on the bootloader process to make it rugged and foolproof
- ~5.25K bytes available for use (2.75K taken for the bootloader)
- On-board 3.3V power regulator with 150mA output capability and ultra-low dropout. Up to 16V input, reverse-polarity protection, thermal and current-limit protection.
- Power with either USB or external output (such as a battery) - it'll automatically switch over
- On-board green power LED and red pin #1 LED
- Reset button for entering the bootloader or restarting the program.
- 3 GPIO - The 3 independent IO pins have 1 analog input and 2 PWM output as well.
- Hardware I2C capability for breakout & sensor interfacing.

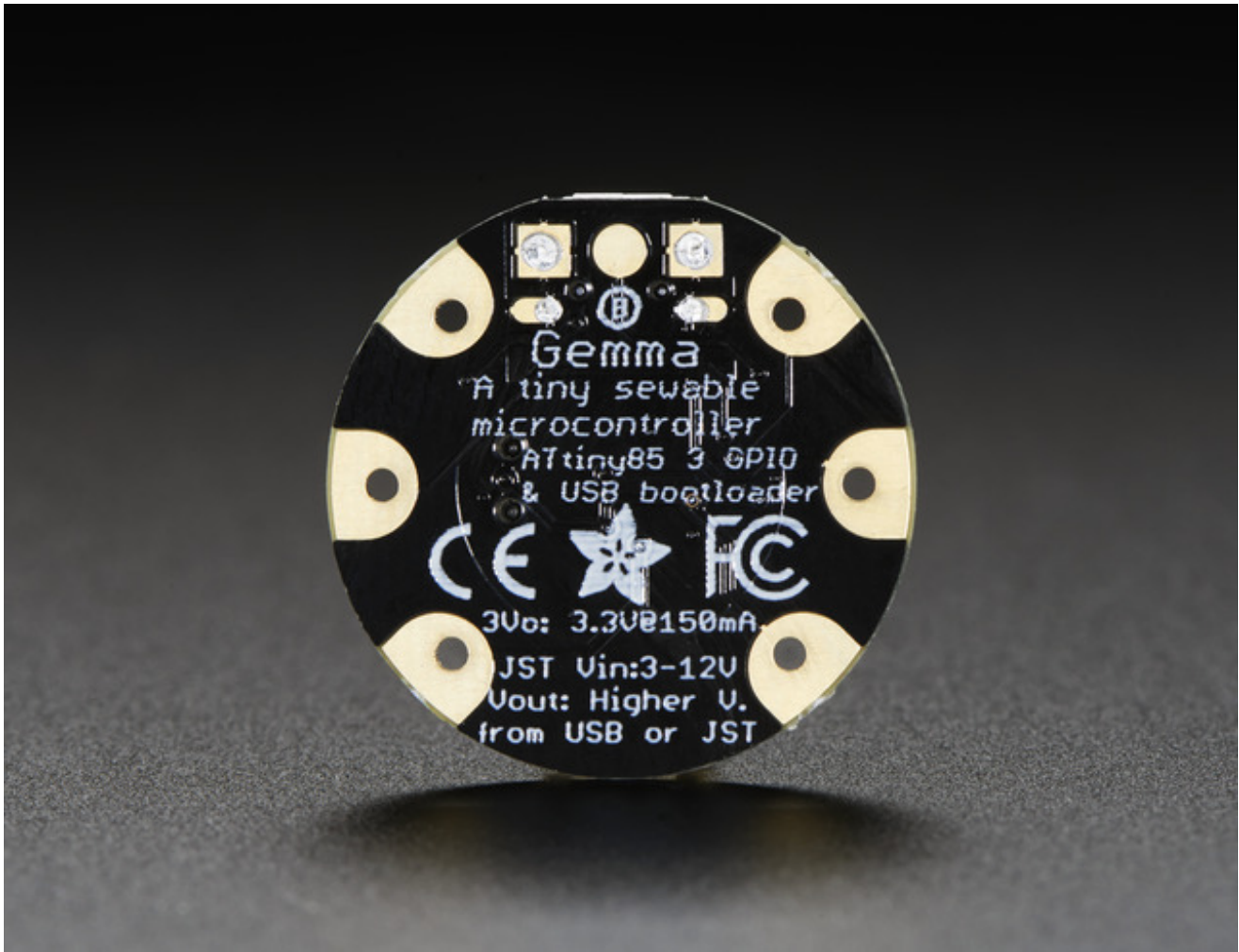

Guided Tour

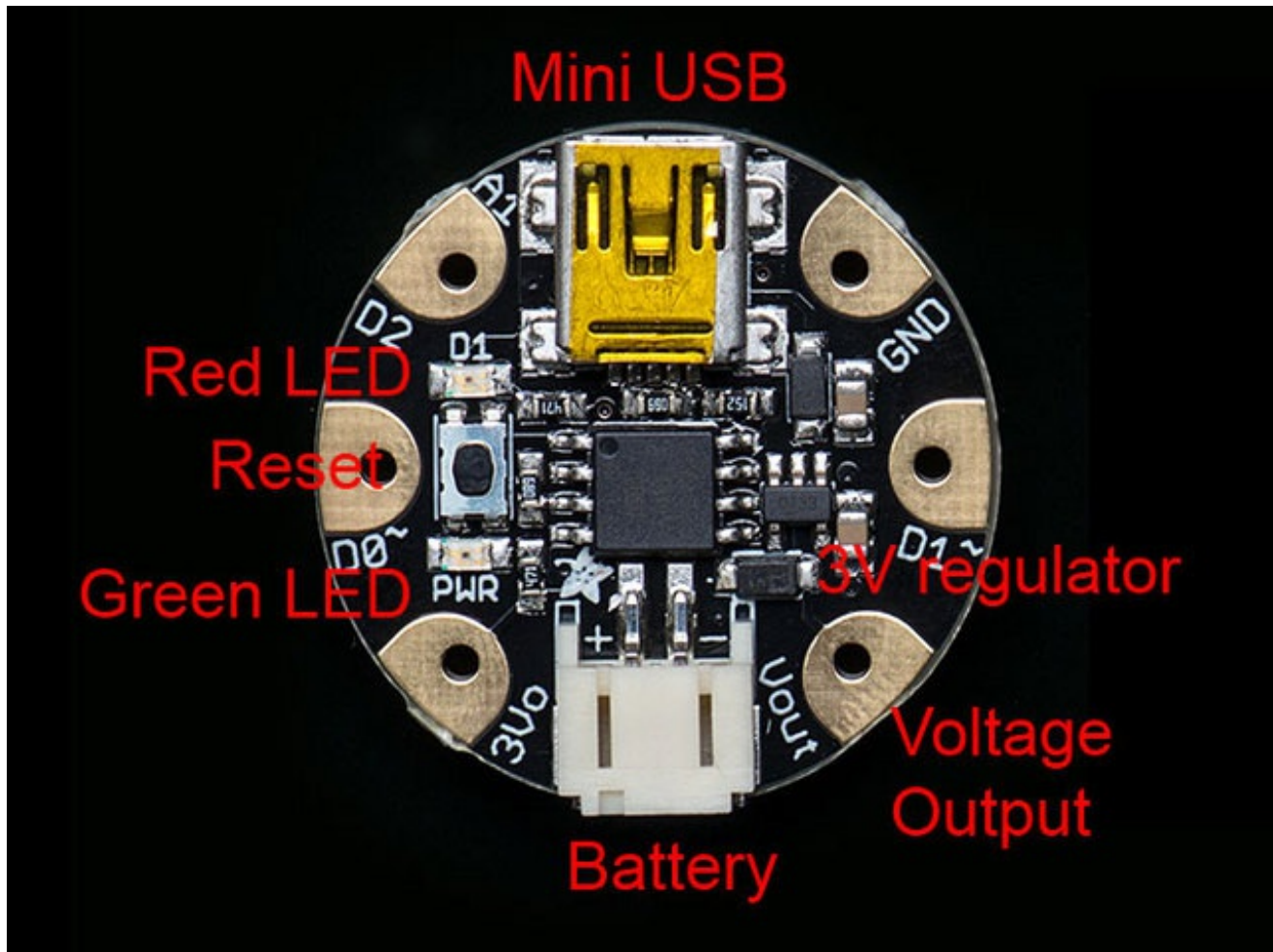

Let me take you on a tour of your Gemma! Each Gemma is assembled here at Adafruit and comes chock-full of good design to make it a joy to use.

- **Mini-B USB connector (on Version 1)** - We went with the tried and true mini-B USB connector for power and/or USB bootloading on our first version of the Gemma
- **Green Power LED** - you'll know that the board is powered up when this bright LED is lit
- **Red #1 LED** - this LED does double duty. Its connected with a series resistor to the digital #1 GPIO pin. It pulses nicely when the Gemma is in bootloader mode, and its also handy for when you want an indicator LED.
- **JST Battery Input** - take your Gemma anywhere and power it from an external battery. This pin can take up 16V DC input, and has reverse-polarity, over-current and

thermal protections. The circuitry inside will use either the battery or USB power, safely switching from one to the other. If both are connected, it will use whichever has the higher voltage. Works great with a Lithium Polymer battery or our 3xAAA battery packs with a JST connector on the end

- **Voltage Output** - This pin will give you either the battery power or USB power, whichever has a higher voltage. Its great when you want to power something like NeoPixels, that might use more than the 150mA available from the onboard regulator
- **3V Regulator Out** - The on-board voltage regulator can supply up to 150mA at a steady 3.3V from up to 16VDC
- **Sewing friendly pads** - You can easily sew to these pads, and they're gold plated so they wont corrode (oxidize). You can also use alligator clips or solder directly to them.
- **GPIO!** - 3 GPIO pins, at 3V logic, check the next section for a detailed pinout guide
- **Reset Button** - an onboard reset button will launch the bootloader when pressed and the Gemma is plugged into a computer. If it is not connected to a computer, it's smart enough to go straight to the program.

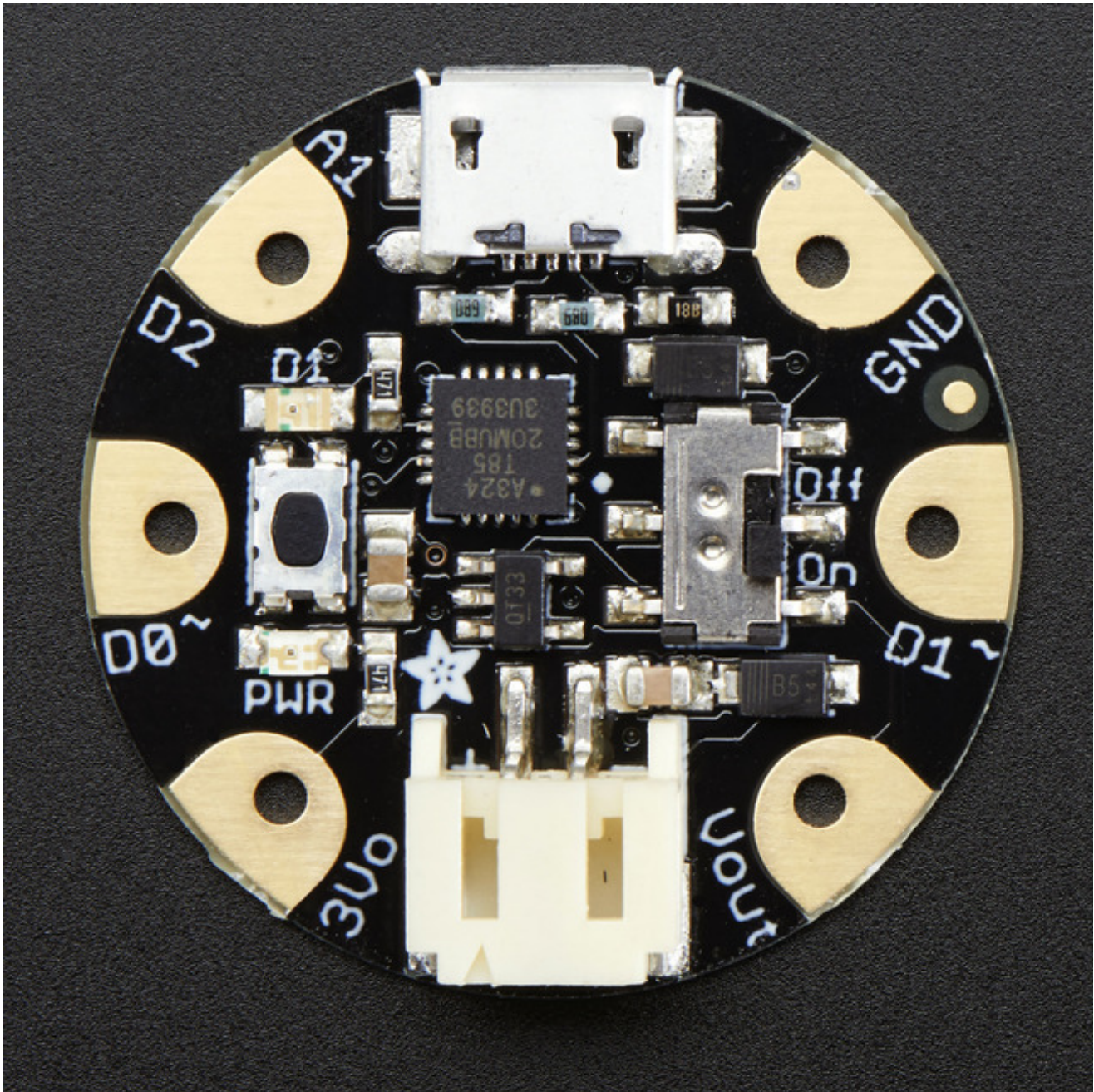

New in Version 2

- **Micro-B USB connector (on Version 2)** - In version 2 we upgraded to a micro USB connector, which is now the standard for all cell phones and other devices. It is used for power and/or USB bootloading on our first version of the Gemma
- **On/Off switch (in version 2 only)** - With the space we saved by moving to a smaller chip and micro USB connector we had enough space to add an on/off slide switch!

Pinouts

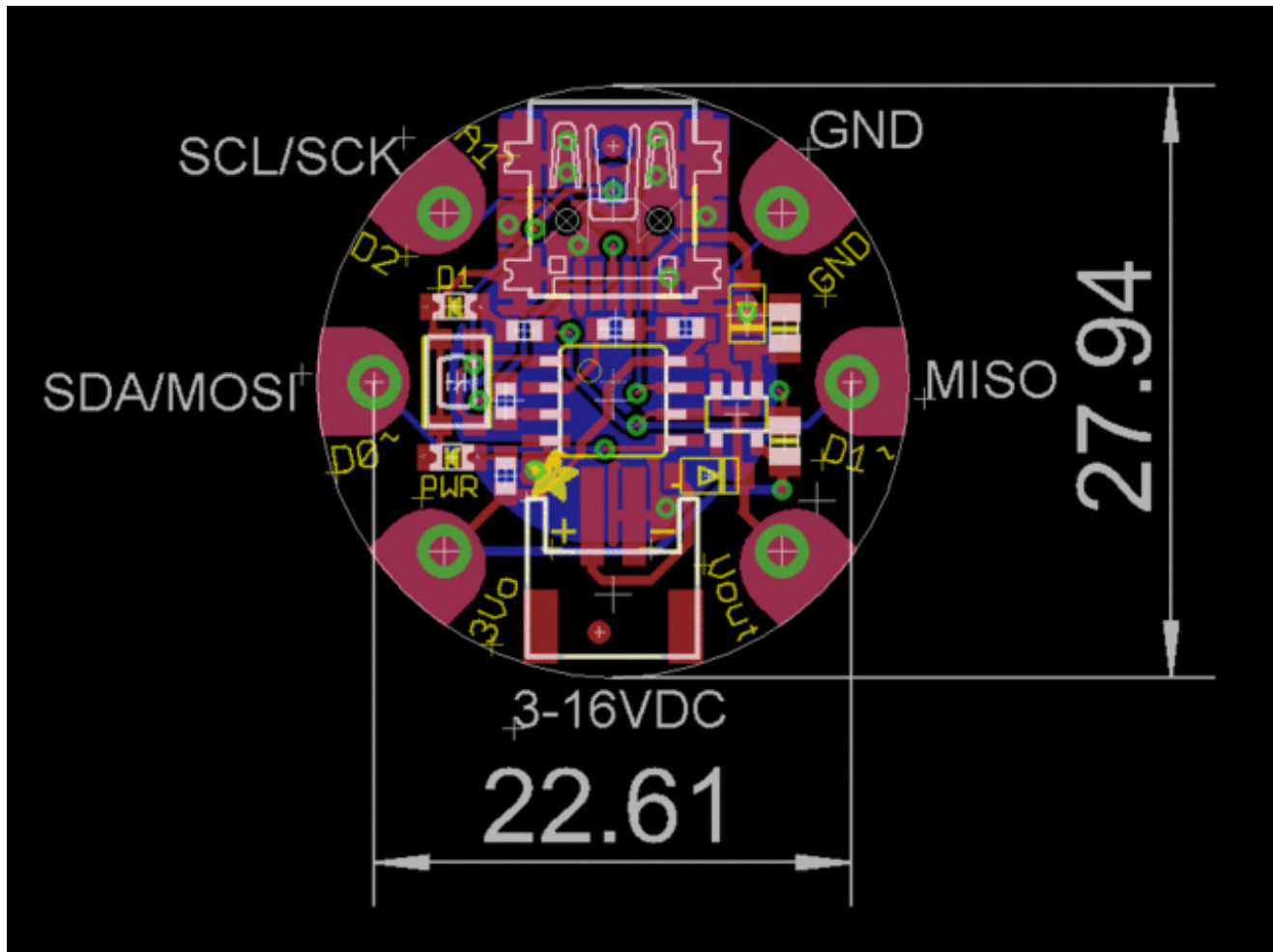

This diagram shows the physical size of the Gemma (diameter in mm) and the distance from pad to pad. The pads are at exact 90 & 45 degree angles except for 0 and 180 which is where the USB/JST connectors go

GEMMA

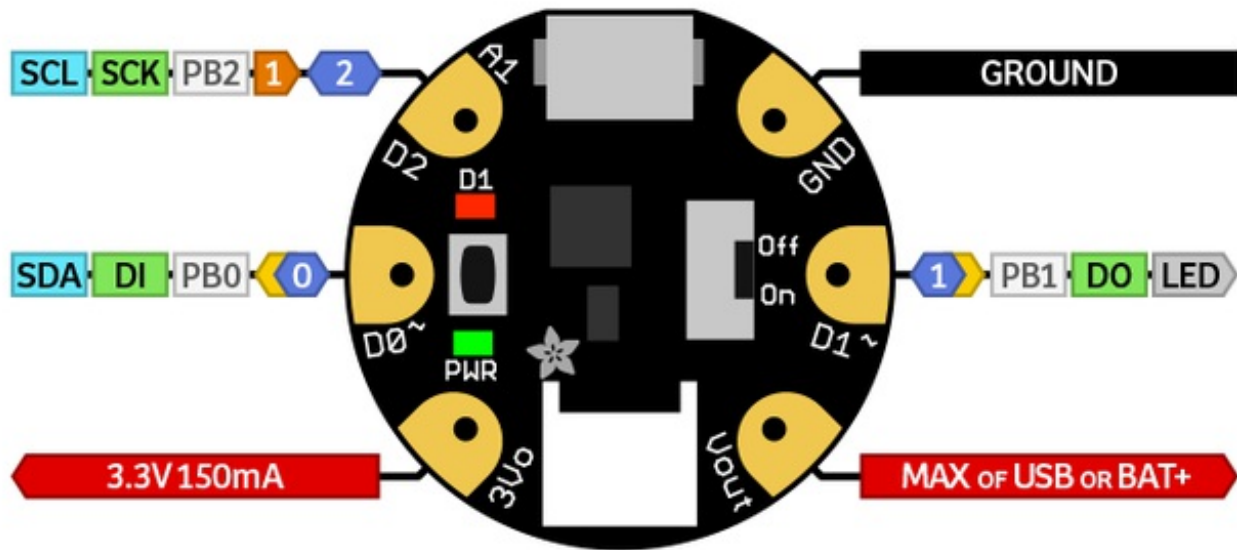

POWER	
GROUND	
DIGITAL READ/WRITE	
ANALOG: READ	WRITE
SERIAL I2C	SPI
PORT PIN	
MISC	

JST Battery Input

There is no battery INPUT pin on the Gemma. You can connect a battery via the JST jack. We have found that [Lipoly batteries](http://adafruit.com/cFB) (<http://adafruit.com/cFB>), [coin-cells](http://adafruit.com/783) (<http://adafruit.com/783>), and [AAA's](http://adafruit.com/727) (<http://adafruit.com/727>) work great. [You can also make your own battery input pack using a plain JST cable](http://adafruit.com/261) (<http://adafruit.com/261>). And use a [JST extension cable if necessary](http://adafruit.com/1131) (<http://adafruit.com/1131>).

You can plug anything from around 4VDC up to 16VDC, but we suggest 4-6V since higher voltages just get wasted as heat. This input is polarity protected. If the green PWR LED lights up, you're good to go. There is no off switch on the Gemma, so unplug or switch off the battery pack when done.

Power Pads

Half of the pads on the Gemma are related to power in and out: **3Vo**, **Vout** and **GND**

- **Vout** - This is a voltage **OUTPUT** pin, it will be connected to *either* the USB power or the battery input, whichever has the higher voltage. This output does not connect to the regulator so you can draw as much current as your USB port / Battery can provide (in general, that's about 500mA)
- **3Vo** - This is the **3.3V OUTPUT** pad from the voltage regulator. It can provide up to 150mA at a steady 3.3V. Good for sensors or small LEDs or other 3V devices.
- **GND** is the common ground pin, used for logic and power. It is connected to the USB ground and the power regulator, etc. This is the pin you'll want to use for any and all ground connections

Input/Output Pads

Next we will cover the 3 GPIO (General Purpose Input Output) pins! For reference you may want to also check out the datasheet-reference above for the core ATtiny85 pin

All the GPIO pins can be used as digital inputs, digital outputs, for LEDs, buttons and switches etc. They can provide up to 20mA of current. Don't connect a motor or other high-power component directly to the pins! [Instead, use a transistor to power the DC motor on/off](http://adafru.it/aUD) (<http://adafru.it/aUD>)

On a Gemma, the GPIO are 3.3V output level, and should not be used with 5V inputs. In general, most 5V devices are OK with 3.3V output though.

The 3 GPIO pins are completely 'free' pins, they are not used by the USB connection so you never have to worry about the USB interface interfering with them when programming

- **Pad #0** - this is connected to **PB0** on the ATtiny85. This pin can be used as a PWM output, and is also used for I2C data, and SPI data input.
- **Pad #1** - this is connected to **PB1** on the ATtiny85. This pin can be used as a PWM output, and is also used for SPI data output. This pin is also connected to the onboard LED (like pin 13 on a regular Arduino).
- **Pad #2** - this is connected to **PB2** on the ATtiny85. This pin can be used as an analog input (known as **Analog A1**), and is also used for I2C clock and SPI clock.

Secret Reset Pad

On the off chance you want to reprogram your Gemma with an AVR burner, the bottom of the board has a large pad that is connected to the Reset pin. We use it for testing and you will likely never need it but it is there if you do.

Windows Driver Installation

Mac and Linux do not require drivers, only Windows folks need to do this step

Before you plug in your board, you'll need to possibly install a driver!

Click below to download our Driver Installer

[Download Adafruit Windows Driver Installer](#)

<http://adafru.it/mai>

Download and run the installer

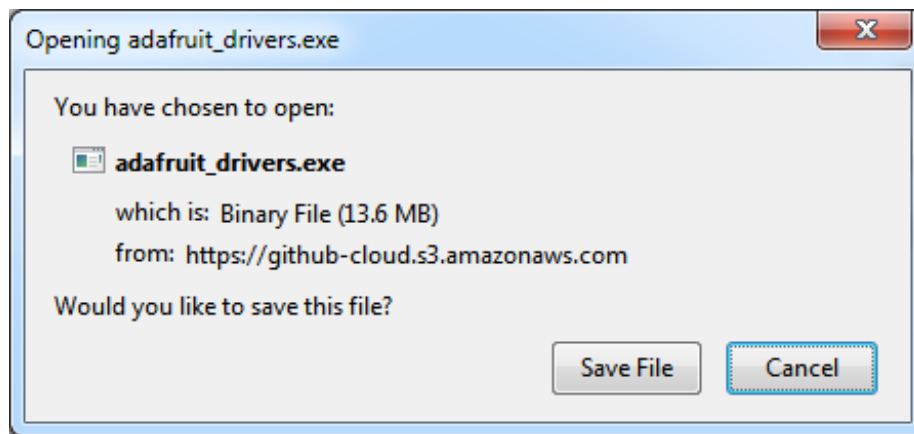

Run the installer! Since we bundle the SiLabs and FTDI drivers as well, you'll need to click through the license

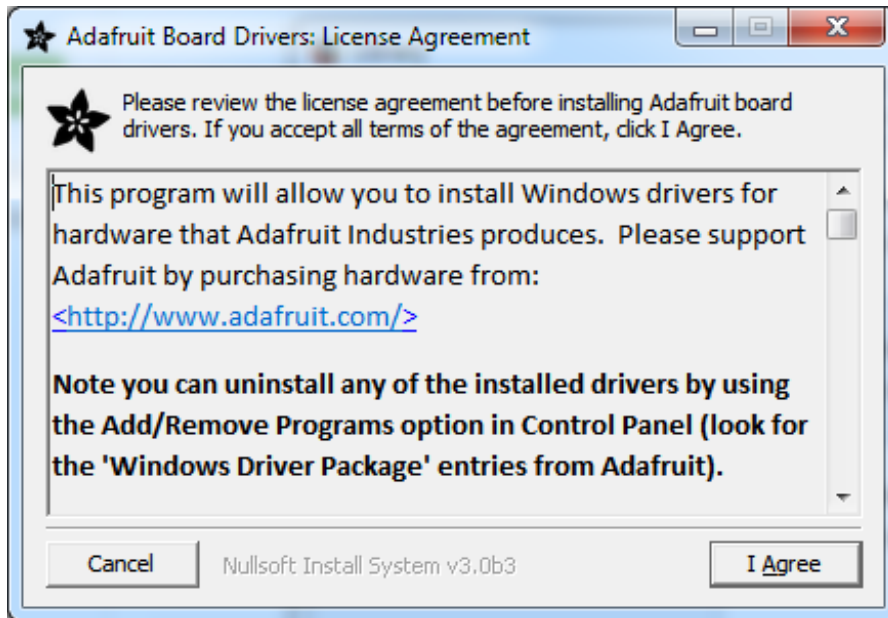

Select which drivers you want to install, we suggest selecting all of them so you don't have to do this again!

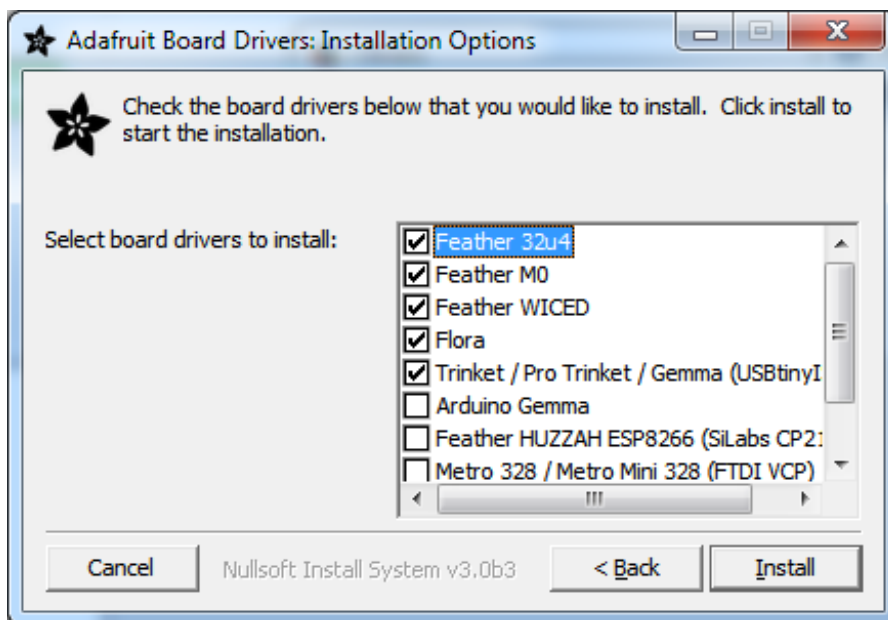

By default, we install the **Feather 32u4** , **Feather M0**, **Flora**, **Gemma M0**, **Circuit Playground** and **Trinket / Pro Trinket / Gemma / USBtinyISP**drivers.

You can also, optionally, install the **Arduino Gemma** (different than the Adafruit Gemma!), Huzzah and Metro drivers

Click **Install** to do the installin'

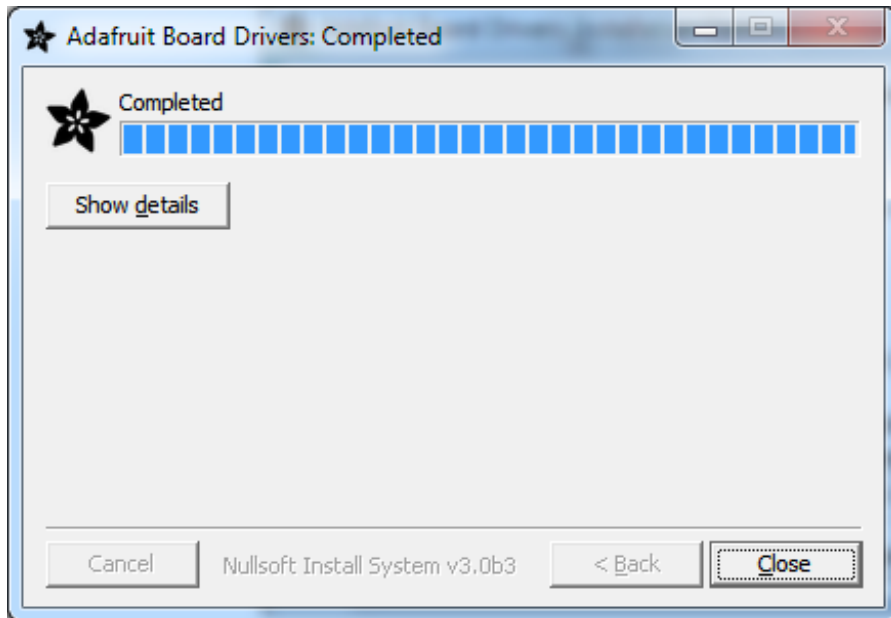

Manual Driver Installation

If windows needs the driver files (inf/cat) for some reason you can get all the drivers in a zip by clicking below:

[Adafruit Windows Drivers](#)

<http://adafru.it/rEY>

And point windows to the **Drivers** folder when it asks for the driver location

About the Bootloader

One of the challenges with the Gemma is that we wanted to have a built-in USB bootloader, but the ATtiny85 doesn't have built-in USB hardware! There are existing USB bootloaders that can work on the 't85 but they use other companies' USB VID/PIDs. Since it not permitted by [the USB developer's group \(http://adafru.it/cDW\)](http://adafru.it/cDW) to use others' VID/PIDs we had to adapt one of these existing bootloaders to use our USB ID, but we also wanted to not have to re-compile avrdude or the Arduino IDE since that's such a pain.

So instead, [Frank \(our awesome engineer with mad USB chops\)\(http://adafru.it/cDX\)](http://adafru.it/cDX) created a USB bootloader that combines the elegance of V-USB with the well-supported and tested nature of the USBtinyISP. This bootloader looks just like a USBtinyISP - and since it uses the unique Adafruit VID/PID we own and that we added to avrdude so long ago, it works with only very minimal configuraton tweaks. No need to recompile anything, whew!

Please note: you cannot use the Adafruit USB VID/PID for your own non-Gemma products or projects. Purchase a USB VID for yourself at <http://www.usb.org/developers/vendor/>

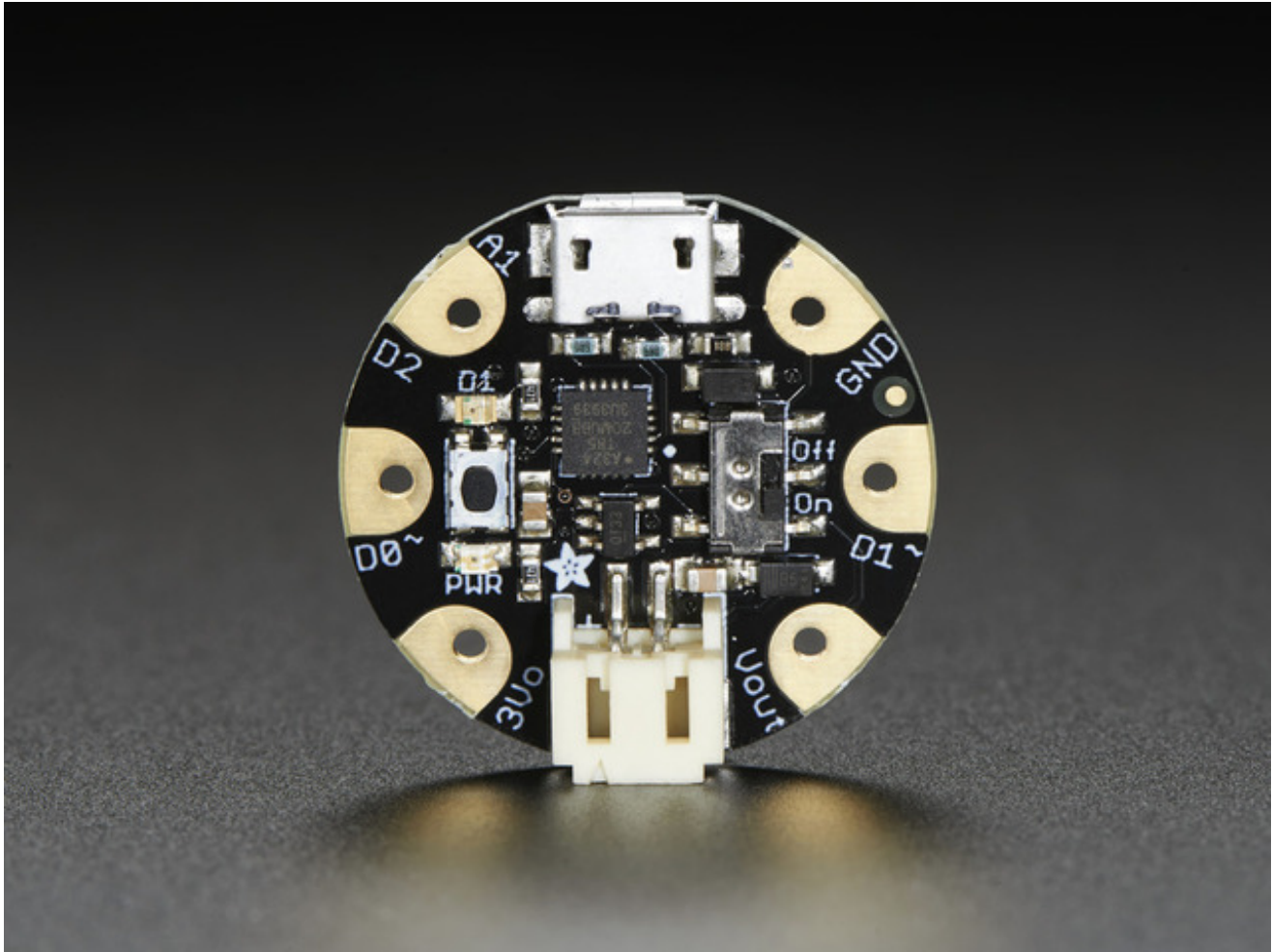

Don't forget to plug in the Gemma via a known-good USB cable to start the process. You should see the green power LED lit and the red bootloading LED pulse indicating that the Gemma is ready to start programming. If you've programmed the Gemma since getting it, you can always get it back to the bootloader state by pressing the small onboard reset button.

Special Notes on using Gemma with Linux

Gemma is not guaranteed supported on Linux operating system at this time - try Mac OS or Windows! However, you can try the following - it does work for some computers
Linux is fairly picky about who can poke and prod at the USB port. You can always run **avrdude** or **Arduino IDE** as root, which will make sure you have the proper permissions. If you want to be super-cool you can add a *udev* rule which will let any user (who is not root) connect to the USBtiny driver. That way you don't have to be root all the time!

Check <http://learn.adafruit.com/usbtinyisp/avrdude#for-linux> (<http://adafru.it/cf3>) for what to add to your udev file.

How to start the bootloader

Before you try to upload code to the Gemma it must be in the Bootloader Mode. That means its listening for a sketch or program to be sent to it

When the Gemma is in bootloader mode, the red LED will be pulsing. Once the red LED stops pulsing, you must press the reset button to re-enter bootloader mode

The Gemma must be connected to a computer via a USB cable to enter bootloader mode.

You can enter the bootloader mode by pressing the little button on the board with your fingernail. The bootloader will 'time out' after 10 seconds, so to re-enter the bootloader mode just re-press the button!

Don't press-and-hold the reset button, be sure to press-and-release!

See the video below for what it looks like to plug it in, have the LED pulse in bootloader mode, time out and then press reset to restart the bootloader. The board shown is a Trinket, which uses the same upload system as Gemma.

Note: Plugging the Gemma into a wall charger will not cause the LED to "pulse". You need a good USB connection.

Setting up with Arduino IDE

Chances are, you picked up a Gemma because it is programmable with the Arduino IDE. Note that the Gemma is not a full Flora or Arduino-compatible, it uses a different (smaller) chip than the Flora, Uno, Mega, Leonardo or Due. However, there are many small sketches and libraries that will work just fine. Some may not even need anything other than pin number changes.

Even though Gemma has a USB connector, it does not have a "Serial Console" capability, so you cannot use Serial to send and receive data to/from a computer!

Arduino IDE Setup

Just follow the steps in the steps in the [Adafruit Arduino IDE setup guide \(http://adafru.it/jAc\)](http://adafru.it/jAc) to easily install a pre-configured Arduino IDE to program Gemma!

[If you are running Arduino IDE 1.6.4 or greater, you can also use this quickstart guide to add in the Gemma plugin \(http://adafru.it/f7X\)](http://adafru.it/f7X)

When you're finished installing the IDE come back to this page to continue the Gemma guide.

Blink!

After installing the Arduino IDE with support for Adafruit's boards you can load a simple blinking LED example to test uploading to Gemma works as expected. Open the Arduino IDE and replace the sketch code with the following blink code:

```
/*  
Blink  
Turns on an LED on for one second, then off for one second, repeatedly.
```

This example code is in the public domain.

To upload to your or Trinket:

- 1) Select the proper board from the Tools->Board Menu (Arduino Gemma if teal, Adafruit Gemma if black)
- 2) Select the uploader from the Tools->Programmer ("Arduino Gemma" if teal, "USBtinyISP" if black Gemma)
- 3) Plug in the Gemma into USB, make sure you see the green LED lit

- 4) For windows, make sure you install the right Gemma drivers
 - 5) Press the button on the Gemma/Trinket - verify you see the red LED pulse. This means it is ready to receive data
 - 6) Click the upload button above within 10 seconds
- */

```
int led = 1; // blink 'digital' pin 1 - AKA the built in red LED

// the setup routine runs once when you press reset:
void setup() {
  // initialize the digital pin as an output.
  pinMode(led, OUTPUT);
}

// the loop routine runs over and over again forever:
void loop() {
  digitalWrite(led, HIGH);
  delay(1000);
  digitalWrite(led, LOW);
  delay(1000);
}
```

Make sure to pick the right version of the Gemma board in the IDE! If you're using the Adafruit Gemma it won't program correctly when selecting the Arduino Gemma option and vice versa! Carefully read the instructions below to pick the right board.

Adafruit Gemma (Black Gemma)

If you're using the **Adafruit Gemma** (with a **black** PCB board) select the **Adafruit Gemma 8MHz** board from the **Tools->Board** menu.

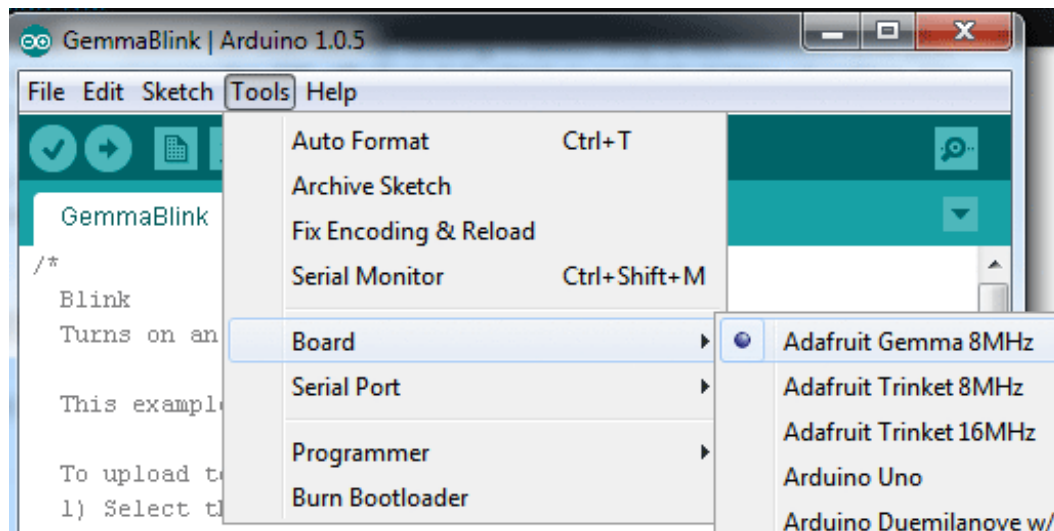

Then, select **USBtinyISP** from the **Tools->Programmer** sub-menu

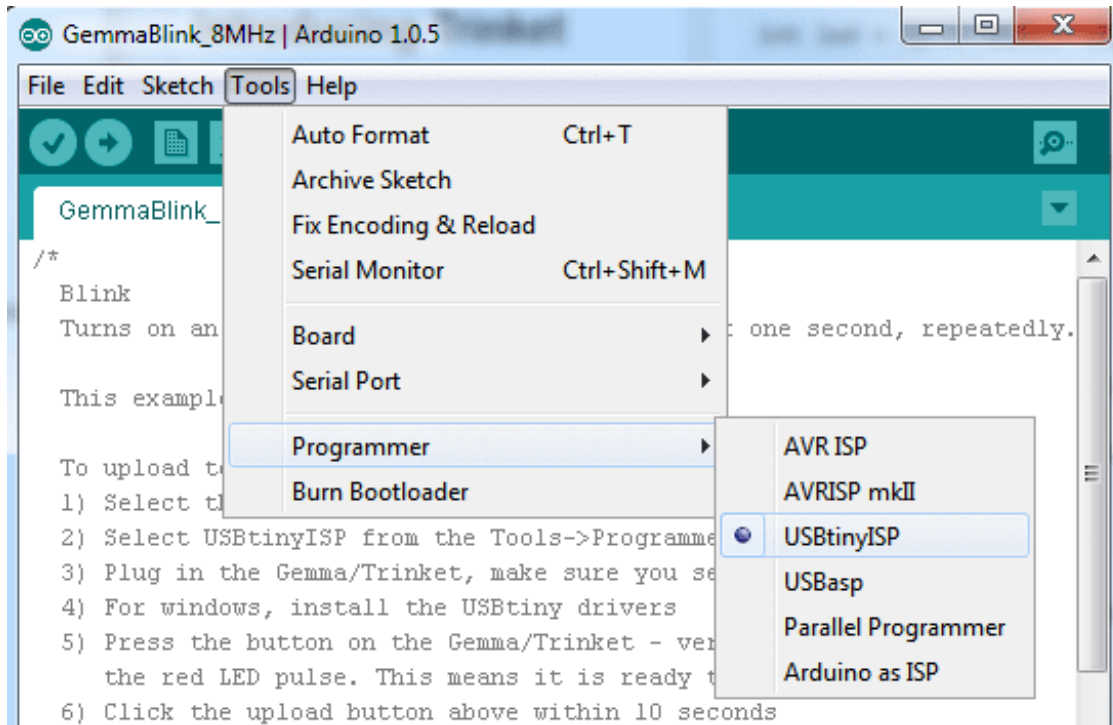

Arduino Gemma (Teal Gemma)

However if you're using the newer **Arduino Gemma** (with a teal PCB board) select the Arduino Gemma board from the **Tools->Boards** menu.

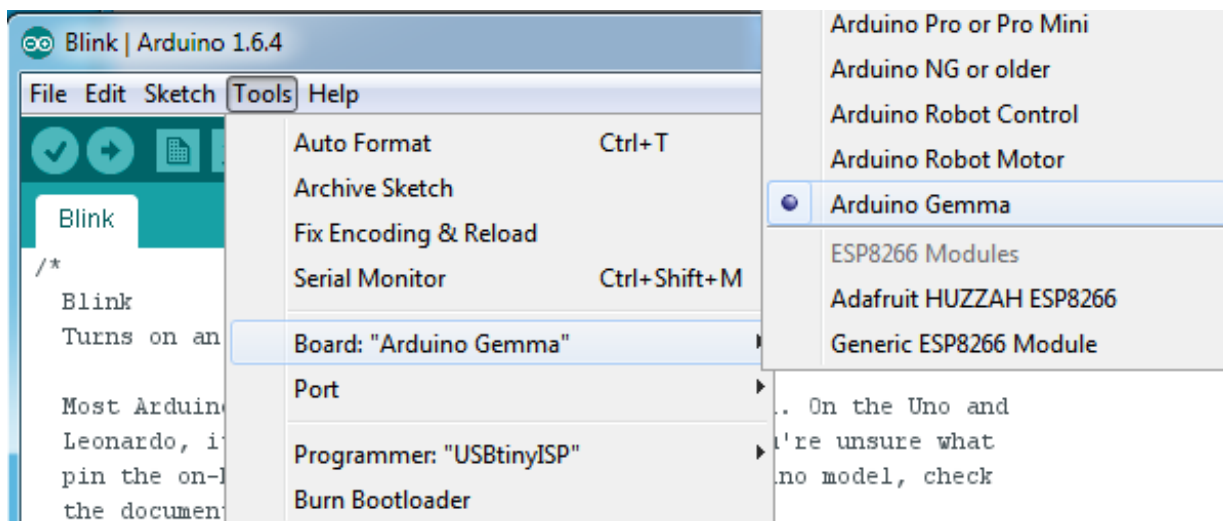

Then select **Arduino Gemma** as the Programmer type

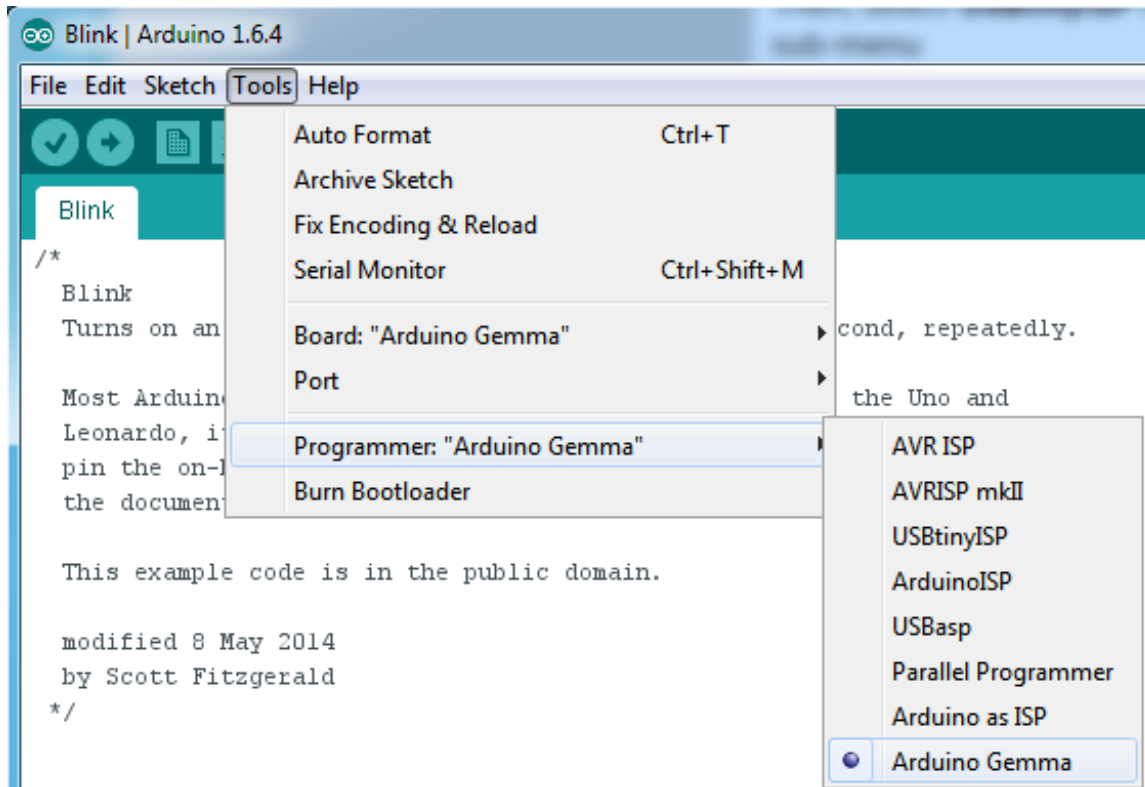

Get Into Bootloader Mode

Plug in the Gemma, make sure you see the green LED lit (power good) and the red LED pulsing. Press the button if the red LED is not pulsing, to get into bootloader mode.

Click the **Upload** button (or select **File->Upload**)

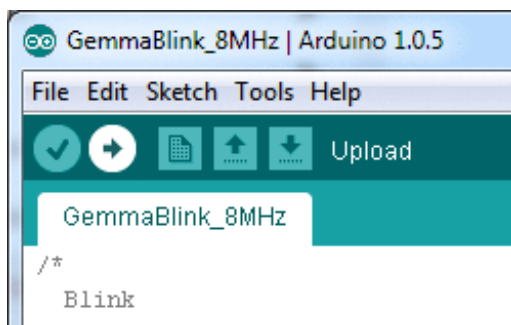

If everything goes smoothly you should see the following (no red error messages) and of course, the red LED on the Gemma will blink on/off once a second

```
int led = 1; // blink 'digital' pin 1 - AKA the built in red LED

// the setup routine runs once when you press reset:

Done uploading.
Binary sketch size: 832 bytes (of a 5,372 byte maximum)

15 Adafruit Trinket 8MHz on COM75
```

Something Went Wrong!

If you get the error message avrdude: Error: Could not find USBtiny device (0x1781/0xc9f)

That means the bootloader wasn't active. Make sure to press the button on the Gemma to activate the bootloader *before* clicking the Upload button.

```
6) Click the upload button above within 10 seconds
*/

int led = 1; // blink 'digital' pin 1 - AKA the built in red LED

Done uploading.
Binary sketch size: 832 bytes (of a 5,372 byte maximum)
avrdude: Error: Could not find USBtiny device (0x1781/0xc9f)

13 Adafruit Trinket 8MHz on COM75
```

If you get a lot of red text, errors and also a warning about Verification Failed

Check that you updated the avrdude.conf file above - if you don't update the description of the Attiny85 in the configure file by replacing it, the IDE wont know to be patient with the

Gemma bootloader and will have many upload errors

```
// the loop routine runs over and over again forever:
void loop() {
  digitalWrite(led, HIGH);
  delay(1000);
  digitalWrite(led, LOW);
  delay(1000);
}
```

Done uploading

```
avrdude: error: usbtiny_receive: usb_control_msg: sending control
message failed, win error: A device attached to the system is not
functioning.

(expected 4, got -5)

avrdude: error: usbtiny_receive: usb_control_msg: sending control
message failed, win error: A device attached to the system is not
functioning.

(expected 4, got -5)
avrdude: verification error, first mismatch at byte 0x0000
      0x20 != 0x00
avrdude: verification error; content mismatch
```

20 Adafrit Trinket 8MHz on COM75

On Linux if you get the error message "usbtiny_receive: error sending control message: Protocol error (expected 4, got -71)"

These can generally be ignored and should not interfere with the program upload.

Unfortunately Linux's USB core is a little flakey communicating with the ATtiny85 processor on the Trinket/Gemma and can cause these errors. If an upload does fail, try it again as it is likely an intermittent issue.

Programming with Arduino IDE

Once you've gotten the basic Blink example to work, you can try some of the other Arduino functions and libraries. We'll be filling out this section with more example code and links to tutorials - this is just to get you started!

pinMode() & digitalWrite() & digitalRead()

You can use pinMode() to make inputs and outputs on any of digital pins #0 thru #20. digitalWrite also works well, and you can also use it with pinMode(INPUT) to activate the internal pull-up resistor on a pin.

For example, to set up digital #0 as an input, with an internal pullup, and then check if it is being pulled to ground via a button or switch and turn on the red LED when it is pressed:

```
/*  
  Button  
  Turns on an LED when a switch connected from #0 to ground is pressed
```

This example code is in the public domain.

To upload to your Gemma or Trinket:

- 1) Select the proper board from the Tools->Board Menu
- 2) Select USBtinyISP from the Tools->Programmer
- 3) Plug in the Gemma/Trinket, make sure you see the green LED lit
- 4) For windows, install the USBtiny drivers
- 5) Press the button on the Gemma/Trinket - verify you see the red LED pulse. This means it is ready to receive data
- 6) Click the upload button above within 10 seconds

```
*/  
  
#define SWITCH 0  
#define LED 1  
  
// the setup routine runs once when you press reset:  
void setup() {  
  // initialize the LED pin as an output.  
  pinMode(LED, OUTPUT);  
  // initialize the SWITCH pin as an input.  
  pinMode(SWITCH, INPUT);  
  // ...with a pullup  
  digitalWrite(SWITCH, HIGH);
```

```

}

// the loop routine runs over and over again forever:
void loop() {
  if (!digitalRead(SWITCH)) { // if the button is pressed
    digitalWrite(LED, HIGH); // light up the LED
  } else {
    digitalWrite(LED, LOW); // otherwise, turn it off
  }
}
}

```

analogRead()

You can read an analog voltage from digital #2 (called **A1**)

For example, to read an analog voltage on pin #2, you would call **analogRead(A1)**

analogWrite()

There are a few PWM outputs on the Trinket, you can call `analogWrite()` on digital #0 and #1

For example, to pulse the built-in LED slowly, upload this code:

```

/*
Pulse
Pulses the internal LED to demonstrate the analogWrite function

```

This example code is in the public domain.

To upload to your Gemma or Trinket:

- 1) Select the proper board from the Tools->Board Menu
- 2) Select USBtinyISP from the Tools->Programmer
- 3) Plug in the Gemma/Trinket, make sure you see the green LED lit
- 4) For windows, install the USBtiny drivers
- 5) Press the button on the Gemma/Trinket - verify you see the red LED pulse. This means it is ready to receive data
- 6) Click the upload button above within 10 seconds

```

*/

int led = 1; // pulse 'digital' pin 1 - AKA the built in red LED

```

```
// the setup routine runs once when you press reset:
void setup() {
  // initialize the digital pin as an output.
  pinMode(led, OUTPUT);
}

// the loop routine runs over and over again forever:
void loop() {
  for (int i=0; i<256; i++) {
    analogWrite(led, i); // PWM the LED from 0 to 255 (max)
    delay(5);
  }
  for (int i=255; i>=0; i--) {
    analogWrite(led, i); // PWM the LED from 255 (max) to 0
    delay(5);
  }
}
```

More...

We also know the following libraries work:

- [Adafruit NeoPixel \(http://adafru.it/aZU\)](http://adafru.it/aZU) - control up to ~150 Neopixels via a Trinket!
- SoftwareSerial - the built in SoftSerial library can (at least) transmit data on any digital pin.
- More as we do more testing and verification!

Downloads

Datasheets

- [Datasheet for the onboard regulator used \(MIC5225 3.3V\)](http://adafru.it/rEI) (<http://adafru.it/rEI>)
- [Webpage for the ATtiny85, the microcontroller used in the Gemma](http://adafru.it/cE5) (<http://adafru.it/cE5>)
- [EagleCAD PCB files on GitHub](http://adafru.it/rEJ) (<http://adafru.it/rEJ>)
- [Fritzing object in Adafruit Fritzing Library](http://adafru.it/aP3) (<http://adafru.it/aP3>)

Source code

[Original code for the Trinket/Gemma bootloader on github](http://adafru.it/cE6) (<http://adafru.it/cE6>)

We do not offer any support for this code, it is released as-is!

Please note: you cannot use the Adafruit USB VID/PID for your own non-Trinket/Gemma products or projects. Purchase a USB VID for yourself at <http://www.usb.org/developers/vendor/>

Schematic

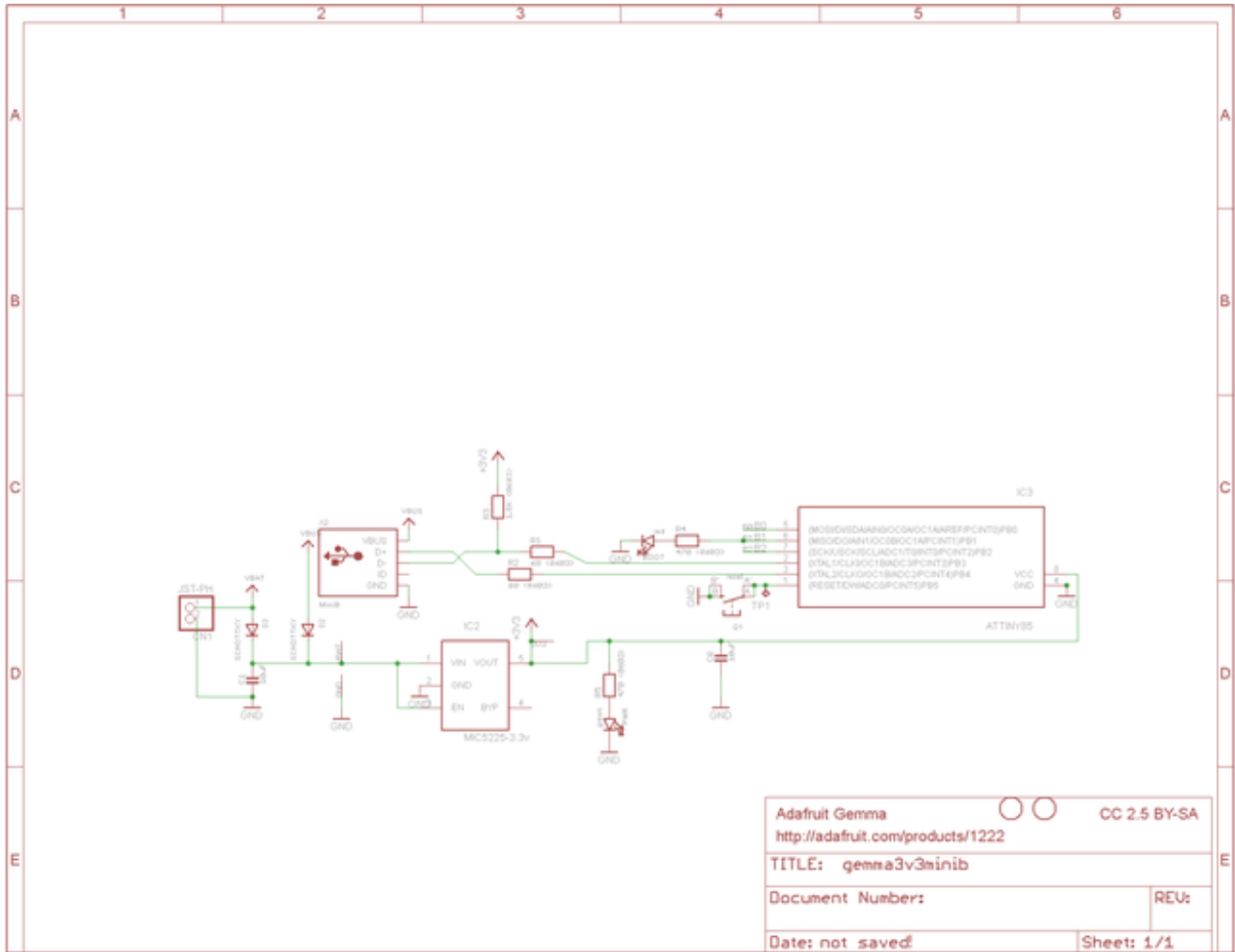

FAQ

When uploading with the Arduino IDE, I get a lot of "(expected 4, got -5)" warnings and then "avrdude: verification error; content mismatch"

[Check that you followed the instructions for updating the Arduino IDE, including replacing the old avrdude.conf \(http://adafru.it/cEY\)](http://adafru.it/cEY)- this step is not optional!

Hmm I'm still having problems with Arduino/Avrdude - and I definitely did the required updates

One fix that works for some people is to edit **avrdude.conf** and set the

```
chip_erase_delay = 900000;
```

under the **ATTiny85** heading to

```
chip_erase_delay = 400000;
```

That is, a shorter delay.

Can Gemma drive Neopixels (strips, squares, etc)? How many?

Yes! Gemma was designed to drive short segments of NeoPixels. There is enough RAM on the attiny85 to drive 100 pixels, but depending on program RAM usage you may have to scale back to 60 or 40.

To use with neopixels:

1. Connect the + power line of the strip to **Vout** on the Gemma, or to a separate 4-7VDC power source such as a 3 or 4 pack of AA batteries.
2. Connect the - common ground to the battery pack (if being used) and also to the Gemma **GND** pin
3. Connect the data in line to Gemma #1 - this will let you also see when data is being sent because the #1 red LED will flicker. You can use other pins but start with #1 since its easiest to debug and use
4. [Install the NeoPixel library as detailed in our Uber Guide \(http://adafru.it/cEz\)](http://adafru.it/cEz), and change the **PIN** to **1** (its 6 by default)
5. Upload and enjoy!

Can Gemma use the Flora Lux/Compass/Accelerometer/Color/GPS Sensors?

Maybe! We think we can get Gemma working with some of the basic sensors, but at this moment we don't have tutorials or examples, Flora code will not compile directly for the Gemma since the processors are different. Right now we think Gemma is best suited for

basic buttons/LEDs/Neopixels type stuff

Can Gemma drive your Adafruit I2C LED Backpacks for 7-segment/matrix displays?

Short answer: yes! Check out [http://learn.adafruit.com/tap-tempo-](http://learn.adafruit.com/tap-tempo-trinket)

[trinket \(http://adafru.it/cEA\)](http://adafru.it/cEA) for a tutorial on driving the 7-segment displays. Long answer:

we think there's not enough space for all of the fonts for the 8x8 so you might be able to drive the 8x8 matrix in 'raw' mode (see the HT16K33 example sketch in the LEDBackpack Library) but unfortunately not with built-in font support.

That tutorial also shows how to use the TinyM I2C driver, which works great on the ATtiny85, and adapt other existing libraries for the Gemma/Trinket

Can Gemma drive a Servo?

Yup! In fact you can use 3 servos as long as they are powered by a good 5V supply [check out this guide for more details \(http://adafru.it/cFC\)](http://adafru.it/cFC)

Gemma runs at 8MHz, but I really need it to run at 16 MHz, is this possible?

It is possible to run the Gemma at 16MHz, but the processor is not specified for 16MHz at 3.3V logic so it is considered overclocking!

However, the AVR series is pretty forgiving for overclocking, so *you may be able to run the 3V Gemma at 16 MHz*. Note that this is still overclocking, your code may run flakey or not at all! Overclocking should not damage the AVR, but we still recommend sticking with 8 MHz only if you can get away with it!

[To run at 16Mhz, use the Trinket 16Mhz board definition and modify your sketch as described here. \(http://adafru.it/cFD\)](http://adafru.it/cFD)